

Final

Water Quality Management Plan

For:

WattEV

1388 S. "E" Street

(formerly 1380 S. "E" Street)

San Bernardino, CA 92408

APN(s): 0141-252-08

Prepared for:

3900 Main Street
City of Riverside
Riverside, CA 92522

(951) 826-5311

Prepared by:



234 North Arrowhead Avenue

San Bernardino, CA 92408

(909) 885-3806

Approval Date: _____

Project Owner's Certification

This Water Quality Management Plan (WQMP) has been prepared for City of Riverside by Bonadiman & Associates, Inc. The WQMP is intended to comply with the requirements of the City of San Bernardino and the NPDES Area wide Stormwater Program requiring the preparation of a WQMP. The undersigned, while it owns the subject property, is responsible for the implementation of the provisions of this plan and will ensure that this plan is amended as appropriate to reflect up-to-date conditions on the site consistent with San Bernardino County's Municipal Storm Water Management Program and the intent of the NPDES Permit for San Bernardino County and the incorporated cities of San Bernardino County within the Santa Ana Region. Once the undersigned transfers its interest in the property, its successors in interest and the city/county shall be notified of the transfer. The new owner will be informed of its responsibility under this WQMP. A copy of the approved WQMP shall be available on the subject site in perpetuity.

"I certify under a penalty of law that the provisions (implementation, operation, maintenance, and funding) of the WQMP have been accepted and that the plan will be transferred to future successors."

Project Data			
Permit/Application Number(s):	THR23-012	Grading Permit Number(s):	LD2300006
Tract/Parcel Map Number(s):		Building Permit Number(s):	
CUP, SUP, and/or APN (Specify Lot Numbers if Portions of Tract):			APN: 0141-252-08
Owner's Signature			
Owner: City of Riverside			
Title	Owner		
Representative			
Address	3900 Main Street Riverside CA 92522		
Email			
Telephone #	(951) 826-5311		
Signature		Date	

Preparer's Certification

Project Data			
Permit/Application Number(s):	THR23-012	Grading Permit Number(s):	LD2300006
Tract/Parcel Map Number(s):		Building Permit Number(s):	
CUP, SUP, and/or APN (Specify Lot Numbers if Portions of Tract):			APN: 0141-252-08

“The selection, sizing and design of stormwater treatment and other stormwater quality and quantity control measures in this plan were prepared under my oversight and meet the requirements of Regional Water Quality Control Board Order No. R8-2010-0036.”

Engineer: James T. Stanton		PE Stamp Below
Title	Vice President of Engineering	
Company	Joseph E. Bonadiman & Associates, Inc.	
Address	234 North Arrowhead Avenue San Bernardino, CA 92408	
Email	jts@bonadiman.com	
Telephone #	(909) 885-3806	
Signature		
Date	4/7/23	
Rev. 5/23/24 - Official address of 1388 S E Street replaced as applicable		

Table of Contents

Section 1 Discretionary Permits	1-1
Section 2 Project Description	2-1
2.1 Project Information.....	2-1
2.2 Property Ownership / Management	2-2
2.3 Potential Stormwater Pollutants	2-3
2.4 Water Quality Credits	2-4
Section 3 Site and Watershed Description	3-1
Section 4 Best Management Practices	4-1
4.1 Source Control BMP	4-1
4.1.1 Pollution Prevention.....	4-1
4.1.2 Preventative LID Site Design Practices	4-6
4.2 Project Performance Criteria	4-7
4.3 Project Conformance Analysis.....	4-12
4.3.1 Site Design Hydrologic Source Control BMP	4-14
4.3.2 Infiltration BMP	4-16
4.3.3 Harvest and Use BMP	4-18
4.3.4 Biotreatment BMP	4-19
4.3.5 Conformance Summary.....	4-23
4.3.6 Hydromodification Control BMP.....	4-24
4.4 Alternative Compliance Plan (if applicable).....	4-25
Section 5 Inspection & Maintenance Responsibility Post Construction BMPs	5-1
Section 6 WQMP Attachments	6-1
6.1 Site Plan and Drainage Plan	6-1
6.2 Electronic Data Submittal.....	6-2
6.3 Post Construction	6-3
6.4 Other Supporting Documentation	6-4

Forms

Form 1-1 Project Information	1-1
Form 2.1-1 Description of Proposed Project	2-1
Form 2.2-1 Property Ownership/Management	2-2
Form 2.3-1 Pollutants of Concern	2-3
Form 2.4-1 Water Quality Credits	2-4
Form 3-1 Site Location and Hydrologic Features	3-1
Form 3-2 Hydrologic Characteristics	3-2
Form 3-3 Watershed Description.....	3-3
Form 4.1-1 Non-Structural Source Control BMP	4-2
Form 4.1-2 Structural Source Control BMP	4-4
Form 4.1-3 Site Design Practices Checklist	4-6
Form 4.2-1 LID BMP Performance Criteria for Design Capture Volume	4-7
Form 4.2-2 Summary of HCOC Assessment.....	4-8
Form 4.2-3 HCOC Assessment for Runoff Volume	4-9
Form 4.2-4 HCOC Assessment for Time of Concentration	4-10
Form 4.2-5 HCOC Assessment for Peak Runoff.....	4-11
Form 4.3-1 Infiltration BMP Feasibility	4-13
Form 4.3-2 Site Design Hydrologic Source Control BMP	4-14
Form 4.3-3 Infiltration LID BMP.....	4-17
Form 4.3-4 Harvest and Use BMP	4-18
Form 4.3-5 Selection and Evaluation of Biotreatment BMP	4-19
Form 4.3-6 Volume Based Biotreatment – Bioretention and Planter Boxes w/Underdrains	4-20
Form 4.3-7 Volume Based Biotreatment- Constructed Wetlands and Extended Detention	4-21
Form 4.3-8 Flow Based Biotreatment	4-22
Form 4.3-9 Conformance Summary and Alternative Compliance Volume Estimate	4-23
Form 4.3-10 Hydromodification Control BMP	4-24
Form 5-1 BMP Inspection and Maintenance	5-1

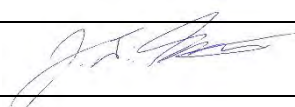
Section 1 Discretionary Permit(s)

Form 1-1 Project Information					
Project Name		WattEV 1388 S. "E" Street San Bernardino, CA 92408			
Project Owner Contact Name:		City of Riverside			
Mailing Address:	3900 Main St Riverside, CA 92522	E-mail Address:		Telephone:	(951) 826-5311
Permit/Application Number(s):	THR23-012	Tract/Parcel Map Number(s):			
Additional Information/ Comments:					
Description of Project:	Proposed project consists of a new electric truck leasing service operation 4.09 acre (178,290 SF). Currently the site is a former car dealership. There is no building. Most of the site is now covered with asphalt in desrepair. Proposed project would consist of a building of approximately 2,660 SF, 155,615 SF of hardscape, and 22,675 SF of landscape. The impervious percentage is 87.28%. The site currently drains to the south. The project would maintain this natural drainage pattern. A total of seven catch basins leading to an underground chamber system is proposed.				
Provide summary of Conceptual WQMP conditions (if previously submitted and approved). Attach complete copy.					

Section 2 Project Description

2.1 Project Information

This section of the WQMP should provide the information listed below. The information provided for Conceptual/ Preliminary WQMP should give sufficient detail to identify the major proposed site design and LID BMPs and other anticipated water quality features that impact site planning. Final Project WQMP must specifically identify all BMP incorporated into the final site design and provide other detailed information as described herein.

The purpose of this information is to help determine the applicable development category, pollutants of concern, watershed description, and long term maintenance responsibilities for the project, and any applicable water quality credits. This information will be used in conjunction with the information in Section 3, Site Description, to establish the performance criteria and to select the LID BMP or other BMP for the project or other alternative programs that the project will participate in, which are described in Section 4.

Form 2.1-1 Description of Proposed Project					
1 Development Category (Select all that apply):					
<input checked="" type="checkbox"/> Significant re-development involving the addition or replacement of 5,000 ft ² or more of impervious surface on an already developed site	<input type="checkbox"/> New development involving the creation of 10,000 ft ² or more of impervious surface collectively over entire site	<input type="checkbox"/> Automotive repair shops with standard industrial classification (SIC) codes 5013, 5014, 5541, 7532- 7534, 7536-7539	<input type="checkbox"/> Restaurants (with SIC code 5812) where the land area of development is 5,000 ft ² or more		
<input type="checkbox"/> Hillside developments of 5,000 ft ² or more which are located on areas with known erosive soil conditions or where the natural slope is 25 percent or more	<input type="checkbox"/> Developments of 2,500 ft ² of impervious surface or more adjacent to (within 200 ft) or discharging directly into environmentally sensitive areas or waterbodies listed on the CWA Section 303(d) list of impaired waters.	<input checked="" type="checkbox"/> Parking lots of 5,000 ft ² or more exposed to storm water	<input type="checkbox"/> Retail gasoline outlets that are either 5,000 ft ² or more, or have a projected average daily traffic of 100 or more vehicles per day		
<input type="checkbox"/> Non-Priority / Non-Category Project <i>May require source control LID BMPs and other LIP requirements. Please consult with local jurisdiction on specific requirements.</i>					
2 Project Area (ft ²):	178,290	3 Number of Dwelling Units:	0	4 SIC Code:	4212
5 Is Project going to be phased? Yes <input type="checkbox"/> No <input checked="" type="checkbox"/> <i>If yes, ensure that the WQMP evaluates each phase as a distinct DA, requiring LID BMPs to address runoff at time of completion.</i>					
6 Does Project include roads? Yes <input type="checkbox"/> No <input checked="" type="checkbox"/> <i>If yes, ensure that applicable requirements for transportation projects are addressed (see Appendix A of TGD for WQMP)</i>					

2.2 Property Ownership/Management

Describe the ownership/management of all portions of the project and site. State whether any infrastructure will transfer to public agencies (City, County, Caltrans, etc.) after project completion. State if a homeowners or property owners association will be formed and be responsible for the long-term maintenance of project stormwater facilities. Describe any lot-level stormwater features that will be the responsibility of individual property owners.

Form 2.2-1 Property Ownership/Management

Describe property ownership/management responsible for long-term maintenance of WQMP stormwater facilities:

City of Riverside will be responsible for long-term maintenance of WQMP stormwater facilities.

City of Riverside
3900 Main Street
Riverside, CA 92522
(951) 826-5311

2.3 Potential Stormwater Pollutants

Determine and describe expected stormwater pollutants of concern based on land uses and site activities (refer to Table 3-3 in the TGD for WQMP).

Form 2.3-1 Pollutants of Concern			
Pollutant	Please check: E=Expected, N=Not Expected		Additional Information and Comments
	E <input checked="" type="checkbox"/>	N <input type="checkbox"/>	
Pathogens (Bacterial / Virus)	E <input checked="" type="checkbox"/>	N <input type="checkbox"/>	Per section 3.3 of the TGD for WQMP, potential sources include animal waste.
Phosphorous	E <input checked="" type="checkbox"/>	N <input type="checkbox"/>	Per section 3.3 of the TGD for WQMP, potential sources include fertilizers and eroded soils.
Nitrogen	E <input checked="" type="checkbox"/>	N <input type="checkbox"/>	Per section 3.3 of the TGD for WQMP, potential sources include fertilizers and eroded soils.
Sediment	E <input checked="" type="checkbox"/>	N <input type="checkbox"/>	Per section 3.3 of the TGD for WQMP, potential sources include eroded soils.
Metals	E <input checked="" type="checkbox"/>	N <input type="checkbox"/>	Per section 3.3 of the TGD for WQMP, potential sources include brake pad and tire tread wear associated with driving.
Oil and Grease	E <input checked="" type="checkbox"/>	N <input type="checkbox"/>	Per section 3.3 of the TGD for WQMP, potential sources include petroleum hydrocarbon products, motor products from leaking vehicles, esters, oils, fats, waxes, and high molecular-weight fatty acids.
Trash/Debris	E <input checked="" type="checkbox"/>	N <input type="checkbox"/>	Per section 3.3 of the TGD for WQMP, potential sources include paper, plastic, polystyrene packing foam, and aluminum materials.
Pesticides / Herbicides	E <input checked="" type="checkbox"/>	N <input type="checkbox"/>	Per section 3.3 of the TGD for WQMP, potential sources include fertilizers and pest sprays.
Organic Compounds	E <input checked="" type="checkbox"/>	N <input type="checkbox"/>	Per section 3.3 of the TGD for WQMP, potential sources include solvents and cleaning compounds.
Other:	E <input type="checkbox"/>	N <input type="checkbox"/>	
Other:	E <input type="checkbox"/>	N <input type="checkbox"/>	
Other:	E <input type="checkbox"/>	N <input type="checkbox"/>	
Other:	E <input type="checkbox"/>	N <input type="checkbox"/>	
Other:	E <input type="checkbox"/>	N <input type="checkbox"/>	
Other:	E <input type="checkbox"/>	N <input type="checkbox"/>	

2.4 Water Quality Credits

A water quality credit program is applicable for certain types of development projects if it is not feasible to meet the requirements for on-site LID. Proponents for eligible projects, as described below, can apply for water quality credits that would reduce project obligations for selecting and sizing other treatment BMP or participating in other alternative compliance programs. Refer to Section 6.2 in the TGD for WQMP to determine if water quality credits are applicable for the project.

Form 2.4-1 Water Quality Credits			
1 Project Types that Qualify for Water Quality Credits: <i>Select all that apply</i>			
<input type="checkbox"/> Redevelopment projects that reduce the overall impervious footprint of the project site. [Credit = % impervious reduced]	Higher density development projects <input type="checkbox"/> Vertical density [20%] <input type="checkbox"/> 7 units/ acre [5%]	<input type="checkbox"/> Mixed use development, (combination of residential, commercial, industrial, office, institutional, or other land uses which incorporate design principles that demonstrate environmental benefits not realized through single use projects) [20%]	<input type="checkbox"/> Brownfield redevelopment (redevelop real property complicated by presence or potential of hazardous contaminants) [25%]
<input type="checkbox"/> Redevelopment projects in established historic district, historic preservation area, or similar significant core city center areas [10%]	<input type="checkbox"/> Transit-oriented developments (mixed use residential or commercial area designed to maximize access to public transportation) [20%]	<input type="checkbox"/> In-fill projects (conversion of empty lots & other underused spaces < 5 acres, substantially surrounded by urban land uses, into more beneficially used spaces, such as residential or commercial areas) [10%]	<input type="checkbox"/> Live-Work developments (variety of developments designed to support residential and vocational needs) [20%]
2 Total Credit % 0 <i>(Total all credit percentages up to a maximum allowable credit of 50 percent)</i>			
Description of Water Quality Credit Eligibility (if applicable)	N/A		

Section 3 Site and Watershed Description

Describe the project site conditions that will facilitate the selection of BMP through an analysis of the physical conditions and limitations of the site and its receiving waters. Identify distinct drainage areas (DA) that collect flow from a portion of the site and describe how runoff from each DA (and sub-watershed DMAs) is conveyed to the site outlet(s). Refer to Section 3.2 in the TGD for WQMP. The form below is provided as an example. Then complete Forms 3.2 and 3.3 for each DA on the project site. ***If the project has more than one drainage area for stormwater management, then complete additional versions of these forms for each DA / outlet.***

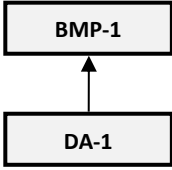
Form 3-1 Site Location and Hydrologic Features			
Site coordinates <i>take GPS measurement at approximate center of site</i>	Latitude 34.07553	Longitude -117.29470	Thomas Bros Map page 606
<p>¹ San Bernardino County climatic region: <input checked="" type="checkbox"/> Valley <input type="checkbox"/> Mountain</p>			
<p>² Does the site have more than one drainage area (DA): Yes <input type="checkbox"/> No <input checked="" type="checkbox"/> <i>If no, proceed to Form 3-2. If yes, then use this form to show a conceptual schematic describing DMAs and hydrologic feature connecting DMAs to the site outlet(s). An example is provided below that can be modified for proposed project or a drawing clearly showing DMA and flow routing may be attached</i></p>			
			
Conveyance	Briefly describe on-site drainage features to convey runoff that is not retained within a DMA		
DA-1 TO BMP-1	Drainage area drains to an underground infiltration system through catch basins. Overflow flows through parkway culvert located at south end of site along S. "E" Street.		

Form 3-2 Existing Hydrologic Characteristics for Drainage Area 1				
For Drainage Area 1's sub-watershed DMA, provide the following characteristics	DMA A (Asphalt)	DMA B (Building-Roof)	DMA C (Concrete)	DMA D (Pervious)
1 DMA drainage area (ft ²)	142,029	2,660	10,926	22,675
2 Existing site impervious area (ft ²)	124,176	124,176	124,176	124,176
3 Antecedent moisture condition <i>For desert areas, use http://www.sbcounty.gov/dpw/floodcontrol/pdf/20100412_map.pdf</i>	II	II	II	II
4 Hydrologic soil group <i>Refer to Watershed Mapping Tool – http://sbcounty.permitrack.com/WAP</i>	A	A	A	A
5 Longest flowpath length (ft)	704	0	274	718
6 Longest flowpath slope (ft/ft)	0.008	0.000	0.006	0.003
7 Current land cover type(s) <i>Select from Fig C-3 of Hydrology Manual</i>	Perennial Grasses	Perennial Grasses	Perennial Grasses	Perennial Grasses
8 Pre-developed pervious area condition: <i>Based on the extent of wet season vegetated cover good >75%; Fair 50-75%; Poor <50% Attach photos of site to support rating</i>	Poor	Poor	Poor	Poor

Form 3-3 Watershed Description for Drainage Area 1	
<p>Receiving waters Refer to Watershed Mapping Tool - http://sbcounty.permitrack.com/WAP See "Drainage Facilities" link at this website</p>	<p>Santa Ana River, Reach 5 Santa Ana River, Reach 4 Santa Ana River, Reach 3 Prado Reservoir Santa Ana River, Reach 2 Santa Ana River, Reach 1 Pacific Ocean</p>
<p>Applicable TMDLs Refer to Local Implementation Plan</p>	<p>Santa Ana River, Reach 4 - None Santa Ana River, Reach 3 - Pathogens, Nitrate Prado Reservoir - Pathogens Santa Ana River, Reach 2 - None Santa Ana River, Reach 1 - None Pacific Ocean - None</p>
<p>303(d) listed impairments Refer to Local Implementation Plan and Watershed Mapping Tool - http://sbcounty.permitrack.com/WAP and State Water Resources Control Board website - http://www.waterboards.ca.gov/santaana/water_issues/programs/tmdl/index.shtml</p>	<p>Santa Ana River, Reach 4 - Indicator Bacteria Santa Ana River, Reach 3 - Copper, Lead and Indicator Bacteria Prado Reservoir - pH</p>
<p>Environmentally Sensitive Areas (ESA) Refer to Watershed Mapping Tool - http://sbcounty.permitrack.com/WAP</p>	<p>Areas within 200': San Bernardino Kangaroo Rat</p>
<p>Unlined Downstream Water Bodies Refer to Watershed Mapping Tool - http://sbcounty.permitrack.com/WAP</p>	<p>None</p>
<p>Hydrologic Conditions of Concern</p>	<p><input type="checkbox"/> Yes Complete Hydrologic Conditions of Concern (HCOC) Assessment. Include Forms 4.2-2 through Form 4.2-5 and Hydromodification BMP Form 4.3-10 in submittal <input checked="" type="checkbox"/> No</p>
<p>Watershed-based BMP included in a RWQCB approved WAP</p>	<p><input type="checkbox"/> Yes Attach verification of regional BMP evaluation criteria in WAP • More Effective than On-site LID • Remaining Capacity for Project DCV • Upstream of any Water of the US • Operational at Project Completion • Long-Term Maintenance Plan <input checked="" type="checkbox"/> No</p>

Section 4 Best Management Practices (BMP)

4.1 Source Control BMP

4.1.1 Pollution Prevention

Non-structural and structural source control BMP are required to be incorporated into all new development and significant redevelopment projects. Form 4.1-1 and 4.1-2 are used to describe specific source control BMPs used in the WQMP or to explain why a certain BMP is not applicable. Table 7-3 of the TGD for WQMP provides a list of applicable source control BMP for projects with specific types of potential pollutant sources or activities. The source control BMP in this table must be implemented for projects with these specific types of potential pollutant sources or activities.

The preparers of this WQMP have reviewed the source control BMP requirements for new development and significant redevelopment projects. The preparers have also reviewed the specific BMP required for project as specified in Forms 4.1-1 and 4.1-2. All applicable non-structural and structural source control BMP shall be implemented in the project.

The information provided in Form 4.1.1 and 4.1.2 is based on section 7 of the TGD for WQMP (p.92-105) including table 7-3, CASQA BMP Handbooks and comments from the reviewing agency. The provided description of BMP implementation is a summary and not intended to be an all-inclusive list of actions. Refer to appendix 6.3 of the approved WQMP for applicable CASQA handouts and manufacturer information.

Water Quality Management Plan (WQMP)

Form 4.1-1 Non-Structural Source Control BMPs				
Identifier	Name	Check One		Describe BMP Implementation OR, if not applicable, state reason
		Included	Not Applicable	
N1	Education of Property Owners, Tenants and Occupants on Stormwater BMPs	<input checked="" type="checkbox"/>	<input type="checkbox"/>	The Property Owner will provide BMP educational information materials to any employees, tenants (if any), and occupants.
N2	Activity Restrictions	<input checked="" type="checkbox"/>	<input type="checkbox"/>	Activity restrictions will be imposed by the owner to limit exposure of stormwater to potential pollutants. Activity restrictions include posting "No Littering" signs and ensuring pesticide application is performed by a certified applicator.
N3	Landscape Management BMPs	<input checked="" type="checkbox"/>	<input type="checkbox"/>	Owner will ensure landscaping and irrigation is properly maintained. Fertilizers and pesticides be applied by certified persons.
N4	BMP Maintenance	<input checked="" type="checkbox"/>	<input type="checkbox"/>	The property owner will ensure regular inspection, repair, and maintenance of BMP.
N5	Title 22 CCR Compliance (How development will comply)	<input type="checkbox"/>	<input checked="" type="checkbox"/>	No hazardous waste storage is proposed for this project.
N6	Local Water Quality Ordinances	<input checked="" type="checkbox"/>	<input type="checkbox"/>	This project will comply with all local water quality ordinances through this WQMP.
N7	Spill Contingency Plan	<input type="checkbox"/>	<input checked="" type="checkbox"/>	Not applicable for proposed project.
N8	Underground Storage Tank Compliance	<input type="checkbox"/>	<input checked="" type="checkbox"/>	No underground storage tanks are proposed.
N9	Hazardous Materials Disclosure Compliance	<input type="checkbox"/>	<input checked="" type="checkbox"/>	No hazardous waste storage is proposed for this project.
N10	Uniform Fire Code Implementation	<input type="checkbox"/>	<input checked="" type="checkbox"/>	No hazardous waste storage is proposed for this project.

Water Quality Management Plan (WQMP)

Form 4.1-1 Non-Structural Source Control BMPs				
N11	Litter/Debris Control Program	<input checked="" type="checkbox"/>	<input type="checkbox"/>	Owner will ensure weekly inspection and clean up for litter and debris.
N12	Employee Training	<input checked="" type="checkbox"/>	<input type="checkbox"/>	Owner will ensure that employees are trained on BMPs.
N13	Housekeeping of Loading Docks	<input type="checkbox"/>	<input checked="" type="checkbox"/>	No proposed loading docks.
N14	Catch Basin Inspection Program	<input checked="" type="checkbox"/>	<input type="checkbox"/>	Owner will ensure catch basins are regularly inspected, repaired, and maintained.
N15	Vacuum Sweeping of Private Streets and Parking Lots	<input checked="" type="checkbox"/>	<input type="checkbox"/>	Parking areas shall be vacuummed and swepted monthly.
N16	Other Non-structural Measures for Public Agency Projects	<input type="checkbox"/>	<input checked="" type="checkbox"/>	Project is not a public agency project.
N17	Comply with all other applicable NPDES permits	<input checked="" type="checkbox"/>	<input type="checkbox"/>	The proposed site will comply with the construction general permit through implementation of the site specific Storm Water Pollution Prevention Plan (SWPPP).

Form 4.1-2 Structural Source Control BMPs

Identifier	Name	Check One		Describe BMP Implementation OR, If not applicable, state reason
		Included	Not Applicable	
S1	Provide storm drain system stencilling and signage (CASQA New Development BMP Handbook SD-13)	<input checked="" type="checkbox"/>	<input type="checkbox"/>	All storm drain inlets and catch basins will be labeled. Stenciled labels shall state "No Dumping – Drains to River" or similar message discouraging any litter dumping.
S2	Design and construct outdoor material storage areas to reduce pollution introduction (CASQA New Development BMP Handbook SD-34)	<input type="checkbox"/>	<input checked="" type="checkbox"/>	No outdoor material storage.
S3	Design and construct trash and waste storage areas to reduce pollution introduction (CASQA New Development BMP Handbook SD-32)	<input checked="" type="checkbox"/>	<input type="checkbox"/>	Trash storage areas will be designed in accordance with the City of San Bernardino.
S4	Use efficient irrigation systems & landscape design, water conservation, smart controllers, and source control (Statewide Model Landscape Ordinance; CASQA New Development BMP Handbook SD-12)	<input checked="" type="checkbox"/>	<input type="checkbox"/>	Owner will ensure landscaping and irrigation is properly maintained. Irrigation controls shall include rain-triggered shutoff devices to prevent irrigation after precipitation.
S5	Finish grade of landscaped areas at a minimum of 1-2 inches below top of curb, sidewalk, or pavement	<input checked="" type="checkbox"/>	<input type="checkbox"/>	Landscape areas will be a minimum of 1 inch below adjacent impervious areas.
S6	Protect slopes and channels and provide energy dissipation (CASQA New Development BMP Handbook SD-10)	<input type="checkbox"/>	<input checked="" type="checkbox"/>	Proposed site does not have slopes or channels.
S7	Covered dock areas (CASQA New Development BMP Handbook SD-31)	<input type="checkbox"/>	<input checked="" type="checkbox"/>	No dock areas are proposed.
S8	Covered maintenance bays with spill containment plans (CASQA New Development BMP Handbook SD-31)	<input type="checkbox"/>	<input checked="" type="checkbox"/>	No maintenance bays are proposed.
S9	Vehicle wash areas with spill containment plans (CASQA New Development BMP Handbook SD-33)	<input type="checkbox"/>	<input checked="" type="checkbox"/>	No vehicle washing is proposed.
S10	Covered outdoor processing areas (CASQA New Development BMP Handbook SD-36)	<input type="checkbox"/>	<input checked="" type="checkbox"/>	No outdoor processing proposed.

Water Quality Management Plan (WQMP)

Form 4.1-2 Structural Source Control BMPs

S11	Equipment wash areas with spill containment plans (CASQA New Development BMP Handbook SD-33)	<input type="checkbox"/>	<input checked="" type="checkbox"/>	No equipment washing proposed.
S12	Fueling areas (CASQA New Development BMP Handbook SD-30)	<input type="checkbox"/>	<input checked="" type="checkbox"/>	No fueling is proposed.
S13	Hillside landscaping (CASQA New Development BMP Handbook SD-10)	<input type="checkbox"/>	<input checked="" type="checkbox"/>	No hillside landscaping is proposed.
S14	Wash water control for food preparation areas	<input type="checkbox"/>	<input checked="" type="checkbox"/>	No food preparation proposed.
S15	Community car wash racks (CASQA New Development BMP Handbook SD-33)	<input type="checkbox"/>	<input checked="" type="checkbox"/>	No car washing proposed.

4.1.2 Preventative LID Site Design Practices

Site design practices associated with new LID requirements in the MS4 Permit should be considered in the earliest phases of a project. Preventative site design practices can result in smaller DCV for LID BMP and hydromodification control BMP by reducing runoff generation. Describe site design and drainage plan including:

- A narrative of site design practices utilized or rationale for not using practices
- A narrative of how site plan incorporates preventive site design practices
- Include an attached Site Plan layout which shows how preventative site design practices are included in WQMP

Refer to Section 5.2 of the TGD for WQMP for more details.

Form 4.1-3 Preventative LID Site Design Practices Checklist
<p>Site Design Practices <i>If yes, explain how preventative site design practice is addressed in project site plan. If no, other LID BMPs must be selected to meet targets</i></p>
<p>Minimize impervious areas: Yes <input checked="" type="checkbox"/> No <input type="checkbox"/> Explanation: Impervious area has been minimized as much as possible for the proposed use of this site. Proposed site is 87% impervious.</p>
<p>Maximize natural infiltration capacity: Yes <input checked="" type="checkbox"/> No <input type="checkbox"/> Explanation: Maximized natural infiltration capacity by incorporating a design that promotes water retention through placement of proposed landscape and infiltration BMPs.</p>
<p>Preserve existing drainage patterns and time of concentration: Yes <input checked="" type="checkbox"/> No <input type="checkbox"/> Explanation: Existing drainage patterns and time of concentration have been preserved as much as possible by avoiding channelization of natural drainage and retaining natural depressions of project area.</p>
<p>Disconnect impervious areas: Yes <input type="checkbox"/> No <input checked="" type="checkbox"/> Explanation: Impervious areas cannot be disconnected as the project needs driving surfaces for truck parking and electric vehicle charging stations.</p>
<p>Protect existing vegetation and sensitive areas: Yes <input type="checkbox"/> No <input checked="" type="checkbox"/> Explanation: Existing site will be entirely replaced with hardscape and landscaping. LID BMP selected to meet target is an underground infiltration system.</p>
<p>Re-vegetate disturbed areas: Yes <input checked="" type="checkbox"/> No <input type="checkbox"/> Explanation: Disturbed areas will be re-vegetated where possible.</p>
<p>Minimize unnecessary compaction in stormwater retention/infiltration basin/trench areas: Yes <input checked="" type="checkbox"/> No <input type="checkbox"/> Explanation: Stormwater BMP areas will be marked with flagging tape to minimize compaction and maximize natural infiltration capacity.</p>
<p>Utilize vegetated drainage swales in place of underground piping or imperviously lined swales: Yes <input type="checkbox"/> No <input checked="" type="checkbox"/> Explanation: Vegetated swales will not be used on this project. LID BMP selected to meet target is underground infiltration system.</p>
<p>Stake off areas that will be used for landscaping to minimize compaction during construction : Yes <input checked="" type="checkbox"/> No <input type="checkbox"/> Explanation: Landscape areas will be marked with flagging to minimize compaction and maximize natural infiltration capacity.</p>

4.2 Project Performance Criteria

The purpose of this section of the Project WQMP is to establish targets for post-development hydrology based on performance criteria specified in the MS4 Permit. These targets include runoff volume for water quality control (referred to as LID design capture volume), and runoff volume, time of concentration, and peak runoff for protection of any downstream waterbody segments with a HCOC. ***If the project has more than one outlet for stormwater runoff, then complete additional versions of these forms for each DA / outlet.***

Methods applied in the following forms include:

- For LID BMP Design Capture Volume (DCV), the San Bernardino County Stormwater Program requires use of the P₆ method (MS4 Permit Section XI.D.6a.ii) – Form 4.2-1
- For HCOC pre- and post-development hydrologic calculation, the San Bernardino County Stormwater Program requires the use of the Rational Method (San Bernardino County Hydrology Manual Section D). Forms 4.2-2 through Form 4.2-5 calculate hydrologic variables including runoff volume, time of concentration, and peak runoff from the project site pre- and post-development using the Hydrology Manual Rational Method approach. For projects greater than 640 acres (1.0 mi²), the Rational Method and these forms should not be used. For such projects, the Unit Hydrograph Method (San Bernardino County Hydrology Manual Section E) shall be applied for hydrologic calculations for HCOC performance criteria.

Refer to Section 4 in the TGD for WQMP for detailed guidance and instructions.

Form 4.2-1 LID BMP Performance Criteria for Design Capture Volume (DA 1)		
1 Project area DA 1 (ft ²): 178,290	2 Imperviousness after applying preventative site design practices (Imp%): 87.28	3 Runoff Coefficient (Rc): 0.692 $R_c = 0.858(Imp\%)^{0.3} - 0.78(Imp\%)^{0.2} + 0.774(Imp\%) + 0.04$
4 Determine 1-hour rainfall depth for a 2-year return period P _{2yr-1hr} (in): 0.495 http://hdsc.nws.noaa.gov/hdsc/pfds/so/sca_pfds.html		
5 Compute P ₆ , Mean 6-hr Precipitation (inches): 0.732 <i>P₆ = Item 4 * C₁, where C₁ is a function of site climatic region specified in Form 3-1 Item 1 (Valley = 1.4807; Mountain = 1.909; Desert = 1.2371)</i>		
6 Drawdown Rate <i>Use 48 hours as the default condition. Selection and use of the 24 hour drawdown time condition is subject to approval by the local jurisdiction. The necessary BMP footprint is a function of drawdown time. While shorter drawdown times reduce the performance criteria for LID BMP design capture volume, the depth of water that can be stored is also reduced.</i>		24-hrs <input type="checkbox"/> 48-hrs <input checked="" type="checkbox"/>
7 Compute design capture volume, DCV (ft ³): 14,788 $DCV = 1/12 * [Item\ 1 * Item\ 3 * Item\ 5 * C_2]$, where C ₂ is a function of drawdown rate (24-hr = 1.582; 48-hr = 1.963) <i>Compute separate DCV for each outlet from the project site per schematic drawn in Form 3-1 Item 2</i>		

Form 4.2-2 Summary of HCOC Assessment (DA 1)

Does project have the potential to cause or contribute to an HCOC in a downstream channel: Yes No

Go to: <http://sbcounty.permitrack.com/WAP>

If “Yes”, then complete HCOC assessment of site hydrology for 2yr storm event using Forms 4.2-3 through 4.2-5 and insert results below
(Forms 4.2-3 through 4.2-5 may be replaced by computer software analysis based on the San Bernardino County Hydrology Manual)

If “No,” then proceed to Section 4.3 Project Conformance Analysis

Condition	Runoff Volume (ft ³)	Time of Concentration (min)	Peak Runoff (cfs)
Pre-developed	1 <i>Form 4.2-3 Item 12</i>	2 <i>Form 4.2-4 Item 13</i>	3 <i>Form 4.2-5 Item 10</i>
Post-developed	4 <i>Form 4.2-3 Item 13</i>	5 <i>Form 4.2-4 Item 14</i>	6 <i>Form 4.2-5 Item 14</i>
Difference	7 <i>Item 4 – Item 1</i>	8 <i>Item 2– Item 5</i>	9 <i>Item 6 – Item 3</i>
Difference (as % of pre-developed)	10 % <i>Item 7 / Item 1</i>	11 % <i>Item 8 / Item 2</i>	12 % <i>Item 9 / Item 3</i>

Form 4.2-3 HCOC Assessment for Runoff Volume (DA 1)

Weighted Curve Number Determination for: Pre-developed DA	DMA A	DMA B	DMA C	DMA D	DMA E	DMA F	DMA G	DMA H
1a Land Cover type								
2a Hydrologic Soil Group (HSG)								
3a DMA Area, ft ² sum of areas of DMA should equal area of DA								
4a Curve Number (CN) use Items 1 and 2 to select the appropriate CN from Appendix C-2 of the TGD for WQMP								
Weighted Curve Number Determination for: Post-developed DA	DMA A	DMA B	DMA C	DMA D	DMA E	DMA F	DMA G	DMA H
1b Land Cover type								
2b Hydrologic Soil Group (HSG)								
3b DMA Area, ft ² sum of areas of DMA should equal area of DA								
4b Curve Number (CN) use Items 5 and 6 to select the appropriate CN from Appendix C-2 of the TGD for WQMP								
5 Pre-Developed area-weighted CN:	7 Pre-developed soil storage capacity, S (in): $S = (1000 / \text{Item } 5) - 10$				9 Initial abstraction, I _a (in): $I_a = 0.2 * \text{Item } 7$			
6 Post-Developed area-weighted CN:	8 Post-developed soil storage capacity, S (in): $S = (1000 / \text{Item } 6) - 10$				10 Initial abstraction, I _a (in): $I_a = 0.2 * \text{Item } 8$			
11 Precipitation for 2 yr, 24 hr storm (in): Go to: http://hdsc.nws.noaa.gov/hdsc/pfds/sa/sca_pfds.html								
12 Pre-developed Volume (ft ³): $V_{pre} = (1 / 12) * (\text{Item sum of Item } 3) * [(\text{Item } 11 - \text{Item } 9)^2 / ((\text{Item } 11 - \text{Item } 9 + \text{Item } 7))$								
13 Post-developed Volume (ft ³): $V_{pre} = (1 / 12) * (\text{Item sum of Item } 3) * [(\text{Item } 11 - \text{Item } 10)^2 / ((\text{Item } 11 - \text{Item } 10 + \text{Item } 8))$								
14 Volume Reduction needed to meet HCOC Requirement, (ft ³): $V_{HCOC} = (\text{Item } 13 * 0.95) - \text{Item } 12$								

Form 4.2-4 HCOC Assessment for Time of Concentration (DA 1)

Compute time of concentration for pre and post developed conditions for each DA (*For projects using the Hydrology Manual complete the form below*)

Variables	Pre-developed DA1 <i>Use additional forms if there are more than 4 DMA</i>				Post-developed DA1 <i>Use additional forms if there are more than 4 DMA</i>			
	DMA A	DMA B	DMA C	DMA D	DMA A	DMA B	DMA C	DMA D
1 Length of flowpath (ft) <i>Use Form 3-2 Item 5 for pre-developed condition</i>								
2 Change in elevation (ft)								
3 Slope (ft/ft), $S_o = \text{Item 2} / \text{Item 1}$								
4 Land cover								
5 Initial DMA Time of Concentration (min) <i>Appendix C-1 of the TGD for WQMP</i>								
6 Length of conveyance from DMA outlet to project site outlet (ft) <i>May be zero if DMA outlet is at project site outlet</i>								
7 Cross-sectional area of channel (ft ²)								
8 Wetted perimeter of channel (ft)								
9 Manning's roughness of channel (n)								
10 Channel flow velocity (ft/sec) $V_{fps} = (1.49 / \text{Item 9}) * (\text{Item 7}/\text{Item 8})^{0.67} * (\text{Item 3})^{0.5}$								
11 Travel time to outlet (min) $T_t = \text{Item 6} / (\text{Item 10} * 60)$								
12 Total time of concentration (min) $T_c = \text{Item 5} + \text{Item 11}$								
13 Pre-developed time of concentration (min):	<i>Minimum of Item 12 pre-developed DMA</i>							
14 Post-developed time of concentration (min):	<i>Minimum of Item 12 post-developed DMA</i>							
15 Additional time of concentration needed to meet HCOC requirement (min):	$T_{C-HCOC} = (\text{Item 14} * 0.95) - \text{Item 13}$							

Form 4.2-5 HCOC Assessment for Peak Runoff (DA 1)

Compute peak runoff for pre- and post-developed conditions						
Variables	Pre-developed DA to Project Outlet <i>(Use additional forms if more than 3 DMA)</i>			Post-developed DA to Project Outlet <i>(Use additional forms if more than 3 DMA)</i>		
	DMA A	DMA B	DMA C	DMA A	DMA B	DMA C
1 Rainfall Intensity for storm duration equal to time of concentration <i>$I_{peak} = 10^{(LOG Form 4.2-1 Item 4 - 0.6 LOG Form 4.2-4 Item 5 / 60)}$</i>						
2 Drainage Area of each DMA (ft ²) <i>For DMA with outlet at project site outlet, include upstream DMA (Using example schematic in Form 3-1, DMA A will include drainage from DMA C)</i>						
3 Ratio of pervious area to total area <i>For DMA with outlet at project site outlet, include upstream DMA (Using example schematic in Form 3-1, DMA A will include drainage from DMA C)</i>						
4 Pervious area infiltration rate (in/hr) <i>Use pervious area CN and antecedent moisture condition with Appendix C-3 of the TGD for WQMP</i>						
5 Maximum loss rate (in/hr) <i>$F_m = Item 3 * Item 4$ Use area-weighted F_m from DMA with outlet at project site outlet, include upstream DMA (Using example schematic in Form 3-1, DMA A will include drainage from DMA C)</i>						
6 Peak Flow from DMA (cfs) <i>$Q_p = Item 2 * 0.9 * (Item 1 - Item 5)$</i>						
7 Time of concentration adjustment factor for other DMA to site discharge point <i>Form 4.2-4 Item 12 DMA / Other DMA upstream of site discharge point (If ratio is greater than 1.0, then use maximum value of 1.0)</i>	DMA A	DMA B	DMA C	DMA A	DMA B	DMA C
	n/a	n/a	n/a	n/a	n/a	n/a
8 Pre-developed Q_p at T_c for DMA A: <i>$Q_p = Item 6_{DMAA} + [Item 6_{DMAB} * (Item 1_{DMAA} - Item 5_{DMAB}) / (Item 1_{DMAB} - Item 5_{DMAB}) * Item 7_{DMAA/2}] + [Item 6_{DMAC} * (Item 1_{DMAA} - Item 5_{DMAC}) / (Item 1_{DMAC} - Item 5_{DMAC}) * Item 7_{DMAA/3}]$</i>	9 Pre-developed Q_p at T_c for DMA B: <i>$Q_p = Item 6_{DMAB} + [Item 6_{DMAA} * (Item 1_{DMAB} - Item 5_{DMAA}) / (Item 1_{DMAA} - Item 5_{DMAA}) * Item 7_{DMAB/1}] + [Item 6_{DMAC} * (Item 1_{DMAB} - Item 5_{DMAC}) / (Item 1_{DMAC} - Item 5_{DMAC}) * Item 7_{DMAB/3}]$</i>		10 Pre-developed Q_p at T_c for DMA C: <i>$Q_p = Item 6_{DMAC} + [Item 6_{DMAA} * (Item 1_{DMAC} - Item 5_{DMAA}) / (Item 1_{DMAA} - Item 5_{DMAA}) * Item 7_{DMAC/1}] + [Item 6_{DMAB} * (Item 1_{DMAC} - Item 5_{DMAB}) / (Item 1_{DMAB} - Item 5_{DMAB}) * Item 7_{DMAC/2}]$</i>			
10 Peak runoff from pre-developed condition confluence analysis (cfs): <i>Maximum of Item 8, 9, and 10 (including additional forms as needed)</i>						
11 Post-developed Q_p at T_c for DMA A: <i>Same as Item 8 for post-developed values</i>	12 Post-developed Q_p at T_c for DMA B: <i>Same as Item 9 for post-developed values</i>		13 Post-developed Q_p at T_c for DMA C: <i>Same as Item 10 for post-developed values</i>			
14 Peak runoff from post-developed condition confluence analysis (cfs): <i>Maximum of Item 11, 12, and 13 (including additional forms as needed)</i>						
15 Peak runoff reduction needed to meet HCOC Requirement (cfs): <i>$Q_{p-HCOC} = (Item 14 * 0.95) - Item 10$</i>						

4.3 Project Conformance Analysis

Complete the following forms for each project site DA to document that the proposed LID BMPs conform to the project DCV developed to meet performance criteria specified in the MS₄ Permit (WQMP Template Section 4.2). For the LID DCV, the forms are ordered according to hierarchy of BMP selection as required by the MS₄ Permit (see Section 5.3.1 in the TGD for WQMP). The forms compute the following for on-site LID BMP:

- Site Design and Hydrologic Source Controls (Form 4.3-2)
- Retention and Infiltration (Form 4.3-3)
- Harvested and Use (Form 4.3-4) or
- Biotreatment (Form 4.3-5).

At the end of each form, additional fields facilitate the determination of the extent of mitigation provided by the specific BMP category, allowing for use of the next category of BMP in the hierarchy, if necessary.

The first step in the analysis, using Section 5.3.2.1 of the TGD for WQMP, is to complete Forms 4.3-1 and 4.3-3) to determine if retention and infiltration BMPs are infeasible for the project. For each feasibility criterion in Form 4.3-1, if the answer is “Yes,” provide all study findings that includes relevant calculations, maps, data sources, etc. used to make the determination of infeasibility.

Next, complete Forms 4.3-2 and 4.3-4 to determine the feasibility of applicable HSC and harvest and use BMPs, and, if their implementation is feasible, the extent of mitigation of the DCV.

If no site constraints exist that would limit the type of BMP to be implemented in a DA, evaluate the use of combinations of LID BMPs, including all applicable HSC BMPs to maximize on-site retention of the DCV. If no combination of BMP can mitigate the entire DCV, implement the single BMP type, or combination of BMP types, that maximizes on-site retention of the DCV within the minimum effective area.

If the combination of LID HSC, retention and infiltration, and harvest and use BMPs are unable to mitigate the entire DCV, then biotreatment BMPs may be implemented by the project proponent. If biotreatment BMPs are used, then they must be sized to provide sufficient capacity for effective treatment of the remainder of the volume-based performance criteria that cannot be achieved with LID BMPs (TGD for WQMP Section 5.4.4.2). **Under no circumstances shall any portion of the DCV be released from the site without effective mitigation and/or treatment.**

Form 4.3-1 Infiltration BMP Feasibility (DA 1)

Feasibility Criterion – Complete evaluation for each DA on the Project Site

1 Would infiltration BMP pose significant risk for groundwater related concerns? Yes No

Refer to Section 5.3.2.1 of the TGD for WQMP

If Yes, Provide basis: (attach)

2 Would installation of infiltration BMP significantly increase the risk of geotechnical hazards? Yes No

(Yes, if the answer to any of the following questions is yes, as established by a geotechnical expert):

- The location is less than 50 feet away from slopes steeper than 15 percent
- The location is less than eight feet from building foundations or an alternative setback.
- A study certified by a geotechnical professional or an available watershed study determines that stormwater infiltration would result in significantly increased risks of geotechnical hazards.

If Yes, Provide basis: (attach)

3 Would infiltration of runoff on a Project site violate downstream water rights? Yes No

If Yes, Provide basis: (attach)

4 Is proposed infiltration facility located on hydrologic soil group (HSG) D soils or does the site geotechnical investigation indicate presence of soil characteristics, which support categorization as D soils? Yes No

If Yes, Provide basis: (attach)

5 Is the design infiltration rate, after accounting for safety factor of 2.0, below proposed facility less than 0.3 in/hr (accounting for soil amendments)? Yes No

If Yes, Provide basis: (attach)

6 Would on-site infiltration or reduction of runoff over pre-developed conditions be partially or fully inconsistent with watershed management strategies as defined in the WAP, or impair beneficial uses? Yes No

See Section 3.5 of the TGD for WQMP and WAP

If Yes, Provide basis: (attach)

7 Any answer from Item 1 through Item 3 is "Yes": Yes No

If yes, infiltration of any volume is not feasible onsite. Proceed to Form 4.3-4, Harvest and Use BMP. If no, then proceed to Item 9 below.

8 Any answer from Item 4 through Item 6 is "Yes": Yes No

If yes, infiltration is permissible but is not required to be considered. Proceed to Form 4.3-2, Hydrologic Source Control BMP.

If no, then proceed to Item 9, below.

9 All answers to Item 1 through Item 6 are "No": Yes No

Infiltration of the full DCV is potentially feasible, LID infiltration BMP must be designed to infiltrate the full DCV to the MEP.

Proceed to Form 4.3-2, Hydrologic Source Control BMP.

4.3.1 Site Design Hydrologic Source Control BMP

Section XI.E. of the Permit emphasizes the use of LID preventative measures; and the use of LID HSC BMPs reduces the portion of the DCV that must be addressed in downstream BMPs. Therefore, all applicable HSC shall be provided except where they are mutually exclusive with each other, or with other BMPs. Mutual exclusivity may result from overlapping BMP footprints such that either would be potentially feasible by itself, but both could not be implemented. Please note that while there are no numeric standards regarding the use of HSC, if a project cannot feasibly meet BMP sizing requirements or cannot fully address HCOCs, feasibility of all applicable HSC must be part of demonstrating that the BMP system has been designed to retain the maximum feasible portion of the DCV. Complete Form 4.3-2 to identify and calculate estimated retention volume from implementing site design HSC BMP. Refer to Section 5.4.1 in the TGD for more detailed guidance.

Form 4.3-2 Site Design Hydrologic Source Control BMPs (DA 1)			
1 Implementation of Impervious Area Dispersion BMP (i.e. routing runoff from impervious to pervious areas), excluding impervious areas planned for routing to on-lot infiltration BMP: Yes <input type="checkbox"/> No <input checked="" type="checkbox"/> <i>If yes, complete Items 2-5; if no, proceed to Item 6</i>	DA DMA BMP Type	DA DMA BMP Type	DA DMA BMP Type <i>(Use additional forms for more BMPs)</i>
2 Total impervious area draining to pervious area (ft ²)			
3 Ratio of pervious area receiving runoff to impervious area			
4 Retention volume achieved from impervious area dispersion (ft ³) $V = \text{Item 2} * \text{Item 3} * (0.5/12)$, assuming retention of 0.5 inches of runoff	0	0	0
5 Sum of retention volume achieved from impervious area dispersion (ft ³): 0 $V_{\text{retention}} = \text{Sum of Item 4 for all BMPs}$			
6 Implementation of Localized On-lot Infiltration BMPs (e.g. on-lot rain gardens): Yes <input type="checkbox"/> No <input checked="" type="checkbox"/> <i>If yes, complete Items 7-13 for aggregate of all on-lot infiltration BMP in each DA; if no, proceed to Item 14</i>	DA DMA BMP Type	DA DMA BMP Type	DA DMA BMP Type <i>(Use additional forms for more BMPs)</i>
7 Ponding surface area (ft ²)			
8 Ponding depth (ft)			
9 Surface area of amended soil/gravel (ft ²)			
10 Average depth of amended soil/gravel (ft)			
11 Average porosity of amended soil/gravel			
12 Retention volume achieved from on-lot infiltration (ft ³) $V_{\text{retention}} = (\text{Item 7} * \text{Item 8}) + (\text{Item 9} * \text{Item 10} * \text{Item 11})$	0	0	0
13 Runoff volume retention from on-lot infiltration (ft ³): 0 $V_{\text{retention}} = \text{Sum of Item 12 for all BMPs}$			

Form 4.3-2 Site Design Hydrologic Source Control BMPs (DA 1)			
14 Implementation of evapotranspiration BMP (green, brown, or blue roofs): Yes <input type="checkbox"/> No <input checked="" type="checkbox"/> <i>If yes, complete Items 15-20. If no, proceed to Item 21</i>	DA DMA BMP Type	DA DMA BMP Type	DA DMA BMP Type (Use additional forms for more BMPs)
15 Rooftop area planned for ET BMP (ft ²)			
16 Average wet season ET demand (in/day) <i>Use local values, typical ~ 0.1</i>			
17 Daily ET demand (ft ³ /day) <i>Item 15 * (Item 16 / 12)</i>			
18 Drawdown time (hrs) <i>Copy Item 6 in Form 4.2-1</i>			
19 Retention Volume (ft ³) <i>V_{retention} = Item 17 * (Item 18 / 24)</i>	0	0	0
20 Runoff volume retention from evapotranspiration BMPs (ft ³): 0 <i>V_{retention} = Sum of Item 19 for all BMPs</i>			
21 Implementation of Street Trees: Yes <input type="checkbox"/> No <input checked="" type="checkbox"/> <i>If yes, complete Items 20-2. If no, proceed to Item 24</i>	DA DMA BMP Type	DA DMA BMP Type	DA DMA BMP Type (Use additional forms for more BMPs)
22 Number of Street Trees	0	0	0
23 Average canopy cover over impervious area (ft ²)			
24 Runoff volume retention from street trees (ft ³) <i>V_{retention} = Item 22 * Item 23 * (0.05/12) assume runoff retention of 0.05 inches</i>	0	0	0
25 Runoff volume retention from street tree BMPs (ft ³): 0 <i>V_{retention} = Sum of Item 24 for all BMPs</i>			
26 Implementation of residential rain barrels/cisterns: Yes <input type="checkbox"/> No <input checked="" type="checkbox"/> <i>If yes, complete Items 27-28; If no, proceed to Item 29</i>	DA DMA BMP Type	DA DMA BMP Type	DA DMA BMP Type (Use additional forms for more BMPs)
27 Number of rain barrels/cisterns	0	0	0
28 Runoff volume retention from rain barrels/cisterns (ft ³) <i>V_{retention} = Item 27 * 3</i>	0	0	0
29 Runoff volume retention from residential rain barrels/Cisterns (ft ³): 0 <i>V_{retention} = Sum of Item 28 for all BMPs</i>			
30 Total Retention Volume from Site Design Hydrologic Source Control BMPs: 0 <i>Sum of Items 5, 13, 20, 25 and 29</i>			

4.3.2 Infiltration BMPs

Use Form 4.3-3 to compute on-site retention of runoff from proposed retention and infiltration BMPs. Volume retention estimates are sensitive to the percolation rate used, which determines the amount of runoff that can be infiltrated within the specified drawdown time. The infiltration safety factor reduces field measured percolation to account for potential inaccuracy associated with field measurements, declining BMP performance over time, and compaction during construction. Appendix D of the TGD for WQMP provides guidance on estimating an appropriate safety factor to use in Form 4.3-3.

If site constraints limit the use of BMPs to a single type and implementation of retention and infiltration BMPs mitigate no more than 40% of the DCV, then they are considered infeasible and the Project Proponent may evaluate the effectiveness of BMPs lower in the LID hierarchy of use (Section 5.5.1 of the TGD for WQMP)

If implementation of infiltrations BMPs is feasible as determined using Form 4.3-1, then LID infiltration BMPs shall be implemented to the MEP (section 4.1 of the TGD for WQMP).

Form 4.3-3 Infiltration LID BMP - including underground BMPs (DA 1)

1 Remaining LID DCV not met by site design HSC BMP (ft ³): 14,788 $V_{unmet} = \text{Form 4.2-1 Item 7} - \text{Form 4.3-2 Item 30}$			
BMP Type Use columns to the right to compute runoff volume retention from proposed infiltration BMP (select BMP from Table 5-4 in TGD for WQMP) - Use additional forms for more BMPs	DA 1 DMA BMP Type Underground Infiltration	DA DMA BMP Type	DA DMA BMP Type (Use additional forms for more BMPs)
2 Infiltration rate of underlying soils (in/hr) See Section 5.4.2 and Appendix D of the TGD for WQMP for minimum requirements for assessment methods	7.10		
3 Infiltration safety factor See TGD Section 5.4.2 and Appendix D	2.81		
4 Design percolation rate (in/hr) $P_{design} = \text{Item 2} / \text{Item 3}$	2.52		
5 Pondered water drawdown time (hr) Copy Item 6 in Form 4.2-1	48		
6 Maximum ponding depth (ft) BMP specific, see Table 5-4 of the TGD for WQMP for BMP design details			
7 Ponding Depth (ft) $d_{BMP} = \text{Minimum of } (1/12 * \text{Item 4} * \text{Item 5}) \text{ or Item 6}$			
8 Infiltrating surface area, SA_{BMP} (ft ²) the lesser of the area needed for infiltration of full DCV or minimum space requirements from Table 5.7 of the TGD for WQMP			
9 Amended soil depth, d_{media} (ft) Only included in certain BMP types, see Table 5-4 in the TGD for WQMP for reference to BMP design details			
10 Amended soil porosity			
11 Gravel depth, d_{media} (ft) Only included in certain BMP types, see Table 5-4 of the TGD for WQMP for BMP design details			
12 Gravel porosity			
13 Duration of storm as basin is filling (hrs) Typical ~ 3hrs			
14 Above Ground Retention Volume (ft ³) $V_{retention} = \text{Item 8} * [\text{Item 7} + (\text{Item 9} * \text{Item 10}) + (\text{Item 11} * \text{Item 12}) + (\text{Item 13} * (\text{Item 4} / 12))]$			
15 Underground Retention Volume (ft ³) Volume determined using manufacturer's specifications and calculations	14,788		
16 Total Retention Volume from LID Infiltration BMPs: 14,788 (Sum of Items 14 and 15 for all infiltration BMP included in plan)			
17 Fraction of DCV achieved with infiltration BMP: 100% $\text{Retention}\% = \text{Item 16} / \text{Form 4.2-1 Item 7}$			
18 Is full LID DCV retained on-site with combination of hydrologic source control and LID retention and infiltration BMPs? Yes <input checked="" type="checkbox"/> No <input type="checkbox"/> If yes, demonstrate conformance using Form 4.3-10; If no, then reduce Item 3, Factor of Safety to 2.0 and increase Item 8, Infiltrating Surface Area, such that the portion of the site area used for retention and infiltration BMPs equals or exceeds the minimum effective area thresholds (Table 5-7 of the TGD for WQMP) for the applicable category of development and repeat all above calculations.			

4.3.3 Harvest and Use BMP

Harvest and use BMP may be considered if the full LID DCV cannot be met by maximizing infiltration BMPs. Use Form 4.3-4 to compute on-site retention of runoff from proposed harvest and use BMPs.

Volume retention estimates for harvest and use BMPs are sensitive to the on-site demand for captured stormwater. Since irrigation water demand is low in the wet season, when most rainfall events occur in San Bernardino County, the volume of water that can be used within a specified drawdown period is relatively low. The bottom portion of Form 4.3-4 facilitates the necessary computations to show infeasibility if a minimum incremental benefit of 40 percent of the LID DCV would not be achievable with MEP implementation of on-site harvest and use of stormwater (Section 5.5.4 of the TGD for WQMP).

Form 4.3-4 Harvest and Use BMPs (DA 1)			
1 Remaining LID DCV not met by site design HSC or infiltration BMP (ft ³): <i>V_{unmet} = Form 4.2-1 Item 7 - Form 4.3-2 Item 30 - Form 4.3-3 Item 16</i>			
BMP Type(s) <i>Compute runoff volume retention from proposed harvest and use BMP (Select BMPs from Table 5-4 of the TGD for WQMP) - Use additional forms for more BMPs</i>	DA BMP Type	DMA BMP Type	DA DMA BMP Type <i>(Use additional forms for more BMPs)</i>
2 Describe cistern or runoff detention facility			
3 Storage volume for proposed detention type (ft ³) <i>Volume of cistern</i>			
4 Landscaped area planned for use of harvested stormwater (ft ²)			
5 Average wet season daily irrigation demand (in/day) <i>Use local values, typical ~ 0.1 in/day</i>			
6 Daily water demand (ft ³ /day) <i>Item 4 * (Item 5 / 12)</i>			
7 Drawdown time (hrs) <i>Copy Item 6 from Form 4.2-1</i>			
8 Retention Volume (ft ³) <i>V_{retention} = Minimum of (Item 3) or (Item 6 * (Item 7 / 24))</i>			
9 Total Retention Volume (ft ³) from Harvest and Use BMP: <i>Sum of Item 8 for all harvest and use BMP included in plan</i>			
10 Is the full DCV retained with a combination of LID HSC, retention and infiltration, and harvest and use BMPs? Yes <input checked="" type="checkbox"/> No <input type="checkbox"/> <i>If yes, demonstrate conformance using Form 4.3-10. If no, then re-evaluate combinations of all LID BMP and optimize their implementation such that the maximum portion of the DCV is retained on-site (using a single BMP type or combination of BMP types). If the full DCV cannot be mitigated after this optimization process, proceed to Section 4.3.4.</i>			

4.3.4 Biotreatment BMP

Biotreatment BMPs may be considered if the full LID DCV cannot be met by maximizing retention and infiltration, and harvest and use BMPs. A key consideration when using biotreatment BMP is the effectiveness of the proposed BMP in addressing the pollutants of concern for the project (see Table 5-5 of the TGD for WQMP).

Use Form 4.3-5 to summarize the potential for volume based and/or flow based biotreatment options to biotreat the remaining unmet LID DCV w. Biotreatment computations are included as follows:

- Use Form 4.3-6 to compute biotreatment in small volume based biotreatment BMP (e.g. bioretention w/underdrains);
- Use Form 4.3-7 to compute biotreatment in large volume based biotreatment BMP (e.g. constructed wetlands);
- Use Form 4.3-8 to compute sizing criteria for flow-based biotreatment BMP (e.g. bioswales)

Form 4.3-5 Selection and Evaluation of Biotreatment BMP (DA 1)		
<p>1 Remaining LID DCV not met by site design HSC, infiltration, or harvest and use BMP for potential biotreatment (ft³): <i>Form 4.2-1 Item 7 - Form 4.3-2 Item 30 – Form 4.3-3 Item 16- Form 4.3-4 Item 9</i></p>	<p>List pollutants of concern <i>Copy from Form 2.3-1.</i></p>	
<p>2 Biotreatment BMP Selected <i>(Select biotreatment BMP(s) necessary to ensure all pollutants of concern are addressed through Unit Operations and Processes, described in Table 5-5 of the TGD for WQMP)</i></p>	<p style="text-align: center;">Volume-based biotreatment <i>Use Forms 4.3-6 and 4.3-7 to compute treated volume</i></p> <p><input type="checkbox"/> Bioretention with underdrain <input type="checkbox"/> Planter box with underdrain <input type="checkbox"/> Constructed wetlands <input type="checkbox"/> Wet extended detention <input type="checkbox"/> Dry extended detention</p>	<p style="text-align: center;">Flow-based biotreatment <i>Use Form 4.3-8 to compute treated volume</i></p> <p><input type="checkbox"/> Vegetated swale <input type="checkbox"/> Vegetated filter strip <input type="checkbox"/> Proprietary biotreatment</p>
<p>3 Volume biotreated in volume based biotreatment BMP (ft³): <i>Form 4.3-6 Item 15 + Form 4.3-7 Item 13</i></p>	<p>4 Compute remaining LID DCV with implementation of volume based biotreatment BMP (ft³): <i>Item 1 – Item 3</i></p>	<p>5 Remaining fraction of LID DCV for sizing flow based biotreatment BMP: % <i>Item 4 / Item 1</i></p>
<p>6 Flow-based biotreatment BMP capacity provided (cfs): <i>Use Figure 5-2 of the TGD for WQMP to determine flow capacity required to provide biotreatment of remaining percentage of unmet LID DCV (Item 5), for the project's precipitation zone (Form 3-1 Item 1)</i></p>		
<p>7 Metrics for MEP determination:</p> <ul style="list-style-type: none"> • Provided a WQMP with the portion of site area used for suite of LID BMP equal to minimum thresholds in Table 5-7 of the TGD for WQMP for the proposed category of development: <input type="checkbox"/> <i>If maximized on-site retention BMPs is feasible for partial capture, then LID BMP implementation must be optimized to retain and infiltrate the maximum portion of the DCV possible within the prescribed minimum effective area. The remaining portion of the DCV shall then be mitigated using biotreatment BMP.</i> 		

Form 4.3-6 Volume Based Biotreatment (DA 1) – Bioretention and Planter Boxes with Underdrains

Biotreatment BMP Type <i>(Bioretention w/underdrain, planter box w/underdrain, other comparable BMP)</i>	DA BMP Type	DMA BMP Type	DA DMA BMP Type <i>(Use additional forms for more BMPs)</i>
1 Pollutants addressed with BMP <i>List all pollutant of concern that will be effectively reduced through specific Unit Operations and Processes described in Table 5-5 of the TGD for WQMP</i>			
2 Amended soil infiltration rate <i>Typical ~ 5.0</i>			
3 Amended soil infiltration safety factor <i>Typical ~ 2.0</i>			
4 Amended soil design percolation rate (in/hr) $P_{design} = \text{Item 2} / \text{Item 3}$			
5 Pondered water drawdown time (hr) <i>Copy Item 6 from Form 4.2-1</i>			
6 Maximum ponding depth (ft) <i>see Table 5-6 of the TGD for WQMP for reference to BMP design details</i>			
7 Ponding Depth (ft) $d_{BMP} = \text{Minimum of } (1/12 * \text{Item 4} * \text{Item 5}) \text{ or Item 6}$			
8 Amended soil surface area (ft ²)			
9 Amended soil depth (ft) <i>see Table 5-6 of the TGD for WQMP for reference to BMP design details</i>			
10 Amended soil porosity, <i>n</i>			
11 Gravel depth (ft) <i>see Table 5-6 of the TGD for WQMP for reference to BMP design details</i>			
12 Gravel porosity, <i>n</i>			
13 Duration of storm as basin is filling (hrs) <i>Typical ~ 3hrs</i>			
14 Biotreated Volume (ft ³) $V_{biotreated} = \text{Item 8} * [(\text{Item 7}/2) + (\text{Item 9} * \text{Item 10}) + (\text{Item 11} * \text{Item 12}) + (\text{Item 13} * (\text{Item 4} / 12))]$			
15 Total biotreated volume from bioretention and/or planter box with underdrains BMP: <i>Sum of Item 14 for all volume-based BMPs included in this form</i>			

Form 4.3-7 Volume Based Biotreatment (DA 1) – Constructed Wetlands and Extended Detention

Biotreatment BMP Type <i>Constructed wetlands, extended wet detention, extended dry detention, or other comparable proprietary BMP. If BMP includes multiple modules (e.g. forebay and main basin), provide separate estimates for storage and pollutants treated in each module.</i>	DA DMA BMP Type		DA DMA BMP Type <i>(Use additional forms for more BMPs)</i>	
	Forebay	Basin	Forebay	Basin
1 Pollutants addressed with BMP forebay and basin <i>List all pollutant of concern that will be effectively reduced through specific Unit Operations and Processes described in Table 5-5 of the TGD for WQMP</i>				
2 Bottom width (ft)				
3 Bottom length (ft)				
4 Bottom area (ft ²) $A_{bottom} = \text{Item 2} * \text{Item 3}$				
5 Side slope (ft/ft)				
6 Depth of storage (ft)				
7 Water surface area (ft ²) $A_{surface} = (\text{Item 2} + (2 * \text{Item 5} * \text{Item 6})) * (\text{Item 3} + (2 * \text{Item 5} * \text{Item 6}))$				
8 Storage volume (ft ³) <i>For BMP with a forebay, ensure fraction of total storage is within ranges specified in BMP specific fact sheets, see Table 5-6 of the TGD for WQMP for reference to BMP design details</i> $V = \text{Item 6} / 3 * [\text{Item 4} + \text{Item 7} + (\text{Item 4} * \text{Item 7})^{0.5}]$				
9 Drawdown Time (hrs) <i>Copy Item 6 from Form 2.1</i>				
10 Outflow rate (cfs) $Q_{BMP} = (\text{Item 8}_{forebay} + \text{Item 8}_{basin}) / (\text{Item 9} * 3600)$				
11 Duration of design storm event (hrs)				
12 Biotreated Volume (ft ³) $V_{biotreated} = (\text{Item 8}_{forebay} + \text{Item 8}_{basin}) + (\text{Item 10} * \text{Item 11} * 3600)$				
13 Total biotreated volume from constructed wetlands, extended dry detention, or extended wet detention : <i>(Sum of Item 12 for all BMP included in plan)</i>				

Form 4.3-8 Flow Based Biotreatment (DA 1)			
Biotreatment BMP Type <i>Vegetated swale, vegetated filter strip, or other comparable proprietary BMP</i>	DA DMA BMP Type	DA DMA BMP Type	DA DMA BMP Type <i>(Use additional forms for more BMPs)</i>
1 Pollutants addressed with BMP <i>List all pollutant of concern that will be effectively reduced through specific Unit Operations and Processes described in TGD Table 5-5</i>			
2 Flow depth for water quality treatment (ft) <i>BMP specific, see Table 5-6 of the TGD for WQMP for reference to BMP design details</i>			
3 Bed slope (ft/ft) <i>BMP specific, see Table 5-6 of the TGD for WQMP for reference to BMP design details</i>			
4 Manning's roughness coefficient			
5 Bottom width (ft) $b_w = (\text{Form 4.3-5 Item 6} * \text{Item 4}) / (1.49 * \text{Item 2}^{1.67} * \text{Item 3}^{0.5})$			
6 Side Slope (ft/ft) <i>BMP specific, see Table 5-6 of the TGD for WQMP for reference to BMP design details</i>			
7 Cross sectional area (ft ²) $A = (\text{Item 5} * \text{Item 2}) + (\text{Item 6} * \text{Item 2}^{0.2})$			
8 Water quality flow velocity (ft/sec) $V = \text{Form 4.3-5 Item 6} / \text{Item 7}$			
9 Hydraulic residence time (min) <i>Pollutant specific, see Table 5-6 of the TGD for WQMP for reference to BMP design details</i>			
10 Length of flow based BMP (ft) $L = \text{Item 8} * \text{Item 9} * 60$			
11 Water surface area at water quality flow depth (ft ²) $SA_{top} = (\text{Item 5} + (2 * \text{Item 2} * \text{Item 6})) * \text{Item 10}$			

4.3.5 Conformance Summary

Complete Form 4.3-9 to demonstrate how on-site LID DCV is met with proposed site design hydrologic source control, infiltration, harvest and use, and/or biotreatment BMP. The bottom line of the form is used to describe the basis for infeasibility determination for on-site LID BMP to achieve full LID DCV, and provides methods for computing remaining volume to be addressed in an alternative compliance plan. If the project has more than one outlet, then complete additional versions of this form for each outlet.

Form 4.3-9 Conformance Summary and Alternative Compliance Volume Estimate (DA 1)	
1	Total LID DCV for the Project DA-1 (ft ³): 14,788 <i>Copy Item 7 in Form 4.2-1</i>
2	On-site retention with site design hydrologic source control LID BMP (ft ³): 0 <i>Copy Item 30 in Form 4.3-2</i>
3	On-site retention with LID infiltration BMP (ft ³): 14,788 <i>Copy Item 16 in Form 4.3-3</i>
4	On-site retention with LID harvest and use BMP (ft ³): 0 <i>Copy Item 9 in Form 4.3-4</i>
5	On-site biotreatment with volume based biotreatment BMP (ft ³): 0 <i>Copy Item 3 in Form 4.3-5</i>
6	Flow capacity provided by flow based biotreatment BMP (cfs): <i>Copy Item 6 in Form 4.3-5</i>
7 LID BMP performance criteria are achieved if answer to any of the following is "Yes":	
<ul style="list-style-type: none"> • Full retention of LID DCV with site design HSC, infiltration, or harvest and use BMP: Yes <input checked="" type="checkbox"/> No <input type="checkbox"/> <i>If yes, sum of Items 2, 3, and 4 is greater than Item 1</i> • Combination of on-site retention BMPs for a portion of the LID DCV and volume-based biotreatment BMP that address all pollutants of concern for the remaining LID DCV: Yes <input type="checkbox"/> No <input type="checkbox"/> <i>If yes, a) sum of Items 2, 3, 4, and 5 is greater than Item 1, and Items 2, 3 and 4 are maximized; or b) Item 6 is greater than Form 4.3--5 Item 6 and Items 2, 3 and 4 are maximized</i> ▪ On-site retention and infiltration is determined to be infeasible and biotreatment BMP provide biotreatment for all pollutants of concern for full LID DCV: Yes <input type="checkbox"/> No <input type="checkbox"/> <i>If yes, Form 4.3-1 Items 7 and 8 were both checked yes</i> 	
8 If the LID DCV is not achieved by any of these means, then the project may be allowed to develop an alternative compliance plan. Check box that describes the scenario which caused the need for alternative compliance:	
<ul style="list-style-type: none"> • Combination of HSC, retention and infiltration, harvest and use, and biotreatment BMPs provide less than full LID DCV capture: <input type="checkbox"/> <i>Checked yes for Form 4.3-5 Item 7, Item 6 is zero, and sum of Items 2, 3, 4, and 5 is less than Item 1. If so, apply water quality credits and calculate volume for alternative compliance, $V_{alt} = (Item\ 1 - Item\ 2 - Item\ 3 - Item\ 4 - Item\ 5) * (100 - Form\ 2.4-1\ Item\ 2)\%$</i> • An approved Watershed Action Plan (WAP) demonstrates that water quality and hydrologic impacts of urbanization are more effective when managed in at an off-site facility: <input type="checkbox"/> <i>Attach appropriate WAP section, including technical documentation, showing effectiveness comparisons for the project site and regional watershed</i> 	

4.3.6 Hydromodification Control BMP

Use Form 4.3-10 to compute the remaining runoff volume retention, after LID BMP are implemented, needed to address HCOC, and the increase in time of concentration and decrease in peak runoff necessary to meet targets for protection of waterbodies with a potential HCOC. Describe hydromodification control BMP that address HCOC, which may include off-site BMP and/or in-stream controls. Section 5.6 of the TGD for WQMP provides additional details on selection and evaluation of hydromodification control BMP.

Form 4.3-10 Hydromodification Control BMPs (DA 1)	
<p>1 Volume reduction needed for HCOC performance criteria (ft³): <i>(Form 4.2-2 Item 4 * 0.95) – Form 4.2-2 Item 1</i></p>	<p>2 On-site retention with site design hydrologic source control, infiltration, and harvest and use LID BMP (ft³): <i>Sum of Form 4.3-9 Items 2, 3, and 4 Evaluate option to increase implementation of on-site retention in Forms 4.3-2, 4.3-3, and 4.3-4 in excess of LID DCV toward achieving HCOC volume reduction</i></p>
<p>3 Remaining volume for HCOC volume capture (ft³): <i>Item 1 – Item 2</i></p>	<p>4 Volume capture provided by incorporating additional on-site or off-site retention BMPs (ft³): <i>Existing downstream BMP may be used to demonstrate additional volume capture (if so, attach to this WQMP a hydrologic analysis showing how the additional volume would be retained during a 2-yr storm event for the regional watershed)</i></p>
<p>5 If Item 4 is less than Item 3, incorporate in-stream controls on downstream waterbody segment to prevent impacts due to hydromodification <input type="checkbox"/> <i>Attach in-stream control BMP selection and evaluation to this WQMP</i></p>	
<p>6 Is Form 4.2-2 Item 11 less than or equal to 5%: Yes <input type="checkbox"/> No <input type="checkbox"/> <i>If yes, HCOC performance criteria is achieved. If no, select one or more mitigation options below:</i></p> <ul style="list-style-type: none"> • Demonstrate increase in time of concentration achieved by proposed LID site design, LID BMP, and additional on-site or off-site retention BMP <input type="checkbox"/> <i>BMP upstream of a waterbody segment with a potential HCOC may be used to demonstrate increased time of concentration through hydrograph attenuation (if so, show that the hydraulic residence time provided in BMP for a 2-year storm event is equal or greater than the addition time of concentration requirement in Form 4.2-4 Item 15)</i> • Increase time of concentration by preserving pre-developed flow path and/or increase travel time by reducing slope and increasing cross-sectional area and roughness for proposed on-site conveyance facilities <input type="checkbox"/> • Incorporate appropriate in-stream controls for downstream waterbody segment to prevent impacts due to hydromodification, in a plan approved and signed by a licensed engineer in the State of California <input type="checkbox"/> 	
<p>7 Form 4.2-2 Item 12 less than or equal to 5%: Yes <input type="checkbox"/> No <input type="checkbox"/> <i>If yes, HCOC performance criteria is achieved. If no, select one or more mitigation options below:</i></p> <ul style="list-style-type: none"> • Demonstrate reduction in peak runoff achieved by proposed LID site design, LID BMPs, and additional on-site or off-site retention BMPs <input type="checkbox"/> <i>BMPs upstream of a waterbody segment with a potential HCOC may be used to demonstrate additional peak runoff reduction through hydrograph attenuation (if so, attach to this WQMP, a hydrograph analysis showing how the peak runoff would be reduced during a 2-yr storm event)</i> • Incorporate appropriate in-stream controls for downstream waterbody segment to prevent impacts due to hydromodification, in a plan approved and signed by a licensed engineer in the State of California <input type="checkbox"/> 	

4.4 Alternative Compliance Plan (if applicable)

Describe an alternative compliance plan (if applicable) for projects not fully able to infiltrate, harvest and use, or biotreat the DCV via on-site LID practices. A project proponent must develop an alternative compliance plan to address the remainder of the LID DCV. Depending on project type some projects may qualify for water quality credits that can be applied to reduce the DCV that must be treated prior to development of an alternative compliance plan (see Form 2.4-1, Water Quality Credits). Form 4.3-9 Item 8 includes instructions on how to apply water quality credits when computing the DCV that must be met through alternative compliance. Alternative compliance plans may include one or more of the following elements:

- On-site structural treatment control BMP - All treatment control BMP should be located as close to possible to the pollutant sources and should not be located within receiving waters;
- Off-site structural treatment control BMP - Pollutant removal should occur prior to discharge of runoff to receiving waters;
- Urban runoff fund or In-lieu program, if available

Depending upon the proposed alternative compliance plan, approval by the executive officer may or may not be required (see Section 6 of the TGD for WQMP).

Section 5 Inspection and Maintenance Responsibility for Post Construction BMP

All BMP included as part of the project WQMP are required to be maintained through regular scheduled inspection and maintenance (refer to Section 8, Post Construction BMP Requirements, in the TGD for WQMP). Fully complete Form 5-1 summarizing all BMP included in the WQMP. Attach additional forms as needed. The WQMP shall also include a detailed Operation and Maintenance Plan for all BMP and may require a Maintenance Agreement (consult the jurisdiction's LIP). See CASQA and manufacturer handouts in O&M plan for more detailed BMP maintenance information. If a Maintenance Agreement is required, it must also be attached to the WQMP.

Form 5-1 BMP Inspection and Maintenance (use additional forms as necessary)			
BMP	Responsible Party(s)	Inspection/Maintenance Activities Required	Minimum Frequency of Activities
Underground Chambers	Property Owner	Inspect for trash and debris. Clean up trash and debris if needed.	Monthly
		Inspect for sediment and damage. Clean and repair per manufacturer's recommendations.	Annually prior to October 1st and after major storm events
		These maintenance activities have been derived the manufacturer handouts, which is provided in appendix B of the O&M plan.	
Education of Property Owners, Tenants & Occupants on Stormwater BMPs	Property Owner	The Property Owner will provide BMP educational information materials to all employees and occupants of site.	Within 3 months of hire and annually thereafter
Activity Restrictions	Property Owner	Inspect for "No Littering" signs to prevent pollution to stormwater BMP. Inspect to ensure only certified persons apply fertilizer and pesticide.	Daily
Landscape Management BMPs	Property Owner	Owner will ensure landscaping and irrigation is properly maintained. Fertilizers and pesticides be applied by certified persons.	Weekly
BMP Maintenance	Property Owner	Inspect, clean, repair and maintain BMP.	Monthly

Water Quality Management Plan (WQMP)

Local Water Quality Ordinances	Property Owner	Local water quality ordinances shall be followed per local agency.	As needed
Litter/Debris Control Program	Property Owner	Inspect and clean site for trash and debris	Weekly
Employee Training	Property Owner	Educational materials on general housekeeping practices for the protection of storm water quality shall be provided to employees.	Within 3 months of hire and annually thereafter
Catch Basin Inserts	Property Owner	Inspect for trash, debris and damage	Monthly
Vacuum Sweeping	Property Owner	Parking lots shall be swept and vacuumed	Monthly
NPDES Permits	Property Owner	Approval and implementation of this WQMP and SWPPP.	On going
Provide storm drain system stenciling and signage	Property Owner	Inspected storm drain system stenciling and signage for clarity and legibility. Relabel as needed.	Annually, repair as needed
Trash Storage Area	Property Owner	Inspect, clean, and repair as needed.	As needed
Use Efficient Irrigation System and Landscape Design	Property Owner	Install irrigation systems with timing devices to avoid overwatering. Repair as needed	Weekly
Finish grade of landscaped areas at a minimum of 1-2 inches below top of curb, sidewalk, or pavement	Property Owner	Landscape areas will be a minimum of 1 inch below adjacent impervious areas.	Once

Section 6 WQMP Attachments

6.1. Site Plan and Drainage Plan

Include a site plan and drainage plan sheet set containing the following minimum information:

- Project location
- Site boundary
- Land uses and land covers, as applicable
- Suitability/feasibility constraints
- Structural Source Control BMP locations
- Site Design Hydrologic Source Control BMP locations
- LID BMP details
- Drainage delineations and flow information
- Drainage connections

6.2 Electronic Data Submittal

Minimum requirements include submittal of PDF exhibits in addition to hard copies. Format must not require specialized software to open. If the local jurisdiction requires specialized electronic document formats (as described in their local Local Implementation Plan), this section will describe the contents (e.g., layering, nomenclature, geo-referencing, etc.) of these documents so that they may be interpreted efficiently and accurately.

6.3 Post Construction

Attach all O&M Plans and Maintenance Agreements for BMP to the WQMP.

- O&M Plan
 - BMP Educational Materials
- Maintenance Agreement(s)
- Activity Restriction – C, C&R's & Lease Agreements

6.4 Other Supporting Documentation

- San Bernardino County Watershed Mapping Tool Data
- NOAA Rainfall Data
- Soils information

Appendix 6.1 – Site Plan and Drainage Plan

PROPOSED PROJECT IMPROVEMENTS:

- 1 BUILDING
- 2 LANDSCAPING
- 3 ASPHALT PARKING
- 4 24"x24" CATCH BASIN, SEE DETAIL BOTTOM RIGHT.
- 5 UNDERGROUND CHAMBER SYSTEM, SEE DETAIL BELOW, AND FULL-SIZED IN SECTION 6.4.
- 6 PARKWAY CULVERT

PROPOSED SITE DESIGN BMP'S:

- 1 SITE DESIGN & LANDSCAPE PLANNING (SD-10)
- 1 ROOF RUNOFF CONTROLS (SD-11)
- 2 EFFICIENT IRRIGATION (SD-12)
- 3 STORM DRAIN SIGNAGE (SD-13)
- 4 TRASH STORAGE AREAS (SD-32)

PROPOSED SOURCE CONTROL BMP'S:

- 1 SPILL PREVENTION, CONTROL & CLEANUP (SC-11)
- 2 WASTE HANDLING & DISPOSAL (SC-34)
- 3 BUILDING & GROUNDS MAINTENANCE (SC-41)
- 4 PARKING & STORAGE AREA MAINTENANCE (SC-43)
- 5 DRAINAGE SYSTEM MAINTENANCE (SC-44)

PROPOSED TREATMENT CONTROL BMP'S:

- 1 UNDERGROUND INFILTRATION SYSTEM
- 2 DRAIN INSERT (MP-52)

VICINITY MAP
N.T.S.

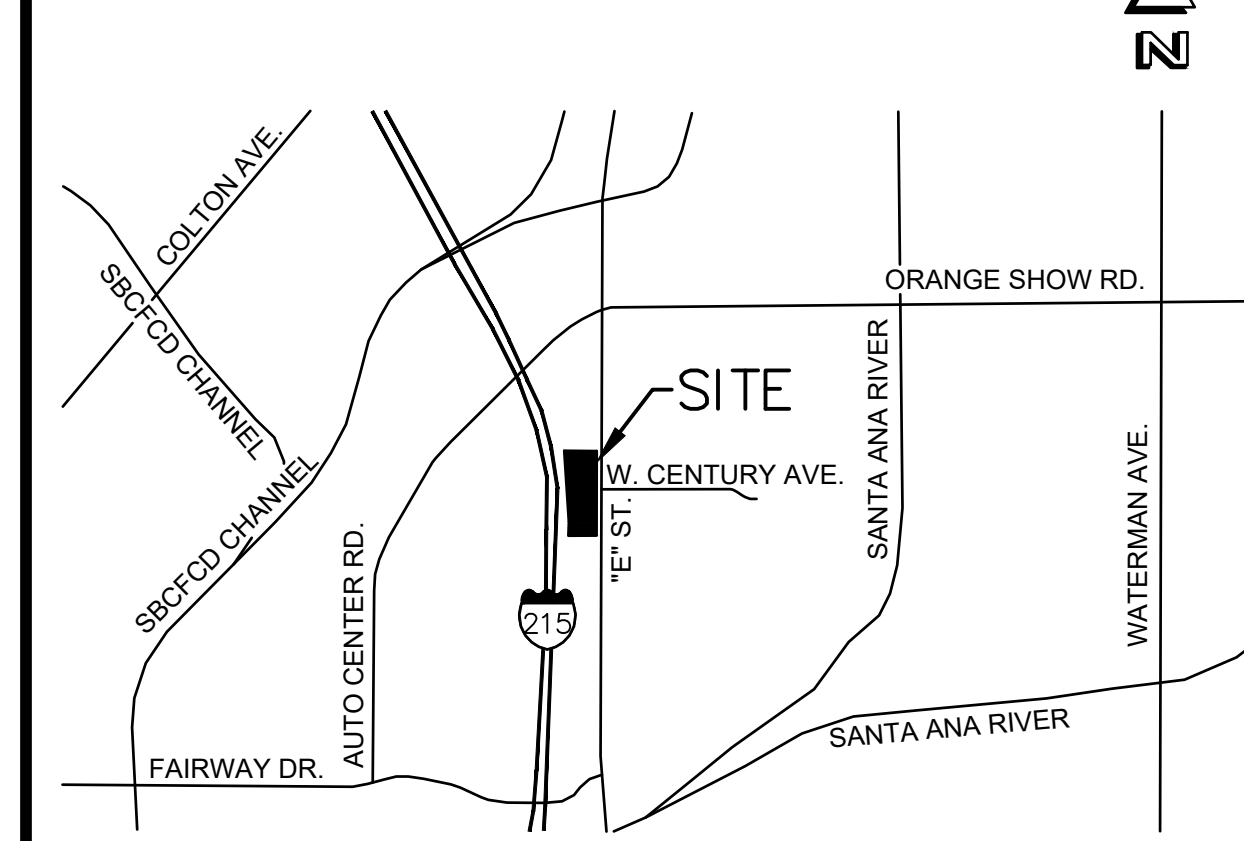

CITY OF SAN BERNARDINO, CA

OWNER INFORMATION:

CITY OF RIVERSIDE
3900 MAIN STREET
RIVERSIDE, CA 92522
TEL. (951) 826-5311

DA-1 COVER INFORMATION:

COVER TYPE	QTY
ASPHALT (DMA A):	142,029 SF.
BUILDING (DMA B):	2,660 SF.
CONCRETE (DMA C):	10,926 SF.
LANDSCAPING (DMA D):	22,675 SF.
TOTAL:	178,290

LEGEND:

- W.Q.M.P. DRAINAGE AREA
- PROPERTY LIMITS
- FLOW LINE
- PROPOSED LANDSCAPING AREAS
- PROPOSED CONCRETE PAVING AREAS
- PROPOSED A/C PAVING AREAS
- PROPOSED STRUCTURES

W.Q.M.P. NOTES:

- STRUCTURAL BMP'S MAY BE SUBSTITUTED FOR EQUIVALENT PRODUCTS WITH WRITTEN APPROVAL FROM THE ENGINEER OF RECORD AND COUNTY, BASED ON AVAILABILITY AT TIME OF CONSTRUCTION.
- TREATMENT CONTROL BMP'S MAY BE SUBSTITUTED FOR EQUIVALENT PRODUCTS WITH WRITTEN APPROVAL FROM THE ENGINEER OF RECORD AND COUNTY.
- THIS WQMP EXHIBIT SHALL NOT BE USED FOR CONSTRUCTION. SEE APPROVED GRADING PLANS FOR CONSTRUCTION DETAILS AND CROSS-SECTIONS.

FLEXSTORM PURE FILTERS FOR PERMANENT INLET PROTECTION
PRODUCT SELECTION AND SPECIFICATION DRAWING

Standard	Inlet Type	Grade Size	Flow Capacity (CF)	Flow Rating (F)	Flow Rating (G)	Flow Rating (H)	Flow Rating (I)	Flow Rating (J)	Flow Rating (K)	Flow Rating (L)	Flow Rating (M)	Flow Rating (N)	Flow Rating (O)	Flow Rating (P)	Flow Rating (Q)	Flow Rating (R)	Flow Rating (S)	Flow Rating (T)	Flow Rating (U)	Flow Rating (V)	Flow Rating (W)	Flow Rating (X)	Flow Rating (Y)	Flow Rating (Z)
36" Open Throat Inlet	Open Throat (MM)	N/A	36	2.5	1.9	1.4	N/A	S2H0M02FX	S2H0M02FX	S2H0M02FX	S2H0M02FX	S2H0M02FX	S2H0M02FX	S2H0M02FX	S2H0M02FX	S2H0M02FX	S2H0M02FX	S2H0M02FX	S2H0M02FX	S2H0M02FX	S2H0M02FX	S2H0M02FX	S2H0M02FX	S2H0M02FX
42" Open Throat Inlet	Open Throat (MM)	N/A	42	3.0	2.5	1.7	N/A	S2H0M04FX	S2H0M04FX	S2H0M04FX	S2H0M04FX	S2H0M04FX	S2H0M04FX	S2H0M04FX	S2H0M04FX	S2H0M04FX	S2H0M04FX	S2H0M04FX	S2H0M04FX	S2H0M04FX	S2H0M04FX	S2H0M04FX	S2H0M04FX	S2H0M04FX
48" Open Throat Inlet	Open Throat (MM)	N/A	48	3.3	2.5	1.7	N/A	S2H0M06FX	S2H0M06FX	S2H0M06FX	S2H0M06FX	S2H0M06FX	S2H0M06FX	S2H0M06FX	S2H0M06FX	S2H0M06FX	S2H0M06FX	S2H0M06FX	S2H0M06FX	S2H0M06FX	S2H0M06FX	S2H0M06FX	S2H0M06FX	S2H0M06FX
60" Open Throat Inlet	Open Throat (MM)	N/A	60	4.2	2.5	1.7	N/A	S2H0M08FX	S2H0M08FX	S2H0M08FX	S2H0M08FX	S2H0M08FX	S2H0M08FX	S2H0M08FX	S2H0M08FX	S2H0M08FX	S2H0M08FX	S2H0M08FX	S2H0M08FX	S2H0M08FX	S2H0M08FX	S2H0M08FX	S2H0M08FX	S2H0M08FX
64" Open Throat Inlet	Open Throat (MM)	N/A	64	5.8	2.5	1.7	N/A	S2H0M10FX	S2H0M10FX	S2H0M10FX	S2H0M10FX	S2H0M10FX	S2H0M10FX	S2H0M10FX	S2H0M10FX	S2H0M10FX	S2H0M10FX	S2H0M10FX	S2H0M10FX	S2H0M10FX	S2H0M10FX	S2H0M10FX	S2H0M10FX	S2H0M10FX
48" Open Throat with Side Wings	Open Throat (MM)	N/A	48	Winged	5.1	2.7	1.7	N/A	S2H0M11FX	S2H0M11FX	S2H0M11FX	S2H0M11FX	S2H0M11FX	S2H0M11FX	S2H0M11FX	S2H0M11FX	S2H0M11FX	S2H0M11FX	S2H0M11FX	S2H0M11FX	S2H0M11FX	S2H0M11FX	S2H0M11FX	S2H0M11FX
12" x 12" precast	Concrete Box (HD)	15 x 15	12 x 12	0.9	1.0	0.7	2.4	S2H012FX	S2H012FX	S2H012FX	S2H012FX	S2H012FX	S2H012FX	S2H012FX	S2H012FX	S2H012FX	S2H012FX	S2H012FX	S2H012FX	S2H012FX	S2H012FX	S2H012FX	S2H012FX	S2H012FX
18" x 18" precast	Concrete Box (HD)	21 x 18	18 x 18	2.0	1.5	1.0	3.7	S2H018FX	S2H018FX	S2H018FX	S2H018FX	S2H018FX	S2H018FX	S2H018FX	S2H018FX	S2H018FX	S2H018FX	S2H018FX	S2H018FX	S2H018FX	S2H018FX	S2H018FX	S2H018FX	S2H018FX
21" Round Opening	Round (RD)	23	21	1.5	1.3	1.1	4.5	S2H021FX	S2H021FX	S2H021FX	S2H021FX	S2H021FX	S2H021FX	S2H021FX	S2H021FX	S2H021FX	S2H021FX	S2H021FX	S2H021FX	S2H021FX	S2H021FX	S2H021FX	S2H021FX	S2H021FX
24" Round Opening	Round (RD)	26	24	1.9	1.5	1.3	4.9	S2H024FX	S2H024FX	S2H024FX	S2H024FX	S2H024FX	S2H024FX	S2H024FX	S2H024FX	S2H024FX	S2H024FX	S2H024FX	S2H024FX	S2H024FX	S2H024FX	S2H024FX	S2H024FX	S2H024FX
24" x 24" (shallow)	Concrete Box (HD)	27 x 24	24 x 24	3.2	1.9	0.8	6.1	S2H024FX	S2H024FX	S2H024FX	S2H024FX	S2H024FX	S2H024FX	S2H024FX	S2H024FX	S2H024FX	S2H024FX	S2H024FX	S2H024FX	S2H024FX	S2H024FX	S2H024FX	S2H024FX	S2H024FX
24" x 24" (medium)	Concrete Box (HD)	27 x 24	24 x 24	3.2	1.9	0.8	6.1	S2H024FX	S2H024FX	S2H024FX	S2H024FX	S2H024FX	S2H024FX	S2H024FX	S2H024FX	S2H024FX	S2H024FX	S2H024FX	S2H024FX	S2H024FX	S2H024FX	S2H024FX	S2H024FX	S2H024FX
30" x 18" precast	Concrete Box (HD)	40 x 18	36 x 18	3.8	2.2	1.5	5.8	S2H030FX	S2H030FX	S2H030FX	S2H030FX	S2H030FX	S2H030FX	S2H030FX	S2H030FX	S2H030FX	S2H030FX	S2H030FX	S2H030FX	S2H030FX	S2H030FX	S2H030FX	S2H030FX	S2H030FX
30" x 18" precast	Concrete Box (HD)	40 x 18	36 x 18	3.5	2.1	1.5	6.9	S2H030FX	S2H030FX	S2H030FX	S2H030FX	S2H030FX	S2H030FX	S2H030FX	S2H030FX	S2H030FX	S2H030FX	S2H030FX	S2H030FX	S2H030FX	S2H030FX	S2H030FX	S2H030FX	S2H030FX
30" x 24" precast	Concrete Box (HD)	40 x 24	36 x 24	3.9	2.5	1.7	6.5	S2H030FX	S2H030FX	S2H030FX	S2H030FX	S2H030FX	S2H030FX	S2H030FX	S2H030FX	S2H030FX	S2H030FX	S2H030FX	S2H030FX	S2H030FX	S2H030FX	S2H030FX	S2H030FX	S2H030FX
30" x 24" precast	Concrete Box (HD)	40 x 24	36 x 32	4.3	2.3	2.0	5.8	S2H030FX	S2H030FX	S2H030FX	S2H030FX	S2H030FX	S2H030FX	S2H030FX	S2H030FX	S2H030FX	S2H030FX	S2H030FX	S2H030FX	S2H030FX	S2H030FX	S2H030FX	S2H030FX	S2H030FX
30" x 30" precast	Concrete Box (HD)	40 x 36	36 x 36	7.2	4.4	3.2	9.6	S2H030FX	S2H030FX	S2H030FX	S2H030FX	S2H030FX	S2H030FX	S2H030FX	S2H030FX	S2H030FX	S2H030FX	S2H030FX	S2H030FX	S2H030FX	S2H030FX	S2H030FX	S2H030FX	S2H030FX
48" x 48" precast	Concrete Box (HD)	48 x 48	48 x 48	13.0	5.4	4.2	11.4	S2H048FX	S2H048FX	S2H048FX	S2H048FX	S2H048FX	S2H048FX	S2H048FX	S2H048FX	S2H048FX	S2H048FX	S2H048FX	S2H048FX	S2H048FX	S2H048FX	S2H048FX	S2H048FX	S2H048FX

NOTES:

- ALL FRAMING IS CONSTRUCTED OF 304 STAINLESS STEEL FOR 25 YEAR SERVICE LIFE RATING.
- TOTAL BYPASS CAPACITY WILL VARY WITH EACH SIZED DRAINAGE STRUCTURE. FLEXSTORM DESIGNS FRAMING BYPASS TO MEET OR EXCEED THE DESIGN FLOW OF THE PARTICULAR DRAINAGE STRUCTURE.
- UPON ORDERING ADD P/N CONFIRMATION OF THE DOT CALLOUT, FLEXSTORM ITEM CODE, CASTING MAKE AND MODEL, OR DETAILED DIMENSIONAL FORMS MUST BE PROVIDED.
- FOR WRITTEN SPECIFICATIONS AND MAINTENANCE GUIDELINES VISIT WWW.INLETFILTERS.COM

FLEXSTORM PURE ADS

ALL PRODUCTS MANUFACTURED BY INLET & PIPE PROTECTION, INC. A DIVISION OF ADS, INC. WWW.INLETFILTERS.COM (951) 287-8655 PH (630) 355-3477 FX INFO@INLETFILTERS.COM

DATE: 05/20/2018
SCALE: 1"=40'
SHEET 1 OF 1

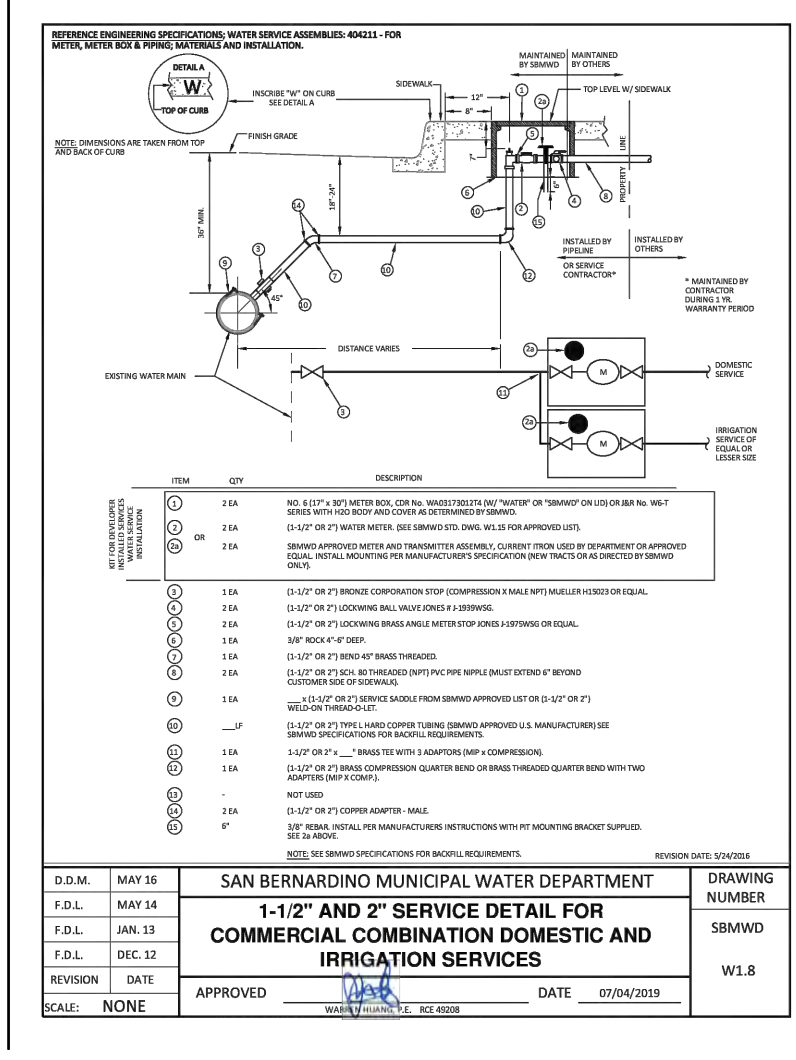
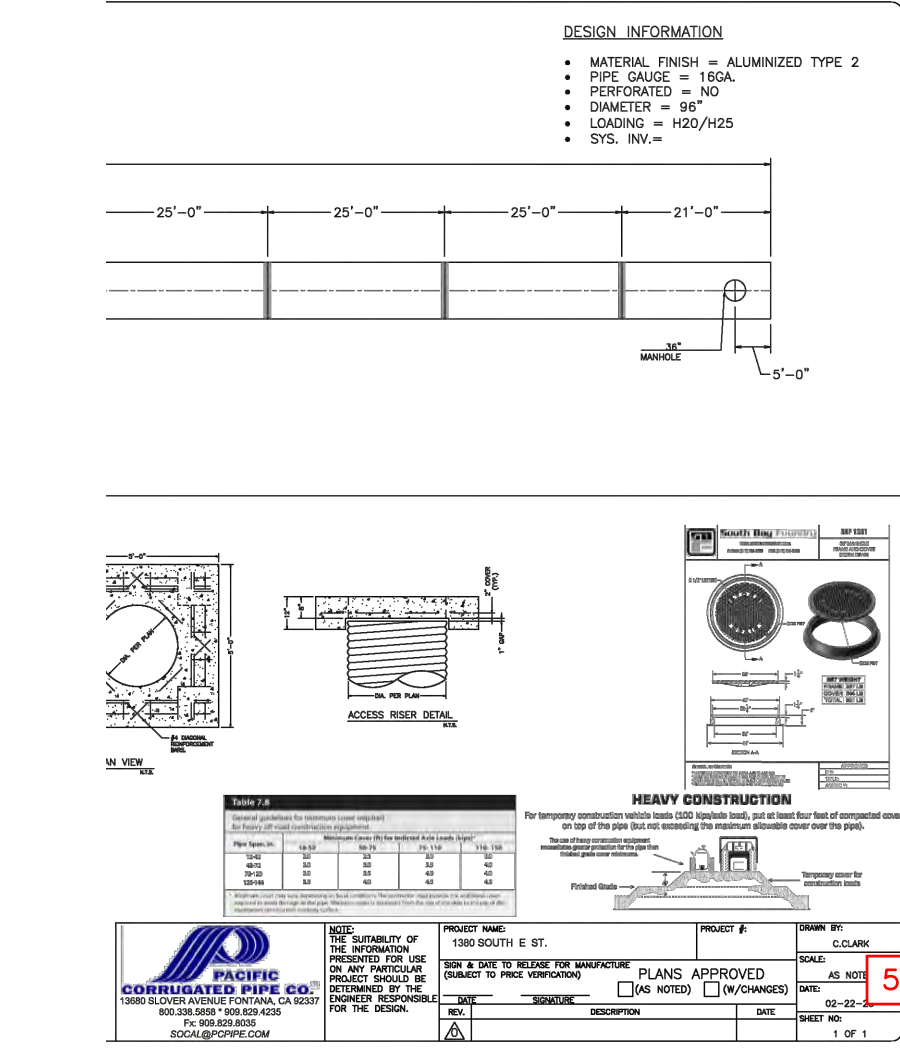
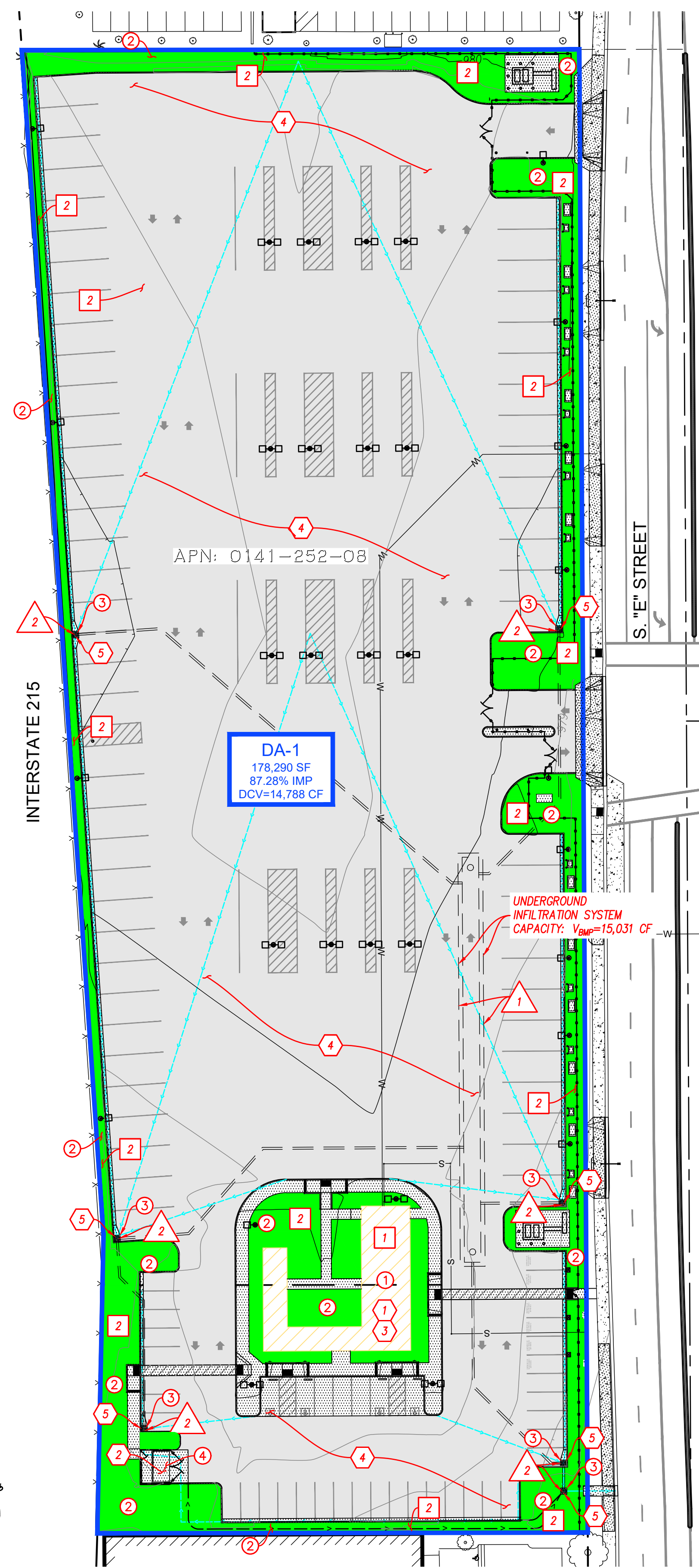

2), APPENDIX A, 2015 CPC. 3:



FINAL W.Q.M.P.
1388 S. "E" STREET
SAN BERNARDINO, CA 92408
A.P.N. 0141-252-08

PREPARED FOR: WATTEV		SCALE: 1" = 40'		SHEET: 1 OF 1	
DRAWN BY: K.B.O.	CHECKED BY:	JOB NO: 225025	DATE: 04-07-23		
DISREGARD PRINTS BEARING EARLIER REVISION DATES					

BENADIMAN
JOSEPH E. BENADIMAN & ASSOCIATES, INC.
ENGINEERS - E.I.T. - SURVEYORS - PLANNERS
TEL: (909) 885-3806
FAX: (909) 371-4721
WWW.BENADIMAN.COM

Appendix 6.2 – Electronic Data Submittal

Note: A cd containing PDF versions of the WQMP documents will be included in this section during final engineering, when requested by the reviewing agency.

Appendix 6.3 – Post Construction

Note: As indicated in section 8.2.3 of the “Technical Guidance Document for Water Quality Management Plans”, dated June 7, 2013, a maintenance agreement may be required by local jurisdiction for proposed BMPs. A maintenance agreement will be provided in this section if requested by the local jurisdiction.

Appendix 6.4 – Other Supporting Documentation



WQMP Project Report

County of San Bernardino Stormwater Program

Santa Ana River Watershed Geodatabase

Monday, March 21, 2022

Note: The information provided in this report and on the Stormwater Geodatabase for the County of San Bernardino Stormwater Program is intended to provide basic guidance in the preparation of the applicant's Water Quality Management Plan (WQMP) and should not be relied upon without independent verification.

Project Site Parcel Number(s):	014131202, 014125203, 014125302
Project Site Acreage:	12.556
HCOE Exempt Area:	Yes. Verify that the project is completely within the HCOE exemption area.
Closest Receiving Waters: <small>(Applicant to verify based on local drainage facilities and topography.)</small>	System Number - 409 Facility Name - Twin Creek Channel Improved, COE Owner - SBCFCD
Closest channel segment's susceptibility to Hydromodification:	EHM
Highest downstream hydromodification susceptibility:	High
Is this drainage segment subject to TMDLs?	No
Are there downstream drainage segments subject to TMDLs?	No
Is this drainage segment a 303d listed stream?	No
Are there 303d listed streams downstream?	Yes
Are there unlined downstream waterbodies?	No
Project Site Onsite Soil Group(s):	A
Environmentally Sensitive Areas within 200':	SAN BERNARDINO KANGAROO RAT
Groundwater Depth (FT):	-140
Parcels with potential septic tanks within 1000':	No
Known Groundwater Contamination Plumes within 1000':	No
Studies and Reports Related to Project Site:	CSDP No. 7 Storm Drain Systems CSDP No. 7 Storm Drain Systems CSDP No. 7 Storm Drain Systems CSDP No. 7 Storm Drain Hydraulic Design Data Upper Lytle Creek Drainage Investigation SBVMWD High Groundwater / Pressure Zone Area



NOAA Atlas 14, Volume 6, Version 2
Location name: San Bernardino, California, USA*
Latitude: 34.0736°, Longitude: -117.2948°
Elevation: 976.81 ft**



* source: ESRI Maps
 ** source: USGS

POINT PRECIPITATION FREQUENCY ESTIMATES

Sanja Perica, Sarah Dietz, Sarah Heim, Lillian Hiner, Kazungu Maitaria, Deborah Martin, Sandra Pavlovic, Ishani Roy, Carl Trypaluk, Dale Unruh, Fenglin Yan, Michael Yekta, Tan Zhao, Geoffrey Bonnin, Daniel Brewer, Li-Chuan Chen, Tye Parzybok, John Yarchoan

NOAA, National Weather Service, Silver Spring, Maryland

[PF_tabular](#) | [PF_graphical](#) | [Maps_&_aerials](#)

PF tabular

PDS-based point precipitation frequency estimates with 90% confidence intervals (in inches)¹										
Duration	Average recurrence interval (years)									
	1	2	5	10	25	50	100	200	500	1000
5-min	0.102 (0.085-0.123)	0.133 (0.110-0.161)	0.174 (0.144-0.212)	0.208 (0.171-0.255)	0.254 (0.202-0.324)	0.291 (0.226-0.378)	0.328 (0.249-0.437)	0.367 (0.271-0.504)	0.421 (0.297-0.602)	0.463 (0.315-0.686)
10-min	0.146 (0.121-0.177)	0.190 (0.158-0.231)	0.249 (0.207-0.304)	0.298 (0.245-0.366)	0.365 (0.290-0.464)	0.417 (0.324-0.542)	0.470 (0.357-0.627)	0.526 (0.388-0.722)	0.603 (0.426-0.863)	0.664 (0.452-0.984)
15-min	0.176 (0.147-0.214)	0.230 (0.191-0.280)	0.301 (0.250-0.367)	0.360 (0.296-0.443)	0.441 (0.350-0.561)	0.504 (0.392-0.655)	0.569 (0.431-0.758)	0.636 (0.469-0.873)	0.729 (0.515-1.04)	0.802 (0.547-1.19)
30-min	0.262 (0.219-0.318)	0.342 (0.285-0.416)	0.449 (0.372-0.546)	0.536 (0.441-0.658)	0.656 (0.521-0.834)	0.750 (0.583-0.974)	0.846 (0.642-1.13)	0.947 (0.698-1.30)	1.09 (0.766-1.55)	1.19 (0.813-1.77)
60-min	0.379 (0.316-0.460)	0.495 (0.411-0.601)	0.648 (0.537-0.789)	0.774 (0.637-0.951)	0.948 (0.753-1.21)	1.08 (0.842-1.41)	1.22 (0.927-1.63)	1.37 (1.01-1.88)	1.57 (1.11-2.24)	1.73 (1.18-2.56)
2-hr	0.544 (0.453-0.660)	0.700 (0.582-0.850)	0.905 (0.751-1.10)	1.07 (0.883-1.32)	1.30 (1.04-1.66)	1.48 (1.15-1.93)	1.66 (1.26-2.22)	1.85 (1.36-2.54)	2.11 (1.49-3.02)	2.31 (1.57-3.42)
3-hr	0.670 (0.558-0.812)	0.857 (0.712-1.04)	1.10 (0.914-1.34)	1.30 (1.07-1.60)	1.58 (1.25-2.01)	1.79 (1.39-2.33)	2.01 (1.52-2.67)	2.23 (1.64-3.06)	2.53 (1.79-3.62)	2.77 (1.89-4.10)
6-hr	0.929 (0.774-1.13)	1.18 (0.985-1.44)	1.52 (1.26-1.85)	1.79 (1.47-2.20)	2.16 (1.72-2.75)	2.45 (1.90-3.18)	2.74 (2.08-3.65)	3.03 (2.24-4.16)	3.44 (2.43-4.92)	3.75 (2.55-5.56)
12-hr	1.23 (1.02-1.49)	1.57 (1.31-1.91)	2.02 (1.68-2.47)	2.39 (1.97-2.94)	2.89 (2.29-3.67)	3.27 (2.54-4.24)	3.65 (2.77-4.87)	4.05 (2.98-5.55)	4.58 (3.23-6.55)	4.99 (3.40-7.40)
24-hr	1.63 (1.44-1.88)	2.11 (1.87-2.44)	2.74 (2.41-3.17)	3.25 (2.84-3.78)	3.93 (3.33-4.74)	4.46 (3.70-5.48)	4.99 (4.04-6.28)	5.53 (4.36-7.16)	6.26 (4.74-8.45)	6.83 (5.00-9.52)
2-day	1.98 (1.75-2.28)	2.60 (2.30-3.00)	3.42 (3.02-3.96)	4.09 (3.58-4.77)	5.00 (4.23-6.02)	5.69 (4.72-7.00)	6.41 (5.19-8.07)	7.14 (5.63-9.24)	8.13 (6.15-11.0)	8.90 (6.51-12.4)
3-day	2.11 (1.87-2.43)	2.81 (2.49-3.25)	3.75 (3.31-4.34)	4.53 (3.96-5.28)	5.58 (4.73-6.73)	6.41 (5.32-7.88)	7.25 (5.87-9.13)	8.13 (6.40-10.5)	9.32 (7.06-12.6)	10.3 (7.51-14.3)
4-day	2.25 (1.99-2.59)	3.03 (2.68-3.49)	4.07 (3.59-4.71)	4.94 (4.32-5.76)	6.13 (5.19-7.39)	7.07 (5.86-8.69)	8.03 (6.50-10.1)	9.03 (7.12-11.7)	10.4 (7.88-14.0)	11.5 (8.41-16.0)
7-day	2.57 (2.28-2.97)	3.51 (3.11-4.05)	4.78 (4.21-5.53)	5.83 (5.10-6.79)	7.28 (6.17-8.77)	8.43 (6.99-10.4)	9.61 (7.78-12.1)	10.8 (8.54-14.0)	12.5 (9.50-16.9)	13.9 (10.2-19.4)
10-day	2.79 (2.47-3.21)	3.84 (3.39-4.43)	5.25 (4.63-6.08)	6.43 (5.63-7.50)	8.07 (6.84-9.73)	9.37 (7.77-11.5)	10.7 (8.67-13.5)	12.1 (9.55-15.7)	14.1 (10.6-19.0)	15.6 (11.4-21.8)
20-day	3.40 (3.01-3.92)	4.74 (4.19-5.47)	6.55 (5.78-7.58)	8.08 (7.07-9.42)	10.2 (8.65-12.3)	11.9 (9.89-14.7)	13.7 (11.1-17.2)	15.5 (12.3-20.1)	18.1 (13.7-24.5)	20.2 (14.8-28.2)
30-day	4.02 (3.56-4.64)	5.61 (4.96-6.47)	7.78 (6.86-9.00)	9.61 (8.41-11.2)	12.2 (10.3-14.7)	14.2 (11.8-17.5)	16.4 (13.3-20.6)	18.6 (14.7-24.1)	21.8 (16.5-29.4)	24.3 (17.8-34.0)
45-day	4.81 (4.26-5.54)	6.68 (5.90-7.70)	9.24 (8.15-10.7)	11.4 (9.98-13.3)	14.5 (12.3-17.4)	16.9 (14.0-20.8)	19.5 (15.8-24.6)	22.2 (17.5-28.8)	26.0 (19.7-35.1)	29.1 (21.3-40.6)
60-day	5.62 (4.98-6.48)	7.74 (6.85-8.93)	10.7 (9.40-12.3)	13.1 (11.5-15.3)	16.6 (14.1-20.0)	19.4 (16.1-23.9)	22.4 (18.1-28.2)	25.5 (20.1-33.0)	29.9 (22.6-40.3)	33.4 (24.4-46.6)

¹ Precipitation frequency (PF) estimates in this table are based on frequency analysis of partial duration series (PDS). Numbers in parenthesis are PF estimates at lower and upper bounds of the 90% confidence interval. The probability that precipitation frequency estimates (for a given duration and average recurrence interval) will be greater than the upper bound (or less than the lower bound) is 5%. Estimates at upper bounds are not checked against probable maximum precipitation (PMP) estimates and may be higher than currently valid PMP values. Please refer to NOAA Atlas 14 document for more information.

[Back to Top](#)

PF graphical

PDS-based depth-duration-frequency (DDF) curves
Latitude: 34.0736°, Longitude: -117.2948°

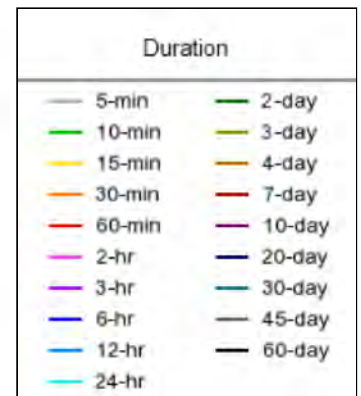
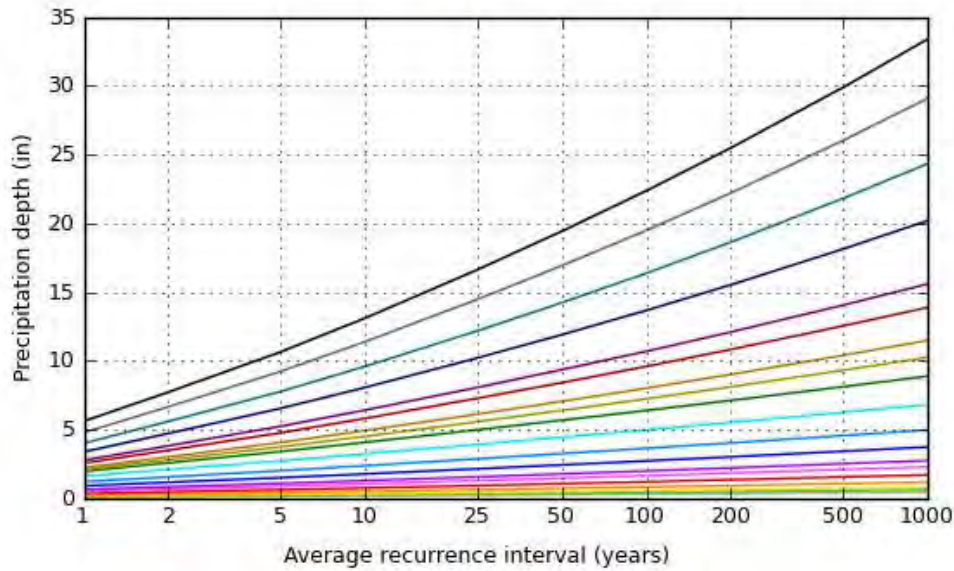
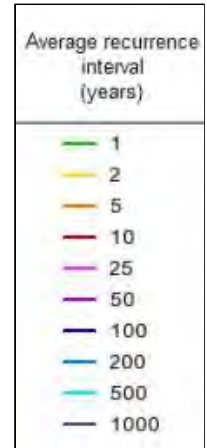
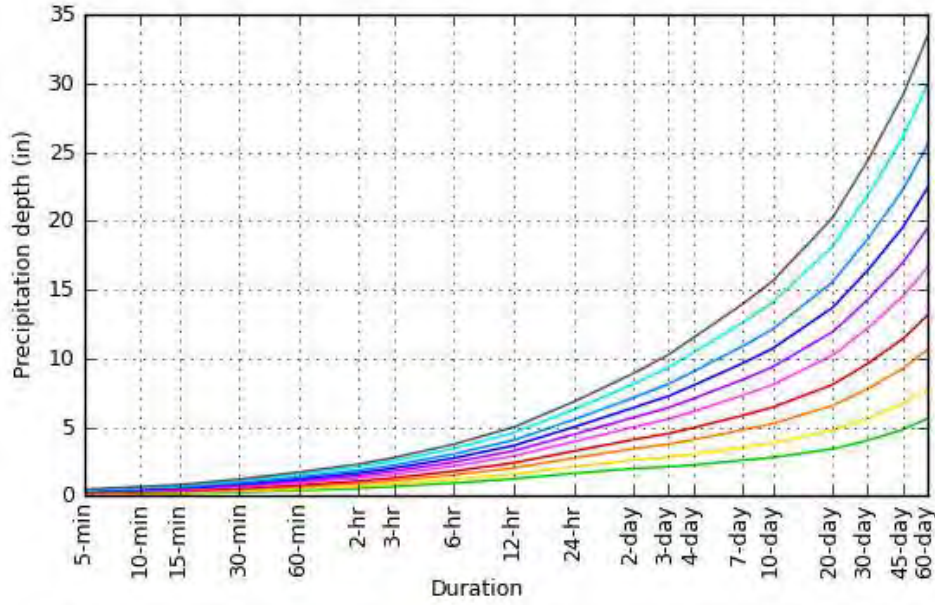

[Back to Top](#)

Maps & aeriels

Small scale terrain



Large scale terrain



Large scale map



Large scale aerial

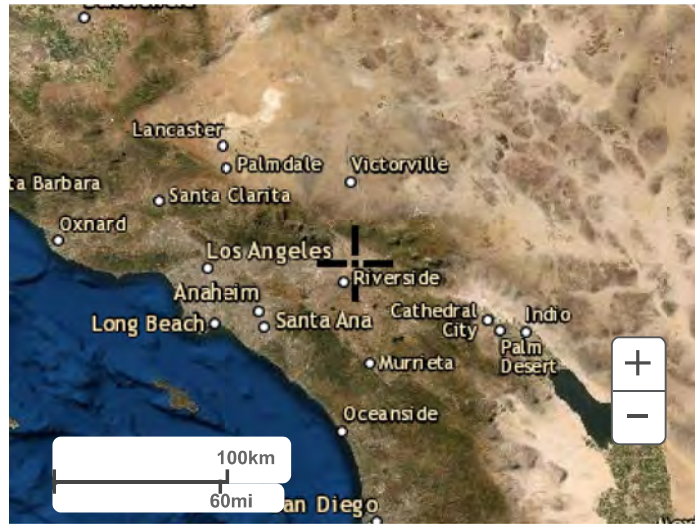

[Back to Top](#)

[US Department of Commerce](#)
[National Oceanic and Atmospheric Administration](#)
[National Weather Service](#)
[National Water Center](#)
1325 East West Highway
Silver Spring, MD 20910
Questions?: HDSC.Questions@noaa.gov

[Disclaimer](#)



SOILS SOUTHWEST, INC.

SOILS, MATERIALS AND ENVIRONMENTAL ENGINEERING CONSULTANTS

897 VIA LATA, SUITE N • COLTON, CA 92324 • (909) 370-0474 • (909) 370-0481 • FAX (909) 370-3156

**Report of Geotechnical Evaluations and
Soils Infiltration Testing for WQMP-BMP Stormwater Disposal System Design**

Planned EV Truck Leasing Service Facility

1380 S. E Street

San Bernardino, California

APN: 0141-252-08

Project No. 22051-F/BMP

October 20, 2022

Prepared for:

Watt Ev, Inc.

% Mr. Emil Youssefsadeh

222 North Pacific Coast Highway

El Segundo, CA 90245



SOILS SOUTHWEST, INC.

SOILS, MATERIALS AND ENVIRONMENTAL ENGINEERING CONSULTANTS

897 VIA LATA, SUITE N • COLTON, CA 92324 • (909) 370-0474 • (909) 370-0481 • FAX (909) 370-3156

October 20, 2022

Project No. 22051-F/BMP

WattEV SB1, Inc.
222 North Pacific Coast Highway
El Segundo, CA 90245

Attention: Mr. Emil Youssefsadeh

Subject: Report of Geotechnical Evaluations and
Soils Infiltration Testing for WQMP-BMP Stormwater Disposal System Design
Planned EV Truck Leasing Service Facility
1380 S. E Street
San Bernardino, California
APN: 0141-252-08

Reference: Proposed Site Plan Provided by Joseph E. Bonadiman & Associates

Dear Mr. Youssefsadeh,

Presented herewith is the report of (i) Geotechnical Evaluations and (ii) Soils Infiltration Testing for WQMP-BMP Stormwater Disposal System Design for the site of the proposed EV Truck Leasing Service Facility to be constructed at 1380 S. E Street, San Bernardino, California. In absence of detailed development plans, the recommendations included should be considered as "preliminary" and subject to revision following detailed development plans review.

Based on review of the referenced site plan, it is understood that the subject development will primarily include a non-habitable one or two-story office building along with open-air concrete paving and parking stalls with electrical vehicle charging bays and 25 to 40-foot-wide drive approaches. In absence of detailed development plans review, the subject structure is assumed of concrete framed, concrete block, and/or conventional wood frame and stucco construction with concrete slabs-on-grade. Supplemental construction is anticipated to include paving for truck traffic, trucks/autos parking, on-site driveways along with the installation of an underground WQMP-BMP stormwater disposal chamber system.

Based on test explorations and geotechnical investigations completed the following site soils characteristics are described:

- (i) The soils encountered primarily consist of upper loose to medium dense dry to damp silty fine to medium coarse sands varying in depth from approximately 3 to 5 feet below grade, overlying deposits of medium dense to dense gravely medium to coarse sands with pebbles, cobbles, and rocks to the maximum depth of 31 feet explored. Descriptions of the soils encountered are provided in the attached Log of Borings.
- (ii) With historical groundwater at approximately 9 feet below grade, the site soils are considered susceptible to seismically induced soil liquefaction and moderately high total soil differential settlements.
- (iii) Although the site is not identified to be located within an A-P Special Studies Zone, it is, however, located 0.16-mile away from the nearest San Jacinto fault thereby requiring appropriate structural design based on the design parameters described herein.

- (iv) Following review of the online FEMA National Flood Hazard Layer FIRMette map, it is understood that the project site is classified as Zone X, 0.2% Annual Chance of Flood Hazard Area.
- (v) For design, anticipated structural loadings of 40 kips and 4 klf are assumed for isolated foundations and continuous spread footings, respectively. Moderate site preparations and grading should be expected with the proposed development.
- (vi) For the planned development, it is our opinion that for adequate structural support moderate site preparations and grading should be considered. In addition, to minimize potentials for total and differential settlements to foundations and concrete slabs-on-grade, use of a layer of biaxial geogrid such as Tensor BX1100 or approved equal overlain by a 2-foot-thick layer of clean 2 to 3-inch diameter crushed rock to minimize potential for settlement due to soil liquefaction.

Based on evaluations completed at this time, it is our opinion that from a geotechnical viewpoint, the site should be considered suitable for the proposed development considering the recommendations are included.

Final grading and detailed development plans review is suggested to verify the applicability of the assumptions used in preparing this report. This report has been substantiated by subsurface explorations and mathematical analyses made in accordance with the generally accepted engineering principles, including those field and laboratory testing considered necessary in these circumstances.

We offer no other warranty, express or implied.

Respectfully submitted,
Soils Southwest, Inc.

Moloy Gupta, RCE



A handwritten signature in blue ink, appearing to read "Patricia Partas".

Patricia Partas, P.E. (WA), PMP

John Flippin
Project Coordinator

1.0 Introduction

This report presents the findings, opinions, and recommendations for (i) Geotechnical Evaluations and (ii) Soils Infiltration Testing for WQMP-BMP Stormwater Disposal System Design for the site of the proposed EV Truck Leasing Service Facility to be constructed at 1380 S. E Street, San Bernardino, California. The WQMP-BMP stormwater disposal infiltration rates are included in Section 6 of this report.

1.1 Site Description

The semi-rectangular shaped area of the planned development measuring approximately 270 feet x 598 feet in plan dimensions is currently vacant and undeveloped with old existing asphalt pavement and abandoned concrete slabs. The site is bounded by San Bernardino Municipal Water campus to the north, by Sherwinn Williams commercial retail on the south, by South E Street on the east, and by northbound Interstate Highway 215 on the west. Overall vertical relief within the property is currently unknown; however, based on site reconnaissance sheet flow from incidental rainfall appears to flow gently towards the south and southwest. Except for weeds, old concrete slabs, and asphalt pavement along with scattered debris, presence of no other significant features was noted.

1.2 Proposed Development

No detailed development plans are available for review; however, based on the project site plan supplied, it is understood that the subject development will primarily include a 2660 sf non-habitable one or two-story office structure. In absence of detailed development plans review, the subject structure is assumed of concrete framed, concrete block and/or conventional wood frame and stucco construction with concrete slabs-on-grade. Supplemental construction is anticipated to include paving for truck traffic, trucks/autos parking, on-site driveways along with the installation of an underground WQMP-BMP stormwater disposal chamber system. For design, anticipated structural loadings of 40 kips and 4 klf are assumed for isolated foundations and continuous spread footings, respectively.

Moderate site preparations and grading are anticipated as described in the following sections.

The purpose of the geotechnical evaluations is to determine the nature and engineering properties of the near grade and subsurface soils and to provide recommendations for foundation design, concrete slab-on-grade, paving, parking, site preparations and grading, and inspection during construction.

The recommendations contained reflect our best estimate of the soils' conditions as encountered and as described. It is not to be considered as a warranty of the soils for other areas or for the depths beyond the explorations completed at this time.

The recommendations supplied should be considered valid and applicable when the following conditions are observed:

- i. Pre-grade meeting with the contractor, public agency, and the soils engineer,
- ii. Excavated bottom inspections and verifications of excavated bottoms prior to engineered fill soils placement,
- iii. Continuous observations and testing during site preparation and mass grading,
- iv. Observation and inspection of footing trenches prior to steel and concrete placement,
- v. Plumbing trenches backfill placement prior to concrete slabs-on-grade placement,
- vi. On and off-site utility trenches backfill observations testing and verifications, and
- vii. Consultations as required during construction or upon your request.

In absence of precise grading plan, the geotechnical recommendations supplied should be considered "preliminary". Supplemental recommendations may be warranted following development details review.

2.0 Scope of Services

Geotechnical evaluations included subsurface explorations, soil sampling, necessary laboratory testing, engineering analyses, and the preparation of this report. Being beyond our scope of services, no geologic evaluations or Phase 1 Environmental Site Assessments are included. Reports of such will be provided upon request.

In general, our Scope of Services included the following:

o **Field Explorations**

Our scope of work included site reconnaissance and review of the referenced site plan supplied, supplemented with six (6) test borings (B-1 to B-6) explored by using a Hollow-Stem Auger (HSA) drill rig advanced to maximum depth of 31 feet below grade. Additional two (2) infiltration test borings were also made advanced to maximum depth of 12 feet (P-1 & P-2) below grade for determination of WQMP-BMP stormwater infiltration rates considering the groundwater depth at 95.3 feet as measured on November 29, 2010.

Prior to test explorations an underground utility clearance was established with Underground Service Alert (USA) of Southern California to avoid possible subsurface lifeline obstruction and rupture. Following necessary soil sampling and in-situ testing, the test excavations were backfilled with local soils using minimum compaction effort. Collected samples were subsequently transferred to our laboratory for necessary geotechnical testing. Approximate test boring locations are shown on the attached Plate 1.

During excavations, the soils encountered were continuously logged and bulk and undisturbed samples were procured. Collected samples were subsequently transferred to our laboratory for necessary geotechnical testing. Description of the soils encountered is shown on the attached Log of Borings in Appendix A.

o **Laboratory Testing**

Representative bulk and undisturbed site soils were tested in laboratory to aid in the soils' classification and to evaluate relevant engineering properties pertaining to the project requirements. The laboratory tests completed include the following:

- In-situ Moisture Contents and Dry Density (ASTM Standard D2216),
- Maximum Dry Density and Optimum Moisture Content (ASTM Standard D1557),
- Direct Shear (ASTM Standard D3080),
- Soil Consolidation (ASTM Standard D2435),
- Soils Sieve Analysis (ASTM D422), and
- Soils Sand Equivalent, SE (ASTM D2419).

No soils chemical analysis is currently included. Post-grading soil chemical analyses are suggested including pH, sulfate, chloride, and resistivity. Such analyses should be performed upon request prior to actual construction and concrete pour.

Description of the test results and test procedures used are provided in Appendix B of this report.

- o Based on the test explorations, soil sampling, laboratory testing, and engineering analyses completed at this time, our preliminary recommendations for design of foundations, slab-on-grade, paving and parking, site preparations and grading, and monitoring during construction are described.

Preparation of this report for initial use by the project design professionals. The recommendations herein should be considered as "preliminary" and subject to revision and upgrading following review of the final grading and development plans, when supplied.

3.0 Geotechnical Conditions

3.1 Subsurface Conditions

The soils encountered, in general, primarily consist of upper loose and disturbed dry to damp silty fine to medium coarse sands varying in depth from approximately 3 to 5 feet below grade, overlying deposits of medium dense to dense gravelly medium to coarse sands with pebbles, cobbles, and rocks to the maximum depth of 31 feet explored. Descriptions of the soils encountered are provided in the attached Log of Borings (B-1 to B-6). Based on review of the USDA Natural Resources Conservation Service: Web Soil Survey for the subject area, it is our understanding that the soil classification for the subject area is identified as being TvC-Tujunga gravelly loamy sand, 0% to 9% slopes consisting of upper 36 inches of gravelly loamy sands overlying gravelly sands.

Based on the information published by the Department of Conservation, State of California, it is understood that the site is not situated within an A-P Special Study Zone where a known seismic fault passes through the site or its adjacent; however, given that the site being located within 0.16-mile to the nearest San Jacinto fault, appropriate structural design should be performed using the seismic design parameters described herein.

Following review of the online FEMA National Flood Hazard Layer FIRMette map, it is understood that the project site is classified as Zone X, 0.2% Annual Chance of Flood Hazard Area.

The near grade soils consisting of disturbed soils, cobbles, rocks with occasional concrete chunks, and debris existing as described are considered unsuitable for directly supporting structural loadings without excessive differential settlements to load bearing footings and concrete slabs-on-grade. It is our opinion, however, that for structural support when the upper minimum 5 feet of the disturbed soils are graded in the form of subexcavations and their replacement as engineered fills free of rocks, concrete chunks, and debris compacted to minimum 95%, the structural pads thus constructed should be considered adequate for the planned development with "tolerable" settlements. For paving/parking, site grading should include minimum 2 feet subexcavations and their replacement as engineered fills similarly compacted to 95%.

Laboratory shear tests conducted on the upper soils remolded to 90% indicate moderate shear strengths under increased moisture conditions. Results of the laboratory shear tests are provided on Plate B.

Consolidation tests conducted on remolded samples indicate "low" potential for compressibility under anticipated static structural loadings with potential for "tolerable" settlements to footings and concrete slabs-on-grade. Results of the laboratory determined soils consolidation potential is shown in Appendix B.

Fine to coarse silty gravelly sands with scattered rocks and cobbles encountered as described are considered "very low" in expansion potential requiring no special construction requirements other than those as recommended herein. Supplemental soil expansion testing, however, is recommended following mass grading completion to provide supplemental/revised foundation recommendations, if warranted.

During site preparations and grading, buried irrigation, debris, organics, and others may be encountered. In addition, variations in soil strata, their continuity and orientations may be expected. Due to the deposition characteristics of the soils encountered, care should be exercised in interpolating or extrapolating the subsurface soils conditions existing in between and beyond the test explorations conducted.

3.2 Excavatability

It is our opinion that the grading required for the project may be accomplished by using conventional heavy-duty construction equipment. No blasting or jackhammering should be warranted.

3.3 Subsurface Variations

Based on the results of subsurface explorations and local experience from similar projects completed as of this date, it is our opinion that variations in subsoils continuity and depths of subsoils deposit may be expected. Due to the nature and depositional characteristics of the soils underlying as described, it is our opinion that care should be exercised in interpolating and/or extrapolating of the subsurface conditions existing in between and beyond the test explorations described. Although not encountered, presence of underlying old, buried utilities may be expected during grading and construction.

3.4 Groundwater

No groundwater was encountered within the maximum depth of 31 feet explored. The following table describes the historical and the current groundwater level as recorded at the nearest well as listed by the local reporting agency.

GROUNDWATER TABLE	
Reporting Agency	California Department of Water Resources Marcelo Montagna 2008 Maps http://wdl.water.ca.gov/waterdatalibrary/
Well Number	01S/04W-22D002S
Well Monitoring Agency	USGS/CA Department of Water Resources
Well Location: Township/Range/Section	T01N-R04W-Section 22
Well Elevation:	978.63
Current Depth to Water (Measured in feet)	95.3
Current Date Water was Measured	November 29,2010
Depth to Water (Measured in feet) (Shallowest)	9.13
Date Water was Measured	April 8, 1992

Fluctuations in groundwater levels, however, can occur due to seasonal variations in the amount of rainfall, runoff, altered natural drainage paths, and other factors not evident at the time the test borings were completed. Accordingly, for the planned development, it is our opinion that provisions should be maintained to dispose incidental surface runoff away from the individual structural pads once constructed.

3.5 Soil Corrosivity Analyses

Since change in soil chemical contents are expected to vary considerably following site preparations and grading, no laboratory soils chemical evaluations are currently evaluated to determine soil corrosivity potential. Following mass grading completions, evaluations of such are recommended for the soils expected in contact with concrete and metals. Evaluations of such should include, at a minimum, the pH, sulfate, chloride, and resistivity.

3.6 Faulting and Seismicity

Seismically induced site-specific potential hazards are discussed in the following sections.

3.6.1 Direct or Primary Seismic Hazards

Surface ground ruptures are associated with presence of nearby active fault and ground shaking representing primary or direct seismic hazards to structures. There are no known active or potentially active faults that pass through or towards the subject site, and the site is not situated within an A-P Special Studies Zone.

According to the current CBC, the site is considered within Seismic Zone 4. As a result, it is likely that during life expectancy of the structures built moderate to severe ground shaking may have potential for adverse effects on the site.

3.6.2 Induced or Secondary Seismic Hazards

In addition to ground shaking, effects of seismic activity may include potentials for soil liquefaction, differential settlements, ground lurching, landslides, lateral spreading, and earthquake induced flooding. Potential effects of such are described below.

3.6.2.1 Surface Fault Rupture

The site is not situated within an A-P Special Studies Zone. Based on review of existing geologic information, no major fault is noted to cross through or extends towards the site. The potential for surface rupture resulting from nearby fault movement is not known for certainty but in our opinion is considered "low"

3.6.2.2 Flooding

Flooding hazards include tsunamis (seismic sea waves), Seiches, and failure of manmade reservoirs, tanks, and aqueducts. In absence of bodies of water nearby, such potential is considered "remote". Based on review of the FEMA National Flood Hazard Layer FIRMette map, it is our understanding that the subject area is delineated as Zone X, 0.2% Annual Chance of Flood Hazard Area as shown in the attached Appendix C.

3.6.2.3 Landsliding

Seismically induced landslides and other slope failures are common occurrences during or soon after an earthquake. Considering that the site and its adjacent being relatively flat, it is our opinion that potential for seismically induced landslide should be considered as "remote".

3.6.2.4 Lateral Spreading

Seismically induced lateral spreading involves lateral movement of existing soils due to ground shaking. Lateral spreading is demonstrated by near vertical cracks with predominantly horizontal movement of the soil mass involved. The topography of the site being near level, it is our opinion that the potential for seismically induced lateral spreading should be considered as "remote".

3.6.2.5 Settlement and Subsidence

The site is situated at approximately 0.16 miles from the San Jacinto Fault capable of generating an earthquake magnitude, M of 7.8 and PGA of 0.653g. Considering the proximity of the earthquake fault as described, it is our opinion that potential for some total and differential settlements due to ground shaking may be expected, with severity increasing considerably due to potential for soil liquefaction. Based on site specific seismically induced settlement analysis using CivilTech Software, V5.2E LiquefyPro, it is our opinion that with a Factor of Safety, FS of 1, earthquake induced total and differential settlements for saturated and saturated soils (pre-construction) may be estimated to about 1.76-inch and 0.881-inch to 1.164-inch, respectively.

The results of the settlement analysis are provided in the following tables and supplemental details are provided in Appendix C.

TABLE 3.6.2.5 A1: Preliminary Settlement Analysis (Pre-Construction)

DYNAMIC SETTLEMENT	MEASURED IN INCHES
Settlement of Saturated Sands	1.57
Settlement of Unsaturated Sands	0.19
Total Settlement of Saturated and Unsaturated Sands	1.76
DIFFERENTIAL SETTLEMENT	0.881 to 1.164

TABLE 3.6.2.5 A2: Preliminary Settlement Analysis (Post-Construction)

DYNAMIC SETTLEMENT	MEASURED IN INCHES
Settlement of Saturated Sands	0.00
Settlement of Unsaturated Sands	0.03
Total Settlement of Saturated and Unsaturated Sands	0.03
DIFFERENTIAL SETTLEMENT	0.014 to 0.019

3.6.2.6 Liquefaction

Liquefaction is caused by build-up of excess hydrostatic pressure in saturated cohesionless soils due to cyclic stress generated by ground shaking during an earthquake. The significant factors on which liquefaction potential of a soil deposit depends, among others include, soil type, relative soil density, intensity of earthquake, duration of ground shaking, and depth of groundwater.

No shallow depth bedrock or groundwater was encountered within the maximum depth of 31 feet explored. Based on the available information published by California Department of Water Resources' online groundwater data library for well 01S/04W-22D002S with historical groundwater recorded at approximately 9 feet, and based on review of Special Publication 117A, published by the State of California Division of Mines and Geology, it is our opinion that the site is recognized to be highly susceptible to earthquake induced potential for soil liquefaction. The upper soils existing at their present state are considered susceptible to moderate deformation under conventional static structural loadings. Supplemental "excessive" ground settlements, as described herein, could be anticipated over a large area associated with potential for soil liquefaction during an earthquake.

3.6.3 Site Specific Seismic Effects

The site is situated at approximately 0.16 miles from the San Jacinto Fault capable of generating an earthquake magnitude, M of 7.8 and Peak Horizontal Ground Acceleration, PGA of 0.653g at 10% probability in a 50-year-return period. Considering the proximity of the earthquake fault as described, it is our opinion that potential for some total and differential settlements due to ground shaking may be anticipated as described in the previous section.

3.6.4 Seismic Design Coordinates

The design spectrum was developed based on the 2019 CBC. Site Coordinates of 34.075110°N, -117.294687°W were used to establish the seismic parameters presented below.

3.7 Seismic Design Coefficients

Recommended values are based upon the USGS ASCE 7-Hazard Reports Parameters and the California Geologic Survey: PSHA Ground Motion Interpolator Supplemental seismic parameters are provided in Appendix C of this report. The following presents the seismic design parameters as based on the available publications as currently published by the California Geological Survey and 2019 CBC. Supplemental seismic parameters are provided in Appendix C of this report.

TABLE 3.11 A1: Seismic Design Parameters

Seismic Source Type

Based on California Geological Survey-Probabilistic Seismic Hazard Assessment Peak Horizontal Ground Acceleration (PGA) having a 10% probability of exceedance in a 50-year-period is described as below:

Seismic Source Type	
Nearest Maximum Fault Magnitude	$M \geq 7.8$
Peak Horizontal Ground Acceleration (PGA)	0.653g

In design, vertical acceleration may be assumed to about 1/3 to 2/3 of the estimated horizontal ground accelerations described.

It should be noted that lateral force requirement in design by structural engineer should be intended to resist total structural collapse during an earthquake. During the lifetime use of the structure built, it is our opinion that some structural damage may be anticipated requiring some structural repairs. Adequate structural design and implementation of such in construction should be strictly observed. Use of flexible lifeline connections are suggested.

TABLE 3.11 A2: Seismic Design Coefficients

CBC Chapter 16	2019 ASCE 7-16 Standard Seismic Design Parameters	Recommended Values
1613A.5.2	Site Class	D
1613.5.1	The mapped spectral accelerations at short period	S_s
1613.5.1	The mapped spectral accelerations at 1.0-second period	S_1
1613A5.3(1)	Seismic Coefficient, S_s	2.445g
1613A5.3(2)	Seismic Coefficient, S_1	0.980g
1613A5.3(1)	Site Class D / Seismic Coefficient, F_a	1g
1613A5.3(2)	Site Class D / Seismic Coefficient, F_v	n/a
16A-37 Equation	Spectral Response Accelerations, $S_{Ms} = F_a S_s$	2.445g
16A-38 Equation	Spectral Response Accelerations, $S_{M1} = F_v S_1$	n/a
16A-39 Equation	Design Spectral Response Accelerations, $S_{Ds} = 2/3 \times S_{Ms}$	1.630g
16A-40 Equation	Design Spectral Response Accelerations, $S_{D1} = 2/3 \times S_{M1}$	n/a

4.0 Evaluations and Recommendations

4.1 General Evaluations

Based on field explorations, laboratory testing, and subsequent engineering analyses, the following tentative conclusions and recommendations are presented for initial study:

- (I) From a geotechnical viewpoint, the site is considered grossly stable for the proposed development, provided that the recommendations supplied herein are incorporated in design and construction. Foundation design should reflect considerations of the seismically induced PGA as described.
- (II) Based on the dry silty sandy variable consistency nature of the upper soils existing as encountered, it is our opinion that for structural support the load bearing soils should be reworked in the form of subexcavations, followed by scarification, dampurization, and their replacement as engineered fills compacted to minimum 95%. In the event that new fill soils are required over the current grade surface such should be placed on the original grades when prepared as described.
- (III) The subexcavation depths during mass grading as described in the following section should be considered as "minimum". During grading, localized deeper subexcavations may be required within areas underlain by buried debris, utilities, localized fills or soft soils and others. It will be the responsibility of the grading contractor to inform the project soils engineer of the presence of such prior to further site preparations and grading.
- (IV) In order to minimize potential for differential settlements, it is recommended that structural footings should be established exclusively into engineered fills of local soils compacted to the minimum as recommended in this report. Construction of footings and slabs straddling over cut/fill transitions shall be avoided.
- (V) Structural design consideration should include probability for "moderate" peak ground acceleration from relatively active nearby earthquake faults. Implementing the seismic design parameters and procedures as outlined in the current CBC and as described earlier, however, may minimize the adverse effects for the structures proposed.
- (VI) Although no shallow depth groundwater was encountered, provisions should be maintained during construction to divert incidental rainfall away from the structural pads constructed.
- (VII) It is our opinion that, if site preparations and grading are performed as recommended and as per the generally accepted construction practices and current CBC, the proposed development will not adversely affect the stability of the site or its adjacent.

4.1.1 Recommendations for Site Preparations and Grading for Structural Support

In absence of detailed development plans review, the planned structural pad grades are assumed at/or near the existing grade surface. For adequate structural support, it is our opinion that moderate site preparations and grading should be included in the form of subexcavations of the near grade dry, silty, gravelly, variable consistency soils and their replacement as engineered fills compacted to minimum 95%.

In general, site preparations and grading should include subexcavations of the near surface soils to minimum 5 feet below the current grade surface or to the depth as required to expose the underlying damp and dense natural subgrades or to the depth as required to maintain a 24-inch-thick compacted fill mat blanket below foundation bottoms, whichever is applicable, followed by the installation of a layer of biaxial geogrid such as Tensar BX1100 or approved equal overlain by a 2-foot-thick layer of clean 2 to 3-inch diameter crushed rocks or gravels.

The site preparations and grading described should encompass, at a minimum, the proposed structural footprint areas and minimum 5 feet beyond or as suggested by the geotechnical engineer during grading. No cut and fill transition conditions should be allowed.

Within areas requiring fill soils, if any, such may be placed following sufficient subexcavations to expose the underlying dense subgrades as approved by the project soils engineer. During grading, the engineered fills placed should be compacted to near Optimum Moisture Content and with minimum 95% compaction of soils' Maximum Dry Density as determined by the ASTM D1557 test method.

The subexcavation depths described should be considered as "preliminary". Localized additional subexcavations may be required within areas underlain by undocumented old fills, buried utilities, and abandoned sewer and/or buried septic systems. It is recommended that the excavated subgrades should be verified and approved by the soils engineer prior to structural fill soil placement. Supplemental recommendations may be warranted following detailed development plans review.

Mass grading required for the project is recommended to encompass, at a minimum, the entire individual structural pads and minimum 5 feet beyond.

No cut and fill transition conditions underneath foundations should be allowed.

For reference, supplemental general mass grading recommendations are included in Section 5.

4.1.2 Structural Fill Material Requirements

- (i) Non-expansive in nature, the on-site soils free of organics, debris, and rocks larger than 6-inch in diameter should be considered suitable for reuse as structural backfills.

Following mass grading completion, representative site soils sampled from graded fills expected in contact with footings and utilities should be laboratory tested to verify presence of sulfate, pH, chloride, and resistivity. Based on the chemical test results, supplemental design recommendations will be supplied prior to concrete pour. Such chemical testing will be scheduled upon request.

Import soils, if required, should be non-expansive, gravelly sand, and meeting the following criteria:

Liquid Limit	<35
Plasticity Index	<15
Expansion Index	<20

4.1.3 Cut and Fill Transition Pad Preparations (if applicable)

Use of cut and fill transitions should be avoided to minimize potentials for differential settlements to footings and concrete slab-on-grade. Within cut/fill transition areas, if becomes essential, it is suggested that following necessary cut, the entire structural pad should be prepared so as to establish a uniform bearing compacted fill mat prepared in conformance to the general guidelines as described below.

Pad Preparation Guidelines for Cut and Fill Transition Areas

Fill Depth Required for Finish Grade (Within low-lying areas)	Overexcavation Depth below Finish Grade (Within cut areas)
Up to 5 feet	Equal depth
5 to 10 feet	5 feet
Greater than 10 feet	One-half the maximum thickness of fills placed on the "fill" portion (20 feet maximum)

Cut portions should be overexcavated beyond the structural perimeter lines for a horizontal distance equal to the depth of overexcavation or to a minimum distance of 5 feet, whichever is greater. Actual subexcavation depths should be determined by the soils engineer during grading.

4.2 Structural Foundation Design Parameters

For structural support, it is assumed that for load bearing support conventional continuous wall foundations and isolated round/square footings will be used established into the engineered graded fills placed during site preparations and grading as described. Static structural loadings of 40 kips and 4 klf are assumed for isolated columns and continuous wall footings, respectively.

In absence of detailed development plans review, it is assumed that a one or two-story concrete framed, concrete block, and/or conventional wood frame and stucco construction with concrete slabs-on-grade will be constructed. In general, it is suggested that use of load bearing continuous wall and/or isolated spread footings will be used underlain by at least 24-inch-thick engineered fill mat blanket of local soils compacted to minimum 95%.

Under static loading conditions, with a Factor of Safety, $FS = 3.0$, an allowable soil vertical bearing capacity of 2500 psf may be considered in design. The soil bearing capacity described may be increased by 200 psf for each additional footing depth or width to a total not exceeding 4000 psf. If normal code requirements are applied, the above capacities may further be increased by an additional 1/3 for short duration of loading which includes the effect of wind and seismic forces.

From a geotechnical viewpoint, minimum 15-inch-wide x 18-inch-deep foundation dimensions may be considered for the planned structure. Actual foundation dimensions, including foundation thickness against punching shear etc., should be determined by the project structural engineer based on the static loading and seismic PGA described earlier.

The footing depths described should be measured vertically from the lowest adjacent outside grade and not from the finished pad grade or from finished floor surface. Footing depths and dimensions shall be verified by the soils engineer prior to footing-forming, rebar, and concrete placement. It will be the contractor's responsibility to arrange such verification by the soils engineer.

From a geotechnical viewpoint under static loading conditions, use of minimum reinforcements consisting of 2-#4 rebar placed near the top and 2-#4 rebar near bottom footings, are recommended. Additional reinforcements, if specified by the project structural engineer, should be incorporated in construction.

Based on the laboratory determined soils consolidation characteristics, settlements to properly designed and constructed foundations supported exclusively into engineered fills of site soils or its equivalent or better, and carrying maximum assumed structural loadings are expected to be within "tolerable" limits. Under static loading conditions, over a 40-foot-span, the estimated total and differential settlements should be about 1 and 1/2-inch, respectively, provided the foundations being supported by engineered fills of local soils compacted to minimum 95% as described. Most of the elastic deformations, however, are expected to occur during construction.

4.3 Concrete Slabs-on-Grade

No concrete slabs, sidewalks, and flatworks should be placed bearing directly on the surface soils currently existing. The prepared subgrades described to receive footings should be adequate for concrete slabs-on-grade placement. For estimation purposes, use of 4.5-inch-thick (net) concrete slab-on-grade is suggested for the building pad and 5-inch-thick (net) for truck parking/charging stalls reinforced with #3 rebar at 18-inch o/c. Actual slab-on-grade thickness, however, should be designed by the project structural engineer based upon structural loading, the seismic design parameters, and PGA described.

Within moisture sensitive areas, concrete slabs should be underlain by 2-inch of compacted clean sand, followed by 10-mil-thick vapor barrier, such as commercially available StegoWrap, Visqueen or other approved covering, overlying an additional 2-inch-thick layer of sands. Sands used should have a Sand Equivalent, SE of 30 or greater.

Building Pad/ Truck Parking/Truck Charging Stalls:

1. A 4.5-inch-thick (net) slab thickness for the building pad and 5-inch-thick (net) slab thickness for truck parking and truck charging stalls is suggested,
2. Use of 2500 psi concrete is suggested with maximum water/cement ratio of 0.64 or as suggested by the structural engineer,
3. Use of #3 rebar at 18-inch o/c using chairs or as required by the project structural engineer,
4. Within moisture sensitive areas, use of 10-mil-thick commercially available StegoWrap, Visqueen or other approved covering is recommended,
5. Use of a 2-inch layer of sand with SE greater than 30 over the installed Stego Wrap Visqueen or other approved covering is recommended,
6. Saw cut requirements shall be provided by the structural engineer.

Driveways:

1. A 5-inch-thick (net) slab is suggested bearing on local soils compacted to minimum 95%,
2. Use of #4 rebar at 18-inch o/c using chairs or as required by the project structural engineer,
3. Use of 2500 psi concrete is suggested with maximum water/cement ratio of 0.64 or as suggested by the structural engineer.

Flatwork:

1. A 3.5-inch-thick (net) concrete slab is suggested on local soils compacted to minimum 90%,
2. Use of 2500 psi concrete is suggested with maximum water/cement ratio of 0.64 or as suggested by the structural engineer,
3. Tooled joints per the structural engineer.

It is recommended that, prior to concrete pours, utility trenches underlying concrete slabs and driveways should be thoroughly backfilled with sandy gravelly soils, mechanically compacted to the minimum compaction requirements as described. No water jetting should be used in lieu of mechanically compaction.

Subgrades to receive concrete foundations and slabs-on-grade should be "dampened" as would be expected in any such concrete placement. Use of low-slump concrete is recommended. In addition, it is recommended that utility trenches underlying concrete slabs and driveways should be thoroughly backfilled with gravelly sandy soils mechanically compacted to minimum 90%. Concrete construction joint requirements should be determined by the project structural engineer.

To prevent concrete warping, no concrete should be placed during extreme weather conditions, such as during high outside temperatures and/or during high Santa Ana wind conditions.

4.3.1 Concrete Curing

In order to minimize potential for excessive concrete shrinkage or cracking, concrete slabs shall be adequately "cured" by using water or by using commercially available chemical curing agents.

4.4 Resistance to Lateral Loads

Resistance to foundation lateral displacement can be achieved by friction acting at the base of foundation and by passive earth pressures. A coefficient friction of 0.40 may be assumed with normal dead load forces for footing established on engineered compacted fills of local soils.

An allowable passive lateral earth resistance of 200 psf per foot of depth may be assumed for the sides of foundations poured against compacted fills. The maximum lateral passive earth pressure is recommended not to exceed 2000 lbs.

For design, active lateral pressures from local soils when used as backfills may be estimated from the following equivalent fluid density:

CONDITIONS	EQUIVALENT FLUID DENSITY, pcf	
	Level Backfill	2:1 Backfill Sloping Upwards
Active	30	40
At Rest	55	70
Seismic	20H (H=wall height)	20H (H=wall height)

4.5 Shrinkage and Subsidence

It is our opinion that during grading the upper soils may be subjected to a volume change. Assuming a 95% relative compaction for structural fills and assuming an overexcavation and recompaction depth as described earlier, such volume change due to shrinkage may be on the order of 8% to 10%. Further volume change may be expected due to supplemental shrinkage during preparation of subgrade soils. For estimation purpose, such may be approximated to about 2-inch when conventional construction equipment is used.

4.6 Soil Caving

Considering the dry silty sands, the site soils are susceptible to caving. Temporary excavations in excess of 4 feet should be made at a slope 2 to 1 (h:v) or flatter and as per the construction guidelines provided by Cal-Osha.

4.7 Construction Considerations

4.7.1 Unsupported Excavations

Dry silty sandy site soils encountered are considered highly susceptible to caving. Temporary excavations up to 4 feet in depth may be made without rigorous lateral supports. Excavated surface should be "wetted" during construction in order to minimize potential surface soil raveling. No surcharge loading should be allowed within an imaginary 1:1 line drawn upward from toe of temporary excavations.

4.7.2 Supported Excavations

If vertical excavations exceeding 4 feet in depth become warranted, such should be achieved using shoring to support sidewalls.

4.8 Structural Pavement Thickness

Alternative I – On Site Rigid Concrete Paving

Rigid paving, if selected, should be of at least 5-inch-thick (net) reinforced with #4 rebar at 18 inches o/c placed directly over the local engineered soils compacted to minimum 95%.

Actual paving thickness and reinforcement requirements, however, should be supplied by the project structural engineer using soils' Subgrade Reaction, k_{cf} of 250.

Rigid concrete driveways should have thickened edges to prevent potential for lateral sliding under auto and truck traffic loading.

Alternative II - Asphalt Paving

Flexible asphalt paving, if selected, based on the estimated Traffic Indices (TIs) as described below and an estimated soils' R-value of 55, the following flexible (a.c.) pavement sections are provided for estimation purposes:

Service Vehicle	Traffic Index, TIs	Pavement Type	Paving Thickness, inches
Auto/ Heavy-duty Truck Traffic	5.5-6.5	a.c. over Class II base or CMB	3.5 over 4.0
	6.5-7.5		4.0 over 4.5
	7.5+		5.0 over 5.0

Within paving areas, subgrade soils should be subexcavated to minimum 24 inches, moisture conditioned to near Optimum Moisture Content, followed by the excavated soils replacement as engineered fills compacted to at least 95% of the relative soils' Maximum Dry Density as determined by ASTM D1557 method. Class II base or CMB used to receive asphalt concrete should be placed directly over the prepared subgrades and compacted to minimum 95%. Use of deeper paving edges are recommended to minimize potential for edge movement and paving distress.

The pavement evaluations are based on estimated Traffic Indices (TIs) as shown and on the soils' R-value as described. It is recommended that following mass grading completion, representative site soils should be laboratory tested to determine soils' R-value and to provide updated paving thickness.

4.9 Retaining Wall (if planned)

Retaining walls, if planned, should be designed using the following equivalent active pressures in the form of fluid density:

Slope Surface of Retained Material (horizontal to vertical)	Equivalent Fluid	Density (pcf)
	Imported Clean Sand	Local Site Soils
Level	30	30
2:1	40	45

Retaining wall foundation design may be based on soils' vertical bearing capacity of 2000 psf for footing base materials compacted to minimum 90%.

The recommended lateral pressures do not include any surface surcharge load. Use of heavy equipment near retaining wall may develop lateral pressure in excess of the parameters described above. Installation of "French-drain" behind retaining walls is recommended to minimize water pressure build-up. Use of impervious material is preferred within the upper 18 inches of the wall backfills placed.

Backfill behind retaining wall should be compacted to a minimum 90% relative laboratory Maximum Dry Density as determined by the ASTM D1557 test method. Flooding and/or jetting behind wall should not be permitted. Local sandy soils may be used as backfill. Supplemental detailed retaining wall design and construction requirements will be supplied upon request.

4.10 Utility Trenches Backfills

Utility trenches backfills within structural pad areas and beyond should be placed in accordance with the following recommendations:

- o Trenches backfills consisting of flexible pipes should be placed in 6 to 8-inch thin lifts mechanically compacted to 90% or better of the laboratory maximum dry density for the soils used. Jetting is not recommended within utility trench backfill. Within streets, upper 2 feet of the trench backfill should be compacted to 90% or better.
- o Exterior trenches along a foundation or a toe of a slope and extending below a 1:1 imaginary line projected from the outside bottom edge of the footing or toe of the slope should be compacted to 90% of the Maximum Dry Density for the soils used during backfill. Excavations should conform to the requirements of Cal-Osha.

4.11 Seasonal Limitations

No fill shall be placed, spread or rolled during unfavorable weather conditions. Where the work is interrupted by heavy rains, fill operations shall not be resumed until moisture conditions are considered favorable by the soils engineer.

4.12 Planters

To minimize potential differential settlement to foundations, planters requiring heavy irrigation should be restricted from using adjacent to footings. In event such becomes unavoidable, planter boxes with sealed bottoms, should be considered.

4.13 Landscape Maintenance

Only the amount of irrigation necessary to sustain plant life should be provided. Pad drainage should be directed towards streets and to other approved areas away from foundations. Slope areas should be planted with draught resistant vegetation. Over watering landscape areas could adversely affect the proposed site development during its lifetime use.

4.14 Observations and Testing During Site Preparations and Grading

Recommendations provided assume that structural footings and slabs-on-grade be established exclusively into compacted fills. Excavated footings should be inspected, verified, and certified by the soils engineer prior to steel and concrete placement to ensure their sufficient embedment and proper bearing as recommended. Structural backfills discussed should be placed under direct observations and testing by Soils Southwest, Inc. Excess soils generated from footing excavations should be removed from pad areas.

In general, geotechnical inspections should include, at a minimum, the following:

- Subexcavation depth during grading,
- Fill compaction testing,
- Retaining wall backfill compaction,
- Excavated foundation depth,
- Paving subgrade verification, and
- Utility trenches backfill compaction.

4.15 Plan Review

No precise grading or detailed development plans are prepared and none such are available for review. Prior to the actual mass grading, grading and foundation plans should be available to ensure applicability of the assumptions made in preparing this report. If during construction, conditions are observed different from those as presented, revised and/or supplemental recommendations will be required.

4.16 Pre-Construction Meeting

It is recommended that no clearing of the site or any grading operations be performed without the presence of a representative of this office. An on-site pre-grading meeting should be arranged between the soils engineer and the grading contractor prior to the start of construction. Two days advance notice for such meeting is required.

5.0 Earth Work/General Grading Recommendations

The site soils primarily consist of upper loose to medium dense dry to damp silty fine to medium coarse sands varying in depth from approximately 3 to 5 feet below grade, overlying deposits of medium dense to dense gravely medium to coarse sands with pebbles, cobbles, and rocks to the maximum depth of 31 feet explored.

Prior to grading commencement, it is suggested that all debris and loose stockpiles should be cleared and disposed off-site to the satisfaction of the soils engineer. In general, site preparations and grading for the project should include, at a minimum, the following:

Structural Backfill

Local soils free of organic, debris, and rocks smaller than 6-inch in overall diameter should be considered suitable for reuse as structural backfill. Loose soils, formwork, and debris should be removed prior to backfilling retaining walls. Local soils backfill should be placed and compacted in accordance with the recommendations provided as below. Where space limitations do not allow conventional backfilling operations, special backfill materials, and procedures may be required. Pea gravel or other select backfill can be used within limited space areas. Additional recommendations on such will be provided during construction.

Percentage Compaction During Mass Grading

With the presence of silty fine to medium coarse gravelly sandy soils with isolated cobbles and rocks existing as described and assuming moderately high dead load and seismic peak ground acceleration described, it is our opinion that structural fills placed should be compacted to the minimum 95% compaction requirements described. During grading, use of vibratory sheepsfoot roller may be warranted.

Site Drainage

Adequate positive drainage should be maintained away from the structural pad in order to prevent water from ponding and to reduce potential percolation into backfill. A desirable slope for surface drainage is 2% in landscape areas and 1% in paved areas. Planters and landscaped areas adjacent to building perimeter should be adequately designed to minimize water filtration into subsoils. Considerations should be given to the use of closed planter bottoms, concrete slabs, and perimeter subdrains where applicable.

Utility Trenches

Buried utility conduits should be bedded and backfilled around the conduit in accordance with the project specifications. Buried utilities in excess of 2 feet should be backfilled with local gravelly sandy soils and compacted to at least 95%. Remaining near surface backfills should be compacted to 90%.

General Grading Recommendations:

Recommended general specifications for surface preparation to receive fill and compaction for structural and utility trench backfill and others are presented below.

1. Areas to be graded, backfilled or paved, shall be grubbed, stripped and cleaned of all buried and undetected debris, structures, concrete, vegetation and other deleterious materials prior to grading.
2. Where compacted fill is to provide vertical support for foundations, all loose, soft, and other incompetent soils should be removed to full depth as approved by the soils engineer, or at least up to the depth as previously described in this report. The areas of such removal should extend at least 5 feet beyond the perimeter of exterior foundation limit or to the extent as approved by the soils engineer during grading.

3. The fills to support foundations and slab-on-grade should be compacted to minimum 90% of the soils' Maximum Dry Density at near Optimum Moisture Conditions. To minimize potential differential settlements to foundations and slabs straddling over cut and fill transition, cut portions following cut, should be further over-excavated and such be replaced as engineered fill compacted to minimum percentage compaction requirements described.
4. Utility trenches within building pad areas and beyond should be backfilled with granular material and such should be mechanically compacted as described earlier.
5. Compaction for structural fills shall be determined relative to the Maximum Dry Density as determined by ASTM D1557 compaction methods. In-situ field density should be determined by the ASTM D1556 (Sand Cone standard method) or by other approved procedures.
6. Imported soils, if required, shall be clean, granular, and non-expansive in nature and as approved by the project soils engineer.
7. During grading, fill soils shall be placed in thin layers, thickness such should not exceed 6 to 8 inches.
8. No rocks over 6 to 8 inches in diameter shall be permitted to use as grading material without prior approval of the soils engineer.
9. No jetting and/or water tampering be considered for backfill compaction for utility trenches without prior approval of the soils engineer. For such backfill, hand tampering with fill layers of 8 to 12 inches in thickness is recommended.
10. The presence of any utility trenches at depth, cesspools or abandoned septic tanks existing within building pad areas and beyond, should be excavated and removed or such should be backfilled with gravel, slurry or by other material as approved by the soils engineer.
11. Imported fill soils, if required, should be equivalent to site soils or better. Such should be approved by the soils engineer prior to their use.
12. Grading required for pavement, sidewalks, or other facilities to be used by general public, should be constructed under direct observation of the soils engineer or as required by the local public agencies.
13. A site meeting should be held between the grading contractor and the soils engineer prior to actual construction. Two days advance notice will be required for such meeting.

6.0 WQMP-BMP Infiltration Rates Using Porchet Method for Stormwater Disposal System Design

Presented herewith are the preliminary results of soils infiltration testing as performed for the on-site storm water disposal design as proposed.

Two (2) infiltration tests were performed at about twelve (12) feet below the current grades for underground stormwater chamber locations P-1 and P-2 as selected by the project design engineer. The evaluations are made using the standardized "falling-head" test method, converted to soil infiltration rates using the Porchet Method as per the guidelines as described in Table 1, Infiltration Basin Option 2 of Appendix A of the Riverside County-Low Impact Development (LID) BMP design Handbook, as well as the Appendices Section VII.3.8.2, Appendix VII: Infiltration Rate Evaluation Protocol and Factor of Safety Recommendations of the San Bernardino County Technical Guidance Document for Water Quality Management Plan Handbook. Approximate test locations, P-1 and P-2 are shown on the attached Plate 1.

The soils encountered consist, in general, of upper fine to medium slightly silty sands overlying fine to medium coarse sands and gravels consisting of pebbles, cobbles, rock fragments, and rocks. For determining the presence of shallow depth groundwater or impermeable layer, supplemental foundation test explorations were advanced to the depth of thirty-one (31) feet below grade adjacent to the infiltration test borings. Based on such, no free groundwater or impermeable soils layers were encountered.

Based on the soil infiltration testing completed in the field, the observed soils' infiltration rates are 7.40-inch/hour and 6.81-inch/hour for the described BMP test locations, P-1 and P-2, respectively. For design, use of an appropriate safety factor should be considered to the observed rates as selected by the project design engineer.

6.1 EXCAVATED TEST BORINGS

The BMP test borings (P-1 and P-2) were made using an 8-inch diameter hollow-stem auger drilling rig, advanced to approximately 12 feet below the current grade. Water used during infiltration testing was supplied by using a portable water tank.

6.2 METHODOLOGY AND TEST PROCEDURES

EQUIPMENT SET-UP (POST EXCAVATION) PROCEDURES:

Following test boring completion each of the test holes were fitted with perforated PVC pipes, backfilled with 2-inch-thick crushed rock at the bottom to minimize potentials for scouring and caving. To determine test intervals, as per the Section 2.3 for deep percolation testing of the referenced handbook guideline, two consecutive readings were initially made to determine if 6 inches or more of water seeped in 25 minutes. Since 6 inches or more of water seeped away in less than 25 minutes for tests P-1 and P-2, subsequent percolation testing was performed at 10-minute time intervals for minimum 1 hours or until the soil percolation rates were consistent.

The 10-minute recorded percolation tests' rate were converted into an Infiltration Rate (I_t) in inches/hour using the "Porchet Method" equation as described in the Reference 2, Riverside County Low Impact Development BMP Design Handbook.

6.3 INFILTRATION TEST RESULTS

Based on the soil infiltration testing completed at the test locations and at the test depth as described, the observed soils' percolation rates are 7.40-inch/hour and 6.81-inch/hour for test locations P-1 and P-2, respectively.

Calculations to convert the percolation test rate to infiltration test rates in accordance with Section 2.3 of the County Handbook are presented in Table I and II below. For design, it is suggested that an appropriate Factor of Safety as selected by the design engineer should be considered to the observed field percolation rate described.

6.3.1 CONVERSION CALCULATIONS & SUMMARY:

TABLE I
Summary of Observed Infiltration Rates

Test Date (9-21-22) & Test No.	Test Depth Below Grade (ft)	Change in Water Level (in)	Observed Rate Using Porchet Method (in/hr)
P-1	10.0	12.25	7.40
P-2	10.0	11.5	6.81

TABLE II
Conversion Table (Porchet Method)

Test No.	Test Hole Depth,	Time Interval,	Initial Depth,	Final Depth,	Initial Water Height, (in)	Final Water Height, (in)	Change in Water Height (in)	Average Head Height (in)
	D_T (in)	Δt (min)	D_O (in)	D_f (in)	$H_O = D_T - D_O$	$H_f = D_T - D_f$	$\Delta H = H_O - H_f$	$H_{avg} = (H_O + H_f) / 2$
P-1	144	10	120	132.25	24	11.75	12.25	17.875
P-2	144	10	120	131.5	24	12.5	11.5	18.25

Test No.	Infiltration Rate ($I_t = \Delta H 60r / \Delta t (r + 2H_{avg})$)		
	A	B	C
	$\Delta H 60r$	$\Delta t (r + 2H_{avg})$	A/B = in/hr
P-1	2940	397.5	7.40
P-2	2760	405	6.81

The infiltration rates described are based on the in-situ testing completed at the locations and to the depths as suggested by the project civil engineer. In event the final chamber locations or chamber depths vary considerably from those as described herein, supplemental soils infiltration testing may be warranted.

It should be noted that over prolong use and lack of maintenance the detention/infiltration basins or deep chambers constructed based on the suggested design rates may experience much lower infiltration rates due to the accumulation of silts, fines, oils, and others. Regular maintenance of the chambers in form of removal of debris, oil and fines are strongly recommended. A maintenance record of such is suggested.

We offer no other warranty, express or implied.

Suggested Requirements for Standard Stormwater BMP installation:

The invert of stormwater infiltration should be set at least 10 feet above the groundwater elevation and should not be placed on steep slopes to create conditions for slopes instability.

When adequately installed, it is our opinion that the Stormwater infiltration systems installed should not increase the potentials for static or seismic settlement of structures.

Stormwater infiltration installed should not place an increased surcharge on structures or foundations on or its adjacent. The pore water pressure should not increase the soils retained by retaining structures.

The invert of stormwater infiltration should be set back at least 15 feet and outside a 1:1 plan drawn up from the bottom of adjacent foundations.

Stormwater infiltration should not be located near utility lines where the introduction of stormwater could cause damage to utilities or settlement of trench backfill.

Stormwater infiltration systems should not be allowed within 100 feet of any potable groundwater production well.

Once installed, regular maintenance of the detention system is recommended.

7.0 Closure

The opinions and conclusions presented are based upon the findings and observations as made during subsurface test excavations and subsequent laboratory testing and engineering evaluations as currently used in the Geotechnical industry. The recommendations supplied should be considered "preliminary" since they are based on soil samples only. If during construction, the subsoil conditions appear different from those as disclosed during field investigation this office should be notified to consider any possible need for modification by the geotechnical recommendations as provided in this report.

Recommendations provided are based on the assumptions that structural footings strictly be established exclusively into compacted fill. No footings and/or slabs should be allowed straddling over cut/fill transition interface.

Site grading observations and testing must be performed by a representative of this office. Further, it is recommended that excavated footings should be verified and approved by soils engineer prior to steel and concrete placement to ensure that foundations are founded into satisfactory soils and excavations are free of loose and disturbed materials.

A pre-grading meeting in between grading contractor and soils engineer is recommended prior to construction preferably at the site, to discuss the grading procedures to be implemented and other requirements described in this report to be fulfilled.

This report has been prepared exclusively for the use of the addressee for the project referenced in the context. It shall not be transferred or be used by other parties without a written consent by Soils Southwest, Inc.

Should the project be delayed beyond one year after the date of this report, the recommendations presented shall be reviewed to consider any possible change in site conditions.

The recommendations presented are on the assumption that the necessary geotechnical observations and testing during construction will be performed by a representative of this office. The field observations are considered a continuation of the geotechnical investigation performed.

If another firm is retained for geotechnical observations and testing, our professional liability and responsibility shall be limited to the extent that Soils Southwest, Inc. would not be the geotechnical engineer of record. Use of the geotechnical recommendations by others will relieve Soils Southwest, Inc. of any liability that may arise during the lifetime use of the structure constructed.

PLOT PLAN AND TEST LOCATIONS
Planned EV Truck Leasing Service Facility
1380 S. E Street
San Bernardino, California
APN: 0141-252-08

NTS

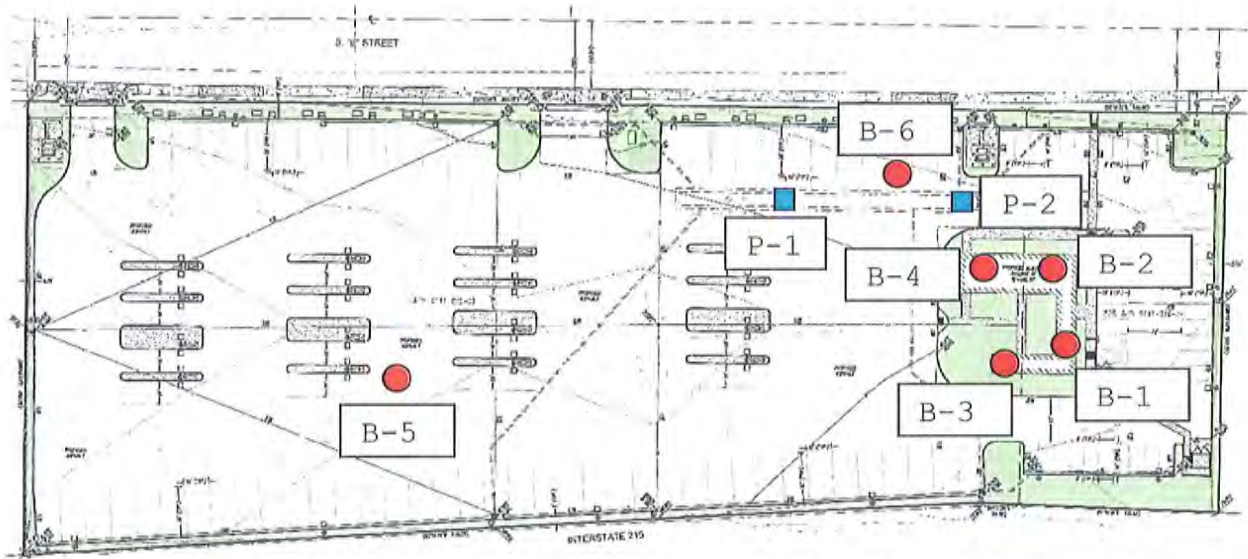

- Legend:
- B-1 Approximate Location of Test Borings for Geotechnical Study
 - P-1 Approximate Location of Test Boring for BMP Soils' Infiltration
- Plate 1

List of Appendices

Appendix A - Log of Borings

Appendix B - Laboratory Test Results

- Table I: Moisture-Density Determinations (ASTM D2216)
- Table II: Maximum Density/Optimum Moisture Content (ASTM D1557)
- Table III: Direct Shear (ASTM D3080)
- Table IV: Consolidation (D2435)
- Table V: Sand Equivalent, SE (ASTM D2419)
- Table VI: Sieve Analysis (ASTM D422)
- Table VII: Soil Density Correlation to SPT Blow Counts

APPENDIX C - Supplemental Seismic Design Parameters, Liquefaction Analyses, and FEMA National Flood Hazard FIRMette Layer Map

APPENDIX D - Soil Infiltration Test Data Porchet Method Calculation Summary

APPENDIX A

Field Explorations

Geotechnical evaluations included 6 exploratory test borings (B-1 to B-6) using a hollow-stem auger drilling rig advanced to maximum depth of 31 feet below grade, along with 2 test borings (P-1 and P-2) to a maximum depth of 12 feet below the existing the grade surface. Approximate test exploration locations are shown on the attached Plate 1.

Soils encountered during explorations were logged and such were classified by visual observations in accordance with the generally accepted classification system. The field descriptions were modified, where appropriate, to reflect laboratory test results. The bulk and undisturbed soil samples procured were sent to our laboratory for geotechnical analyses as described in the attached Log of Borings.

The Log of Borings is presented in the following summary sheets that include the description of the soils and/or fill materials encountered.

LOG OF BORINGS



Soils Southwest, Inc.
 897 Via Lata, Suite N
 Colton, CA 92324
 (909) 370-0474 Fax (909) 370-3156

LOG OF BORING B-1

Project: Watt EV/Truck Leasing Facility **Job No.:** 22051-F/BMP
Logged By: Marco C. **Boring Diam.:** 6" HSA **Date:** October 15, 2022

Standard Penetration (Blows per Ft.)	Sample Type	Water Content in %	Dry Density in PCF	Percent Compaction	Unified Classification System	Graphic	Depth in Feet	Description and Remarks
31	█				SM		5	tilled weeds SAND - light gray-brown, silty, slightly gravelly, fine to medium coarse, scattered pebbles, dry - (Max Dry Density = 125 pcf @ 10 %)
16	█	14	113	90.4	SP		10	- color change to brown, silty, fine to, medium to coarse with pebbles, rocks, cobbles
10	█				SM		15	- color change to dark gray, silty, fine, moist
28	█	3.8	96.1	76.8	SP		20	- color change to yellow, traces of silts, fine to medium coarse
42	█				SM		25	- color change to dark greenish gray to dark gray, silty, fine to medium, damp
44	█				GP-SP		30	- color change to light tannish brown, gravelly, coarse, rock fragments and scattered rock 1 1/2", dry
								- End of test boring @ 31.0 ft. - no bedrock - no groundwater

Groundwater: n/a Approx. Depth of Bedrock: n/a Datum: n/a Elevation: n/a	Site Location Proposed EV Truck Leasing Facility 1380 S. E Street San Bernardino, California	Plate #
---	--	----------------

Standard penetration test
 Bulk/Grab sample
 California sampler



Soils Southwest, Inc.
 897 Via Lata, Suite N
 Colton, CA 92324
 (909) 370-0474 Fax (909) 370-3156

LOG OF BORING B-2

Project: Watt EV/Truck Leasing Facility	Job No.: 22051-F/BMP
Logged By: Marco C.	Boring Diam.: 6" HSA
Date: October 15, 2022	

Standard Penetration (Blows per Ft.)	Sample Type	Water Content in %	Dry Density in PCF	Percent Compaction	Unified Classification System	Graphic	Depth in Feet	Description and Remarks
					SM			tilled weeds
35	2.5	117.2	93.75		SP		5	SAND - yellowish tannish brown, silty, fine to medium, dry
20								- color change to tan, traces of silt, gravelly, medium to coarse, pebbles, rock fragments rocks 1-1/2", dense, dry
7.0	14	92.8	74.27		SM		10	- medium dense
								- color change to tan, silty, fine to medium pebbles, scat rocks and cobbles, loose, damp to moist
					GP-SP		15	- gravely, coarse, rocks up to 2"
37								- dense
							20	- color change to light brown, gravelly, coarse, dry
								- End of test boring @ 20 ft.
								- no bedrock
								- no groundwater
							25	
							30	

Groundwater: n/a	Site Location Proposed EV Truck Leasing Facility 1380 S. E Street San Bernardino, California	Plate #
Approx. Depth of Bedrock: n/a		
Datum: n/a		
Elevation: n/a		

Standard penetration test
 Bulk/Grab sample
 California sampler



Soils Southwest, Inc.
 897 Via Lata, Suite N
 Colton, CA 92324
 (909) 370-0474 Fax (909) 370-3156

LOG OF BORING B-3

Project: Watt EV/Truck Leasing Facility **Job No.:** 22051-F/BMP
Logged By: Marco C. **Boring Diam.:** 6" HSA **Date:** October 15, 2022

Standard Penetration (Blows per Ft.)	Sample Type	Water Content in %	Dry Density in PCF	Percent Compaction	Unified Classification System	Graphic	Depth in Feet	Description and Remarks
13	▲				SP		5	tilled weeds SAND - light gray to light brown, fine to medium coarse, rocks, dry
7.0	■	17	81.8	65.4	GP-SP		10	- color change to yellowish tan brown, gravelly, coarse, low density
					SM		15	- color change to dark gray to black, silty fine to medium, pebbles, rock fragments moist, loose
30	▲				GP-SP		20	- color change to light brown, gravelly, coarse, dry - dense
							25	- End of test boring @ 16.0 ft. - no bedrock - no groundwater
							30	

Groundwater: n/a Approx. Depth of Bedrock: n/a Datum: n/a Elevation: n/a	Site Location Proposed EV Truck Leasing Facility 1380 S. E Street San Bernardino, California	Plate #
---	--	----------------

Standard penetration test
 Bulk/Grab sample
 California sampler



Soils Southwest, Inc.
 897 Via Lata, Suite N
 Colton, CA 92324
 (909) 370-0474 Fax (909) 370-3156

LOG OF BORING B-4

Project: Watt EV/Truck Leasing Facility **Job No.:** 22051-F/BMP
Logged By: Marco C. **Boring Diam.:** 6" HSA **Date:** October 15, 2022

Standard Penetration Penetration (Blows per Ft.)	Sample Type	Water Content in %	Dry Density in PCF	Percent Compaction	Unified Classification System	Graphic	Depth in Feet	Description and Remarks
5					SM		5	tilled weeds SAND - light yellowish tannish brown, silty, fine to medium, traces of gravels
30		125	102.1	81.6	GP-SP		10	- color change to light brown, gravelly, traces of silt, coarse, pebbles, rock fragments, rocks 1"
40					SM-ML		15	- color change to light gray brown, silty, fine, scattered pebbles
36					GP-SP		20	- gravelly, very coarse, rocks and cobbles - dense
							25	- End of test boring @ 21.0 ft. - no bedrock - no groundwater
							30	

Groundwater: n/a Approx. Depth of Bedrock: n/a Datum: n/a Elevation: n/a	Site Location Proposed EV Truck Leasing Facility 1380 S. E Street San Bernardino, California	Plate #
---	--	----------------



Soils Southwest, Inc.
 897 Via Lata, Suite N
 Colton, CA 92324
 (909) 370-0474 Fax (909) 370-3156

LOG OF BORING BMP P-1

Project: Watt EV/Truck Leasing Facility **Job No.:** 22051-F/BMP
Logged By: Marco C. **Boring Diam.:** 6" HSA **Date:** October 15, 2022

Standard Penetration (Blows per Ft.)	Sample Type	Water Content in %	Dry Density in PCF	Percent Compaction	Unified Classification System	Graphic	Depth in Feet	Description and Remarks
					SM			tilled weeds SAND - dark gray to brown, silty, fine to medium coarse, pebbles
					SP		5	- color change to light brown, slightly gravelly, fine to medium coarse
					SP-SM		10	- color change to brown, slightly silty, gravelly, fine to medium coarse, pebbles, rock fragments, rocks, and scattered cobbles
					GM-SM			- silty, gravelly, fine to coarse
							15	- End of infiltration test boring @ 12 ft. - no bedrock - no groundwater - 3" socked perforated PVC pipe installed with gravel at bottom
							20	
							25	
							30	

Groundwater: n/a Approx. Depth of Bedrock: n/a Datum: n/a Elevation: n/a	Site Location Proposed EV Truck Leasing Facility 1380 S. E Street San Bernardino, California	Plate #
---	--	----------------



Soils Southwest, Inc.
 897 Via Lata, Suite N
 Colton, CA 92324
 (909) 370-0474 Fax (909) 370-3156

LOG OF BORING BMP P-2

Project: Watt EV/Truck Leasing Facility	Job No.: 22051-F/BMP
Logged By: Marco C.	Boring Diam.: 6" HSA
Date: October 15, 2022	

Standard Penetration (Blows per Ft.)	Sample Type	Water Content in %	Dry Density in PCF	Percent Compaction	Unified Classification System	Graphic	Depth in Feet	Description and Remarks
					SM		5	tilled weeds SAND - gray to brown, silty, fine to medium coarse, pebbles
					GM-SM		10	- color change to light brown, slightly silty, gravelly, fine to medium coarse, pebbles, rock fragments
							15	- End of infiltration test boring @ 12 ft. - no bedrock - no groundwater - 3" socked perforated PVC pipe installed with gravel at bottom
							20	
							25	
							30	

Groundwater: n/a	Site Location Proposed EV Truck Leasing Facility 1380 S. E Street San Bernardino, California	Plate #
Approx. Depth of Bedrock: n/a		
Datum: n/a		
Elevation: n/a		



Soils Southwest, Inc.
 897 Via Lata, Suite N
 Colton, CA 92324
 (909) 370-0474 Fax (909) 370-3156

LOG OF BORING PAVING B-5

Project: Watt EV/Truck Leasing Facility **Job No.:** 22051-F/BMP
Logged By: Marco C. **Boring Diam.:** 6" HSA **Date:** October 15, 2022

Standard Penetration (Blows per Ft.)	Sample Type	Water Content in %	Dry Density in PCF	Percent Compaction	Unified Classification System	Graphic	Depth in Feet	Description and Remarks
					GP-SP			tilled weeds
								SAND - light gray brown, traces of silt, gravely, fine to coarse, pebbles, rock fragments, rocks
							5	- End of test boring @ 3.0 ft. - no bedrock - no groundwater
							10	
							15	
							20	
							25	
							30	

Groundwater: n/a Approx. Depth of Bedrock: n/a Datum: n/a Elevation: n/a	Site Location Proposed EV Truck Leasing Facility 1380 S. E Street San Bernardino, California	Plate #
---	--	----------------

Bulk/Grab sample



Soils Southwest, Inc.
 897 Via Lata, Suite N
 Colton, CA 92324
 (909) 370-0474 Fax (909) 370-3156

LOG OF BORING PAVING B-6

Project: Watt EV/Truck Leasing Facility **Job No.:** 22051-F/BMP
Logged By: Marco C. **Boring Diam.:** 6" HSA **Date:** October 15, 2022

Standard Penetration (Blows per Ft.)	Sample Type	Water Content in %	Dry Density in PCF	Percent Compaction	Unified Classification System	Graphic	Depth in Feet	Description and Remarks
					SM			tilled weeds
								SAND - light gray, silty, fine to medium, occasional pebbles, scattered rock fragments
							5	- End of test boring @ 3.0 ft. - no bedrock - no groundwater
							10	
							15	
							20	
							25	
							30	

Groundwater: n/a Approx. Depth of Bedrock: n/a Datum: n/a Elevation: n/a	Site Location Proposed EV Truck Leasing Facility 1380 S. E Street San Bernardino, California	Plate #
---	--	----------------

Bulk/Grab sample

KEY TO SYMBOLS

Symbol Description

Strata symbols



Silty sand



Poorly graded sand



Poorly graded gravel
and sand



Poorly graded silty
fine sand



Poorly graded sand
with silt



Silty sand and gravel

Soil Samplers



Standard penetration test



Bulk/Grab sample



California sampler

Notes:

1. Exploratory borings were drilled on October 15, 2022 using a 4-inch diameter continuous flight power auger.
2. No free water was encountered at the time of drilling or when re-checked the following day.
3. Boring locations were taped from existing features and elevations extrapolated from the final design schematic plan.
4. These logs are subject to the limitations, conclusions, and recommendations in this report.
5. Results of tests conducted on samples recovered are reported on the logs.



Soils Southwest, Inc.
 897 Via Lata, Suite N
 Colton, CA 92324
 (909) 370-0474 Fax (909) 370-3156

LOG OF BORING B-1b

Project: Watt EV/Truck Leasing Facility **Job No.:** 22051-F/BMP
Logged By: Marco C. **Boring Diam.:** 6" HSA **Date:** October 15, 2022

Standard Penetration (Blows per Ft.)	Sample Type	Water Content in %	Dry Density in PCF	Percent Compaction	Unified Classification System	Graphic	Depth in Feet	Description and Remarks
31	█	14	113	90.4	SM		5	tilled weeds SAND - light gray-brown, silty, slightly gravelly, fine to medium coarse, scattered pebbles, dry - (Max Dry Density = 125 pcf @ 10 %)
16	█						10	- color change to brown, silty, fine to, medium to coarse with pebbles, rocks, cobbles
10	█				SM		15	- color change to dark gray, silty, fine, moist
28	█	3.8	96.1	76.8	SP		20	- color change to yellow, traces of silts, fine to medium coarse - color change to dark greenish gray to dark gray, silty, fine to medium, damp
42	█						25	- color change to light tannish brown, gravelly, coarse, rock fragments and scattered rock 1 1/2", dry
44	█				GP-SP		30	- color change to dark gray brown, gravelly, medium coarse to coarse, pebbles, rock fragments

Groundwater: n/a Approx. Depth of Bedrock: n/a Datum: n/a Elevation: n/a	Site Location Proposed EV Truck Leasing Facility 1380 S. E Street San Bernardino, California	Plate #
---	--	----------------

Standard penetration test
 Bulk/Grab sample
 California sampler



Soils Southwest, Inc.
 897 Via Lata, Suite N
 Colton, CA 92324
 (909) 370-0474 Fax (909) 370-3156

LOG OF BORING B-1b

Project: Watt EV/Truck Leasing Facility	Job No.: 22051-F/BMP
Logged By: Marco C.	Boring Diam.: 6" HSA
Date: October 15, 2022	

Standard Penetration (Blows per Ft.)	Sample Type	Water Content in %	Dry Density in PCF	Percent Compaction	Unified Classification System	Graphic	Depth in Feet	Description and Remarks
48							40	
							45	
35					SM SP		50	- color change to light brown, silty, fine, moist
								- color change to light gray, fine to medium pebbles, scattered rock fragments, dense, dr
								- End of test boring @ 51.0 ft.
							55	- no bedrock - no groundwater
							60	
							65	
							70	

APPENDIX B

Laboratory Test Programs

Laboratory tests were conducted on representative soils for the purpose of classification and for the determination of the physical properties and engineering characteristics. The number and selection of the types of testing for a given study are based on the geotechnical conditions of the site. A summary of the various laboratory tests performed for the project is presented below.

Moisture Content and Dry Density (ASTM D2216-80):

Data obtained from these tests performed on undisturbed samples are used to aid in geotechnical soil classification and correlation of the soils and to provide qualitative information regarding in-situ soil strengths.

Direct Shear (ASTM D3080):

Data obtained from this test performed at increased and field moisture conditions on relatively undisturbed and remolded soil sample is used to evaluate soil shear strengths. Samples contained in brass sampler rings placed directly on test apparatus are sheared at a constant strain rate of 0.002 inch per minute under saturated conditions and under varying loads appropriate to represent anticipated structural loadings. Shearing deformations are recorded to failure. Peak and/or residual shear strengths are obtained from the measured shearing load versus deflection curve. Test results, plotted in graphical form, are presented on Plate B-1 of this section.

Soil Consolidation (ASTM D2835):

Drive-tube samples are tested at their field moisture contents and at increased moisture conditions since the soils may become saturated during lifetime use of the planned structure.

Data obtained from this test performed on relatively undisturbed and/or remolded samples, were used to evaluate the consolidation characteristics of foundation soils under anticipated foundation loadings. Preparation for this test involved trimming the sample, placing it in 1-inch-high brass ring, and loading it into the test apparatus which contained porous stones to accommodate drainage during testing. Normal axial loads are applied at a load increment ratio, successive loads being generally twice the preceding.

Soil samples are usually under light normal load conditions to accommodate seating of the apparatus. Samples were tested at the field moisture conditions at a predetermined normal load. Potentially moisture sensitive soil typically demonstrated significant volume change with the introduction of free water. The results of the consolidation tests are presented in graphical forms on Plate B-2 of this section.

Sieve Analysis (ASTM D422):

Soils gradation analyses are performed on procured bulk samples at various testing for depths to determine the classification of existing soil conditions.

Laboratory Test Results

Table I: Maximum Dry Density - Optimum Moisture Content (ASTM D1557)

Boring No. @ Sample Depth, ft	Max. Dry Density, pcf	Optimum Moisture Content, %
B-1 @ 3-5 SM SAND- light brown, silty, fine to medium coarse with pebbles, rock fragments, and scattered rocks up to 2-in in diameter	125	10.0

Table II: In-Situ Moisture-Density Determinations (ASTM D2216)

Test Boring No.	Sample Depth, ft	Dry Density, pcf	Moisture Content, %
B-1	5	113.0	13.68
B-1	15	96.05	3.84
B-2	3	117.19	2.46
B-2	8	92.84	13.68
B-3	8	81.78	17.39
B-4	8	102.05	12.5

Table III: Direct Shear (ASTM D3080)

Test Trench or Boring @ Sample Depth, ft	Test Condition	Cohesion, pdf	Friction, degrees
B-1 @ 3-5	Remolded to 90%	425.31	42.83
B-1 @ 5	Undisturbed	225.45	49.78
B-2 @ 8	Remolded to 90%	300.22	45.36

Table IV: Consolidation (D2435)

Sample #	Depth, ft	Consolidation prior to saturation, % @ 2 kips	Hydro Collapse, % @ 2 kips	Total Consolidation, % @ 8 kips (saturated)
B-1 (remolded)	3-5	0.6	0.1	1.6
B-1 (undisturbed)	5	0.5	0.1	1.7
B-4 (undisturbed)	8	0.5	0.1	3.2

Table V: Sand Equivalent, SE (ASTM D2419)

Sample Location @ depth, feet	Sand Equivalent, SE
B-5 @ 1-3	29.41
B-6 @ 1-3	7.78

Table VI: Sieve Analysis (ASTM D422)

SAMPLE: B-5 @ 1-3 feet

Grain Size	% Retained
Gravels	11
Medium to Coarse	43
Fines	38
Silts	8

Table VII: Soil Density Correlation to SPT Blow Counts

Density/Consistency		1" Soil Tube -- Blows Per Foot			Standard Penetration Blows Per Foot
Granular	Cohesive	Sand and Gravel	Silt	Clay	
Very Loose	Very Soft	0-50	0-50	0-60	0-5
Loose	Soft	50-100	50-180	60-250	5-10
Slightly Compact	Stiff	100-350	180-1000	250-1000	10-20
Compact	Very Stiff	350-525	1000-2000	1000-4000	20-35
Dense	Hard	525-1500	2000-5000	4000-5000	35-70
Very Dense	Very Hard	1500+	5000+	5000+	70+

MODIFIED PROCTOR COMPACTION TEST (ASTM STD. 1557)

MOISTURE % (g)	3.84	10.00	13.68	13.68
DRY DENSITY (pcf)	118.74	125	118.22	118.22

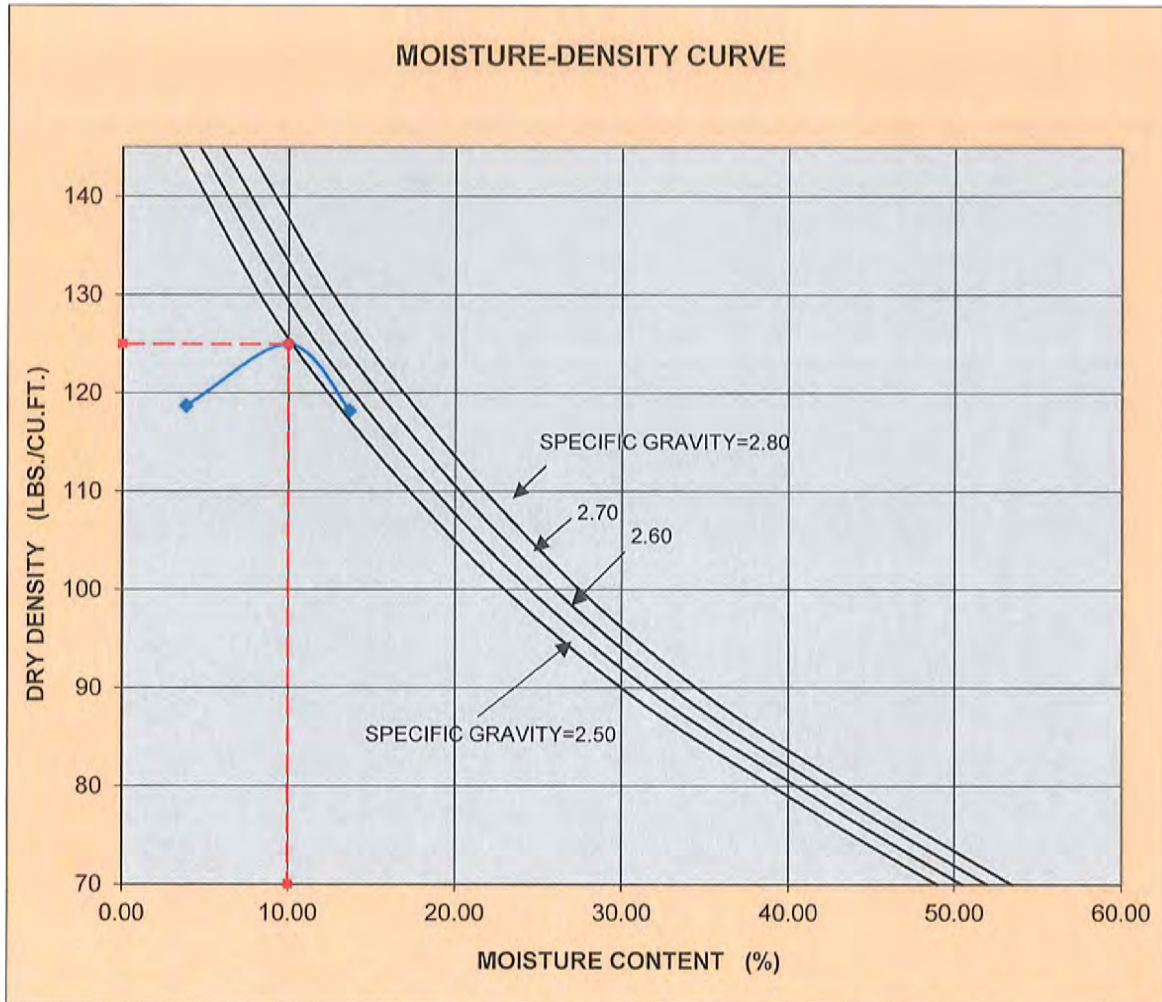

CURVE NO.	SOIL DESCRIPTION	OPT MOIST. CONTENT(%)	MAX DRY DENSITY (P.C.F.)
B-1 3-5'	Watt Ev, Inc. Truck Leasing Facility 1380 S. "E" Street c/s Century Ave. San Bernardino, California	10	125
SOIL DESCRIPTION: SM- SAND - light brown, silty, fine to medium, pebbles, rock fragments, scattered rocks up to 2"			PROJECT NO. 22051-F PLATE: A-1

SOILS SOUTHWEST INC.
Consulting Foundation Engineers

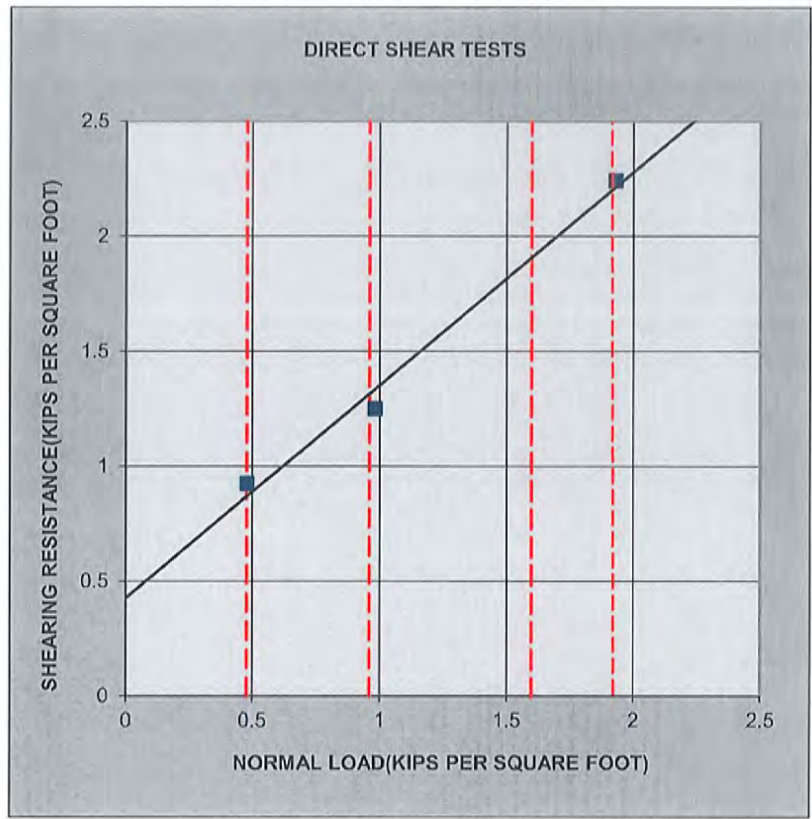

SYMBOL	LOCATION	DEPTH (FT)	TEST CONDITION	COHESION (psf)	FRICTION (degree)
■	B-1	3 to 5	Remolded to 90%	425.31	42.83
Proposed EV Truck Leasing Facility 1380 South E Street San Bernardino, California				PROJECT NO.	22051-F
				PLATE	B-1



SOILS SOUTHWEST, INC.
Consulting Foundation Engineers

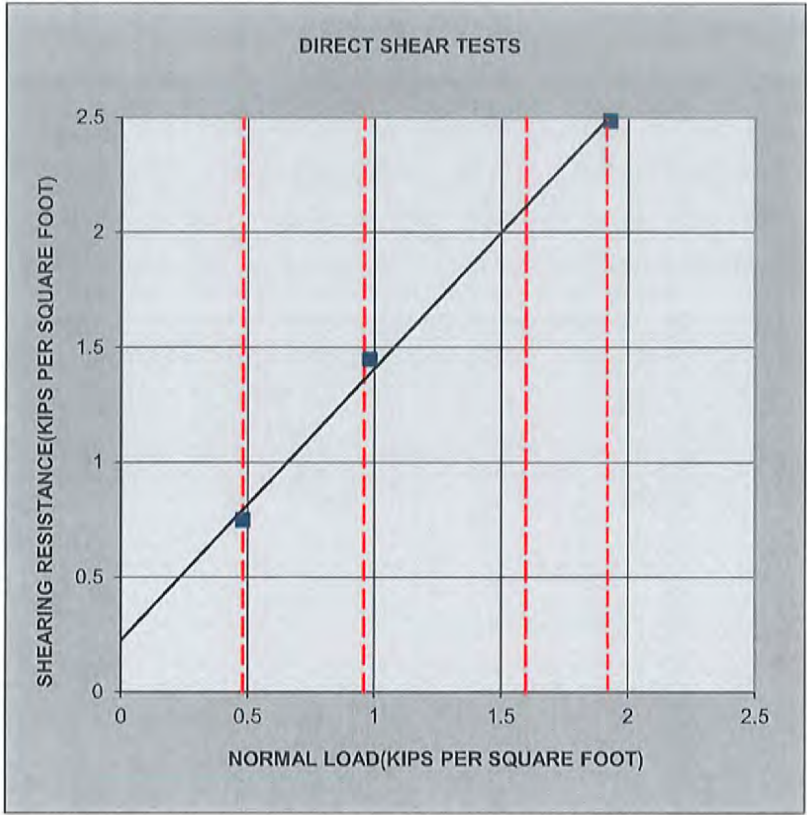

SYMBOL	LOCATION	DEPTH (FT)	TEST CONDITION	COHESION (psf)	FRICTION (degree)
■	B-1	5.0	Undisturbed	225.45	49.78
Proposed EV Truck Leasing Facility 1380 South E Street San Bernardino, California				PROJECT NO.	22051-F
				PLATE	B-1-1



SOILS SOUTHWEST, INC.
Consulting Foundation Engineers

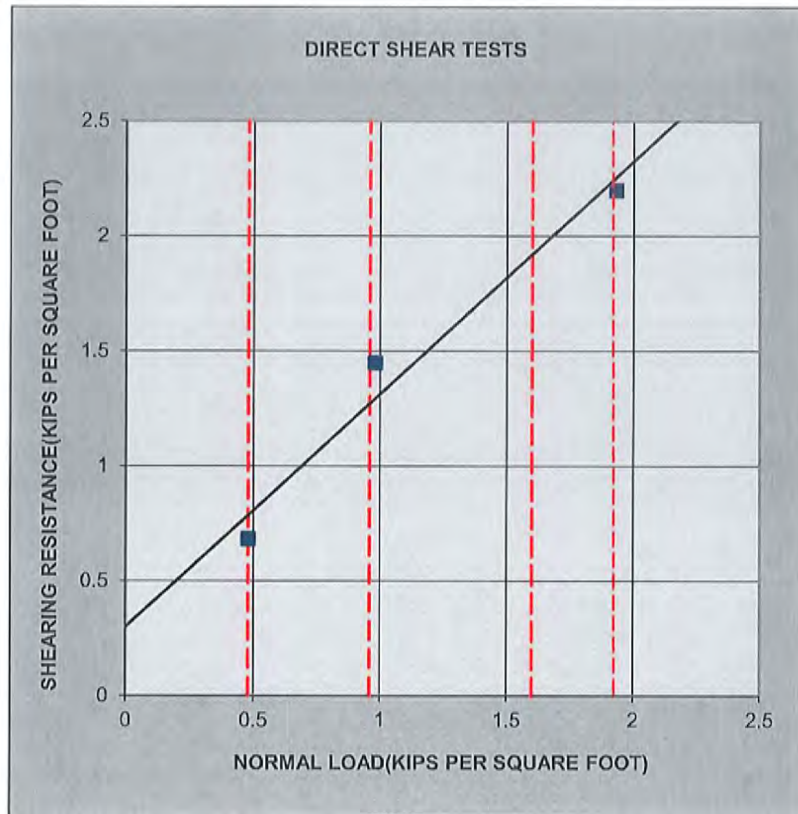

SYMBOL	LOCATION	DEPTH (FT)	TEST CONDITION	COHESION (psf)	FRICTION (degree)
■	B-2	8.0	Undisturbed	300.22	45.36
Proposed EV Truck Leasing Facility 1380 South E Street San Bernardino, California				PROJECT NO.	22051-F
				PLATE	B-1-2



SOILS SOUTHWEST, INC.
Consulting Foundation Engineers

SAND EQUIVALENT TEST

Test Date: October 19, 2022

Project No.: 22051-F

Job Name: WATT EV, Inc. Truck Leasing Facility
1380 S. E Street, San Bernardino

Sample Location: B-5 @ 1-3'

Sample by: MC Tested by: RM

LABORATORY DATA

SAMPLE NO.	1	2	3	4
TIME START	2:40	2:45	2:50	
TIME SOAK (10 min.)	2:50	2:55	3:00	
TIME AT LEVEL 15ML	2:52	2:57	3:02	
TIME of READING (20-min)	3:12	3:17	3:22	
FINE, ML	5.5	5.4	5.8	
COARSE, ML	1.7	1.7	1.5	
SE = 100x (coarse/fine)	30.9	31.48	25.86	
SE Average	29.41			

Soil Description: GP-SP Gravely, fine to coarse, pebbles, rock fragments, rocks

SAND EQUIVALENT TEST

Test Date: October 19, 2022

Project No.: 22051-F

Job Name: WATT EV, Inc. Truck Leasing Facility
1380 S. E Street, San Bernardino

Sample Location: B-6@ 1-3'

Sample by: MC Tested by: RM

LABORATORY DATA

SAMPLE NO.	1	2	3	4
TIME START	3:35	3:40	3:45	
TIME SOAK (10 min.)	3:45	3:50	3:55	
TIME AT LEVEL 15ML	3:47	3:52	3:57	
TIME of READING (20-min)	4:07	4:12	4:17	
FINE, ML	6.8	6.7	7.1	
COARSE, ML	0.5	0.6	0.5	
SE = 100x (coarse/fine)	7.35	8.95	7.04	
SE Average	7.78			

Soil Description: SM Silty fine to medium, pebbles, scattered rock fragments and rocks

GRAIN SIZE DISTRIBUTION

Project: WATT EV, Inc Truck Leasing **Job #** 22051-F
Location: 1380 S. E Street, San Bernardino **Boring No** B-5@1-3' **Sample No:** 3
Description of Soil: GP-SP
Date of Sample: 10/15/2022
Tested By: RM **Date of Testing:** 10/19/2022

Sieve No.	Sieve Openings in mm	Percent Finer	Grain Size	% Retained
4	4.76	89.40	Gravel	11
10	2.38	80.80	Med. to Crs	43
20	0.84	64.60	Fines	38
40	0.42	46.00	Silts	8
60	0.28	32.60	Clays	0
100	0.149	20.60		
200	0.074	8.40		

Gravel	Sand		Silt	Clay
	Coarse to Medium	Fine		

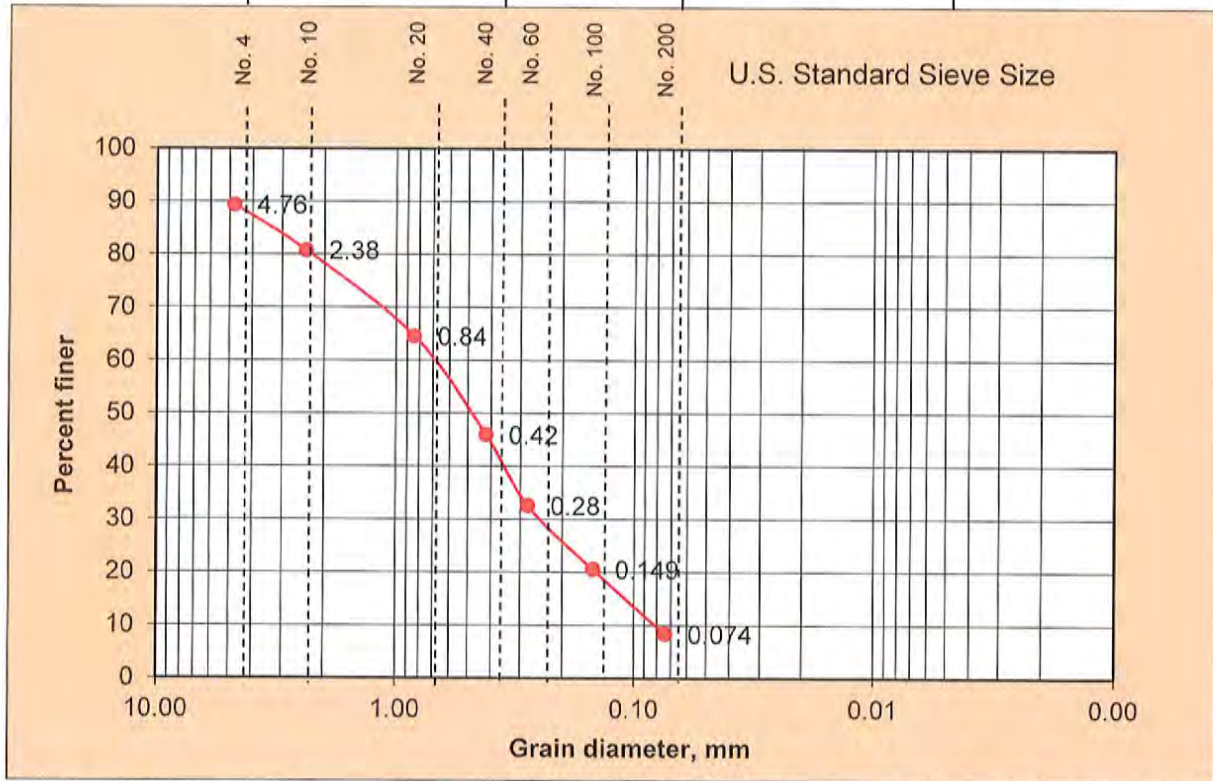

Visual Soil Description : Gravels with sand Sand - light gray brown, traces of silt, gravely fine to coarse sands with rock fragments, rocks
Soil Classification: GP-SP
System: USC

SOILS SOUTHWEST INC.
Consulting Foundation Engineers

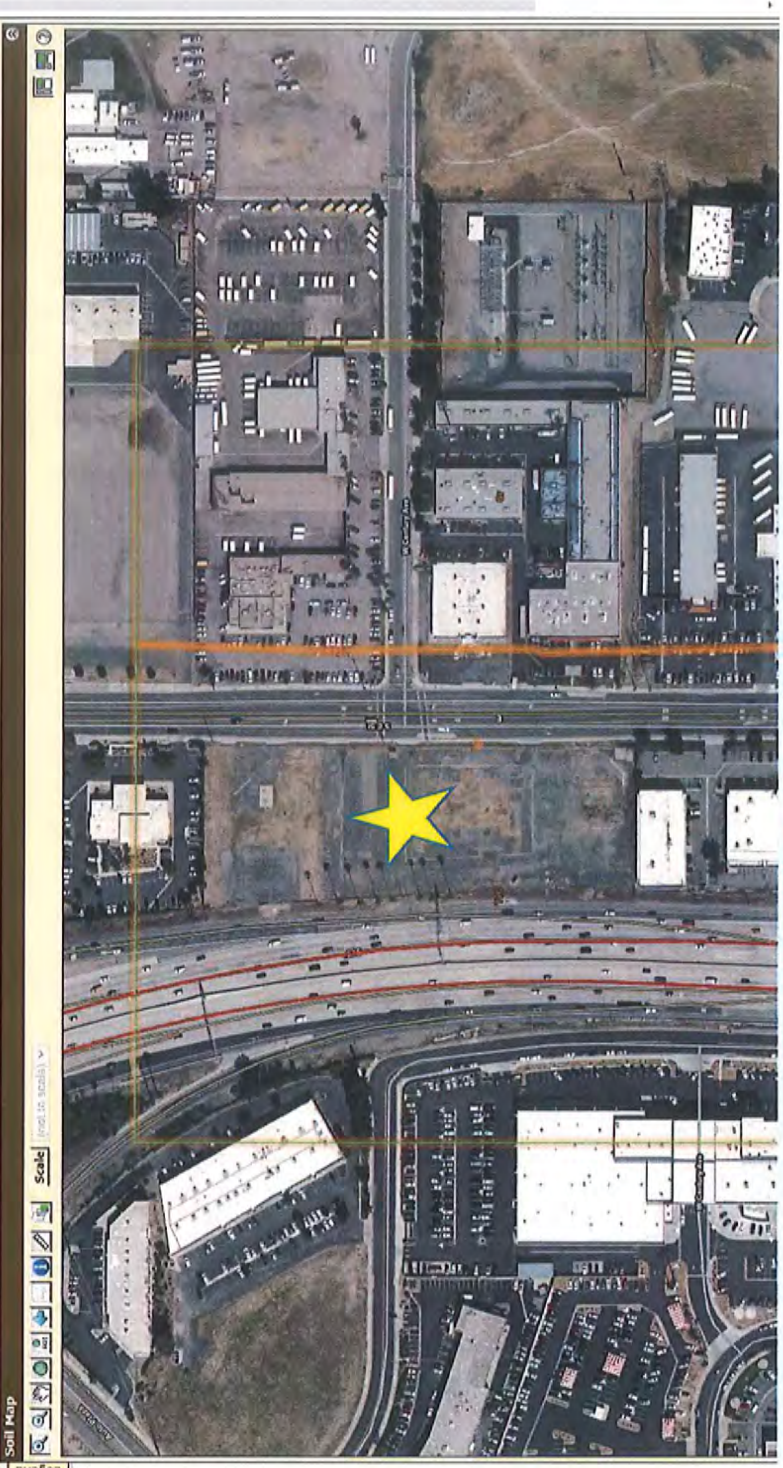

Search
Map Unit Legend

Map Unit Symbol	Map Unit Name	Acres in AOI	Percent of AOI
Gr	Grangeville fine sandy loam, warm MAAT, MLRA 19	13.9	38.2%
Tvc	Tujunga gravelly loamy sand, 0 to 9 percent slopes	22.4	61.8%
Totals for Area of Interest		36.3	100.0%

APPENDIX C

Supplemental Seismic Design Parameters per 2019 CBC,

Liquefaction Analyses,

and

FEMA National Flood Hazard Layer Map

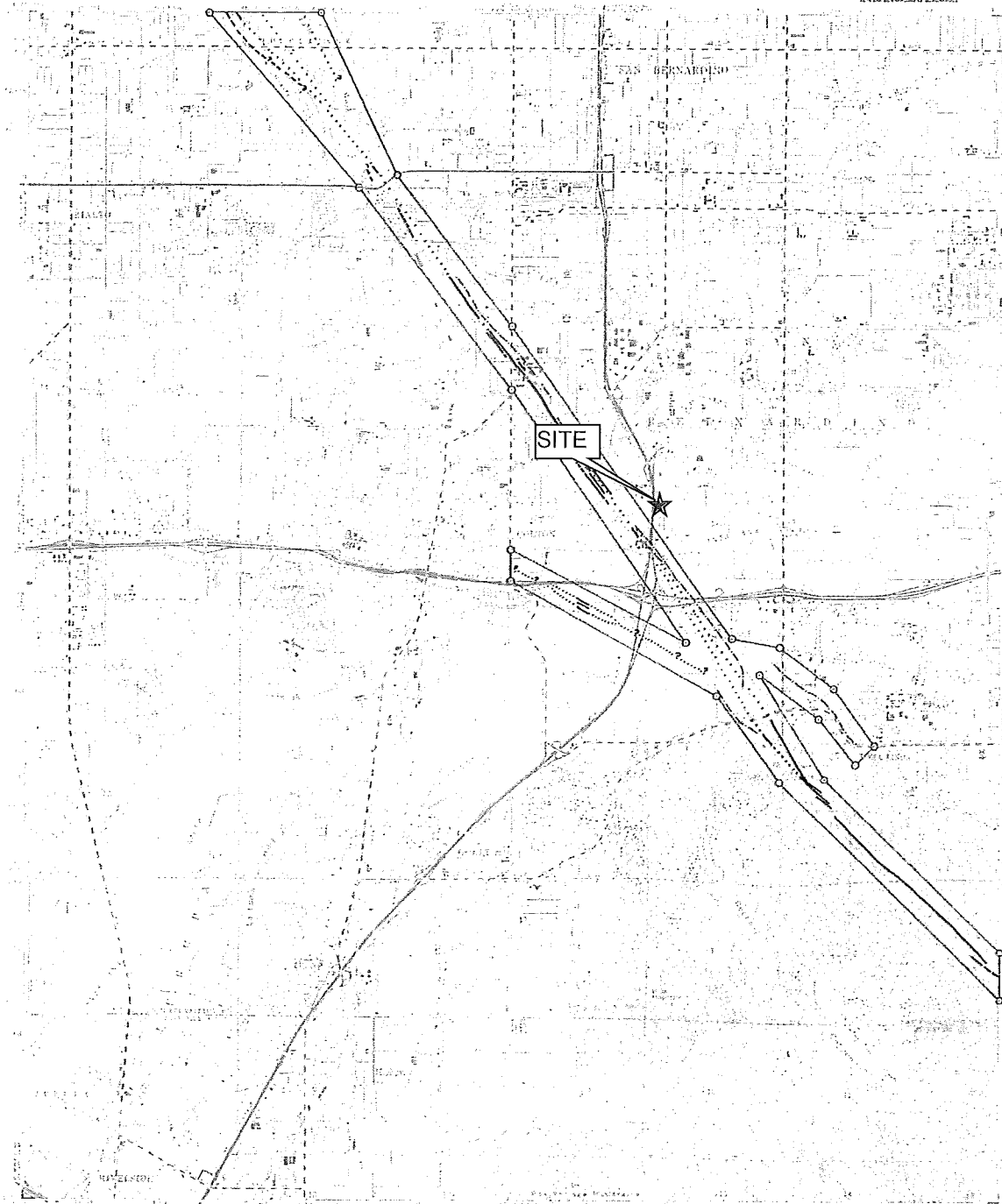

SPANNING AREA OF U.S. GEOLOGICAL SURVEY MAP



REFERENCES USED TO COMPILE FAULT DATA

San Bernardino South Quadrangle
 Cohen, L.C. and Gay, T.E., 1977. Geologic and tectonic maps of the San Bernardino area, California, with notes on the use of the San Bernardino U.S. Geological Survey map. U.S. Geological Survey, Department of the Interior, Geological Survey, San Bernardino, California. 1:50,000 scale. 1977. 12 p.
 Gay, T.E., 1977. Map showing the San Bernardino Fault Zone, San Bernardino County, California. U.S. Geological Survey, Miscellaneous Geologic Map 1879. 1:50,000 scale. 1977. 12 p.
 Gay, T.E., 1977. Geologic map of the San Bernardino area, California, with notes on the use of the San Bernardino U.S. Geological Survey map. U.S. Geological Survey, Department of the Interior, Geological Survey, San Bernardino, California. 1:50,000 scale. 1977. 12 p.

IMPORTANT - PLEASE NOTE

- 1) This map may not show all potentially active faults, either within the special studies zones or outside their boundaries.
- 2) Faults shown are the basis for establishing the boundaries of the special studies zones.
- 3) The identification of these potentially active faults and the location of such fault traces are based on the best available data. Traces have been drawn as accurately as possible at this map scale, however, the quality of data used is highly varied. The faults shown have not been field checked during this map compilation.
- 4) Fault information on this map is not sufficient to serve as a substitute for information developed by the special studies that may be required under Chapter 7.5, Division 2, Section 2623 of the California Public Resources Code.

- MAP EXPLANATION**
- Potentially Active Faults**
- Faults considered to have been active during Quaternary time; solid line where accurately located, long dash where approximately located, short dash where inferred, dotted where concealed; query (?) indicates additional uncertainty. Evidence of historic offset indicated by year of earthquake associated event or C for displacement caused by creep or possible creep.
 - Aerial photo lineaments (not field checked); based on youthful geomorphic and other features believed to be the results of Quaternary faulting.
- Special Studies Zones Boundaries**
- These are delineated as straight-line segments that connect enclosed turning points so as to define special studies zone segments.
 - Seaward projection of zone boundary.

STATE OF CALIFORNIA
SPECIAL STUDIES ZONES
 Delineated in compliance with
 Chapter 7.5, Division 2 of the California Public Resources Code
SAN BERNARDINO SOUTH QUADRANGLE
REVISED OFFICIAL MAP
 Effective: January 1, 1977
T. E. Gay Jr. Acting State Geologist

2008 National Seismic Hazard Maps – Source Parameters

[New Search](#)

Distance in Miles	Name	State	Prof Slip Rate (mm/yr)	Dip (degrees)	Dip Dir	Slip Sense	Rupture Top (km)	Rupture Bottom (km)	Length (km)
0.16	San Jacinto;SBV+SJV+A+CC+B+SM	CA	n/a	90	V	strike slip	0.1	15	241
0.16	San Jacinto;SBV	CA	6	90	V	strike slip	0	16	45
0.16	San Jacinto;SBV+SJV	CA	n/a	90	V	strike slip	0	16	88
0.16	San Jacinto;SBV+SJV+A	CA	n/a	90	V	strike slip	0	16	134
0.16	San Jacinto;SBV+SJV+A+C	CA	n/a	90	V	strike slip	0	17	181
0.16	San Jacinto;SBV+SJV+A+CC	CA	n/a	90	V	strike slip	0	16	181
0.16	San Jacinto;SBV+SJV+A+CC+B	CA	n/a	90	V	strike slip	0.1	15	215
5.16	San Jacinto;SJV+A+C	CA	n/a	90	V	strike slip	0	17	136
5.16	San Jacinto;SJV+A+CC	CA	n/a	90	V	strike slip	0	16	136
5.16	San Jacinto;SJV	CA	18	90	V	strike slip	0	16	43
5.16	San Jacinto;SJV+A+CC+B+SM	CA	n/a	90	V	strike slip	0.1	15	196
5.16	San Jacinto;SJV+A+CC+B	CA	n/a	90	V	strike slip	0.1	15	170
5.16	San Jacinto;SJV+A	CA	n/a	90	V	strike slip	0	17	89
6.50	S. San Andreas;BB+NM+SM+NSB+SSB+BG+CO	CA	n/a	85		strike slip	0.1	13	390
6.50	S. San Andreas;CH+CC+BB+NM+SM+NSB+SSB+BG+CO	CA	n/a	86		strike slip	0.1	13	512
6.50	S. San Andreas;NSB+SSB+BG+CO	CA	n/a	79		strike slip	0.2	12	206
6.50	S. San Andreas;SM+NSB+SSB	CA	n/a	90	V	strike slip	0	13	176

2008 National Seismic Hazard Maps – Source Parameters

[New Search](#)

Fault Name		State		
San Jacinto;SBV+SJV+A+CC+B+SM		California		
GEOMETRY				
Dip (degrees)		90		
Dip direction		V		
Sense of slip		strike slip		
Rupture top (km)		0.1		
Rupture bottom (km)		15		
Rake (degrees)		180		
Length (km)		241		
MODEL VALUES				
Slip Rate		n/a		
Probability of activity		1		
		ELLSWORTH	HANKS	
Minimum magnitude		6.5	6.5	
Maximum magnitude		7.80	7.88	
b-value		0.8	0.8	
Fault Model	Deformation	Char Rate¹	GR-a-	Weight

	Model		value ¹	
Moment Balanced	2.1	9.61e-05 / 9.61e-05	NA / NA	0.25
Moment Balanced	2.2	9.61e-05 / 9.61e-05	NA / NA	0.10
Moment Balanced	2.3	9.61e-05 / 9.61e-05	NA / NA	0.15

¹ 1st Value is based on Ellsworth relation and 2nd value is based on Hanks and Bakun relation



Seismic

Site Soil Class: D - Stiff Soil

Results:

S_s :	2.445	S_{D1} :	N/A
S_1 :	0.98	T_L :	8
F_a :	1	PGA :	1.029
F_v :	N/A	PGA _M :	1.132
S_{MS} :	2.445	F_{PGA} :	1.1
S_{M1} :	N/A	I_e :	1.25
S_{DS} :	1.63	C_v :	1.5

Ground motion hazard analysis may be required. See ASCE/SEI 7-16 Section 11.4.8.

Data Accessed: Mon Oct 17 2022

Date Source: [USGS Seismic Design Maps](#)

Ground Motion Interpolator

Ground Motion Interpolator (2008)

Longitude:

Latitude:

Site Condition (VS30): (180-1050 m/sec)

Return Period:

2% in 50 years 10% in 50 years

Spectral Acceleration:

PGA 0.2 second SA 1.0 second SA

Inputs:

-117.294687, 34.07511
vs30: 270 m/sec
10% in 50 years
PGA

Result:

0.653 g

Information and Disclaimer

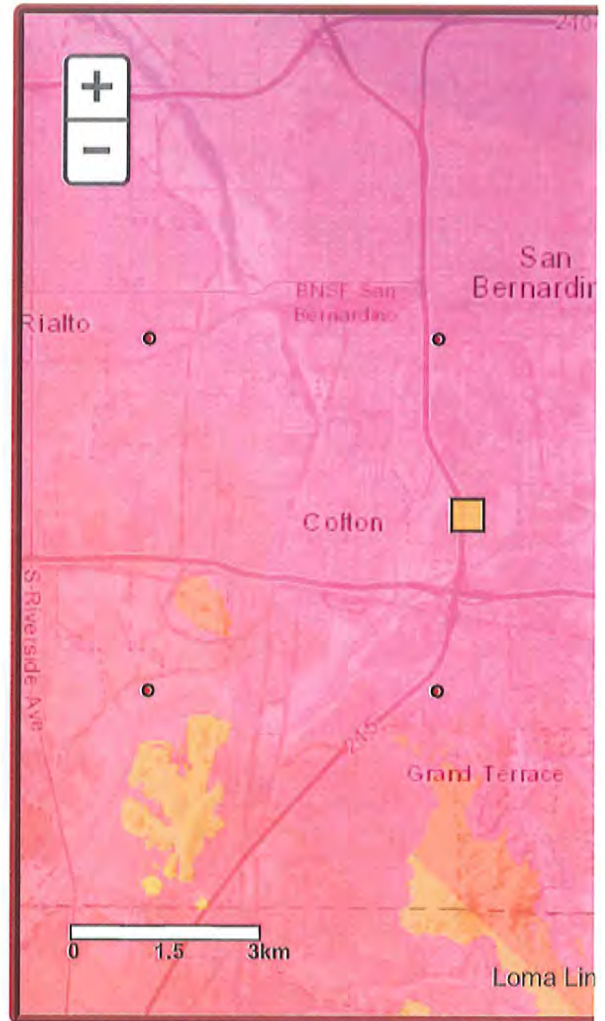

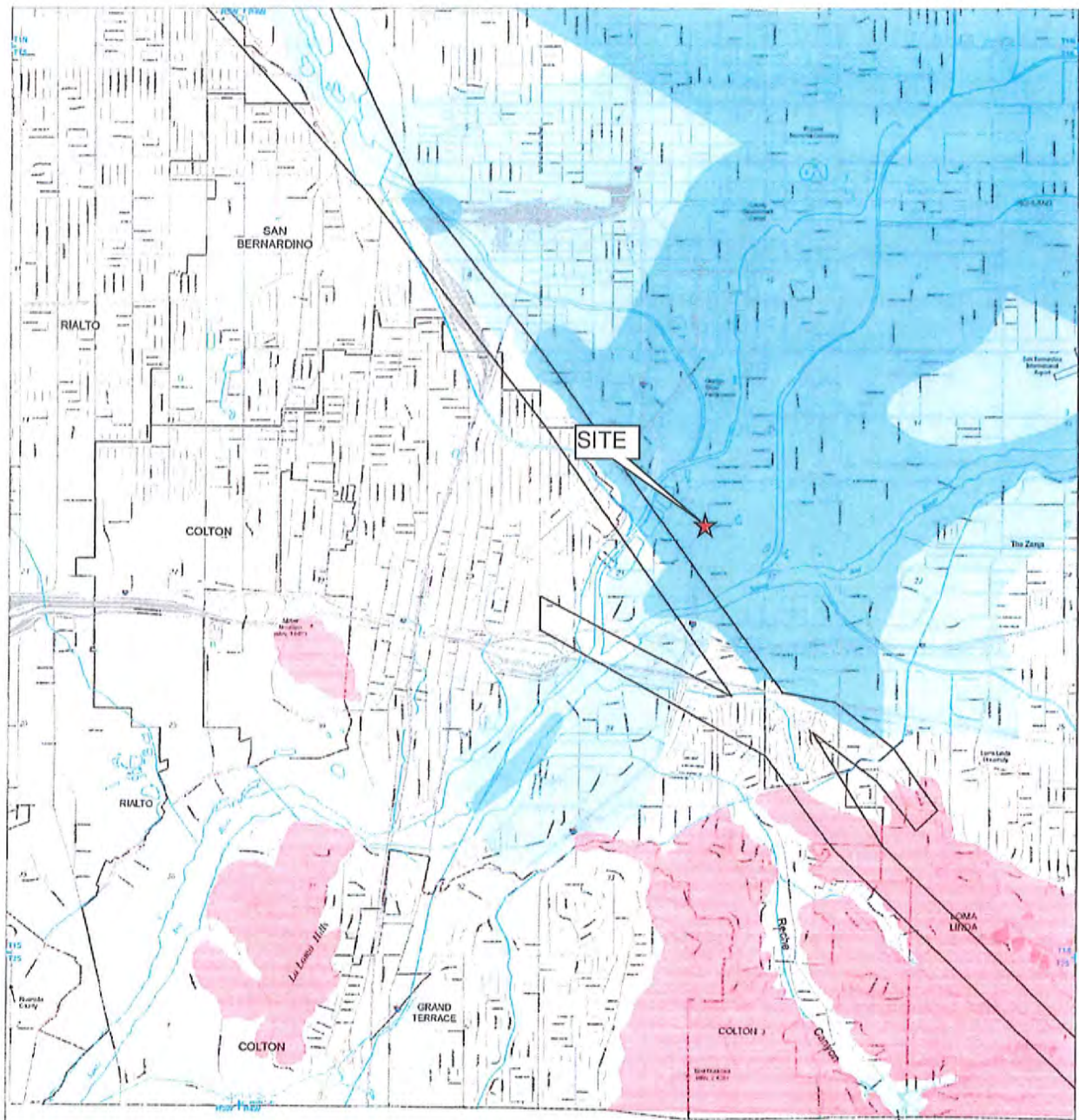

RIVERSIDE COUNTY



Generalized Landslide Susceptibility

- Very Low
- Low
- Medium
- High
- Very High

Zone of Seismicity Susceptibility

- Zone of low susceptibility
- Zone of high susceptibility

San Bernardino County Land Use Plan
GENERAL PLAN
Geologic Hazard Overlays



Generalized Liquefaction Susceptibility

- Low
- Medium
- High

Earthquake Fault Zones

- San Bernardino Fault Zone
- San Gabriel Fault Zone
- San Jacinto Fault Zone
- San Juan Fault Zone
- San Ramon Fault Zone
- San Timoteo Fault Zone
- San Vicente Fault Zone
- San Ysidro Fault Zone
- San Gabriel Fault Zone
- San Jacinto Fault Zone
- San Juan Fault Zone
- San Ramon Fault Zone
- San Timoteo Fault Zone
- San Vicente Fault Zone
- San Ysidro Fault Zone

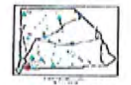

LIQUEFACTION ANALYSIS

Watt Ev, Inc Truck Leasing Facility-Pre Construction

Hole No.=B-1 Water Depth=9.13 ft Surface Elev.=978

Magnitude=7.8
Acceleration=0.653g

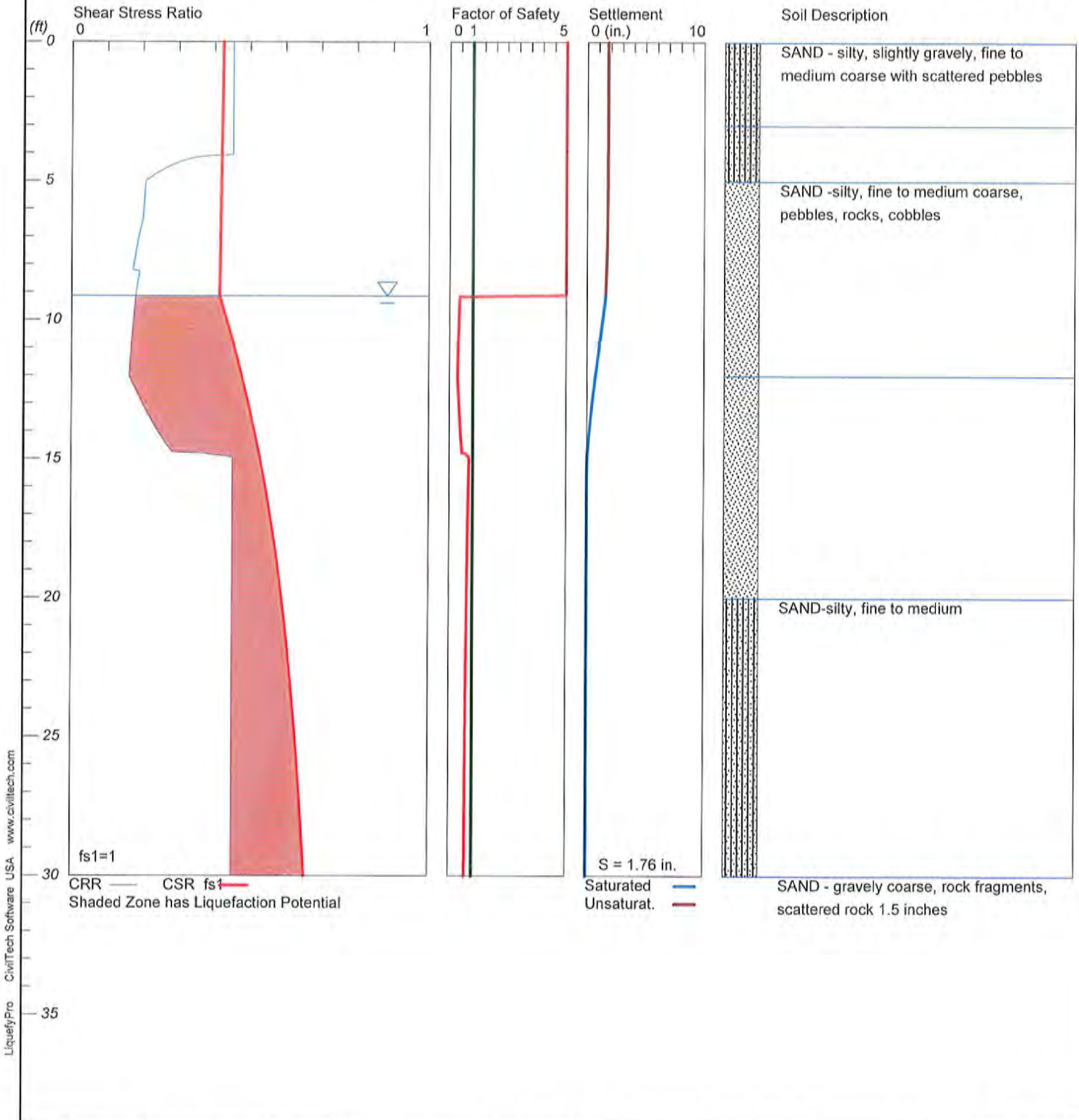

LiquefyPro CivilTech Software USA www.civiltech.com

LIQUEFACTION ANALYSIS SUMMARY

Copyright by CivilTech Software

www.civiltech.com

Font: Courier New, Regular, Size 8 is recommended for this report.

Licensed to , 10/20/2022 3:27:57 PM

Input File Name: UNTITLED

Title: Watt Ev, Inc Truck Leasing Facility-**Pre Construction**

Subtitle: 22051-F

Surface Elev.=978

Hole No.=B-1

Depth of Hole= 30.00 ft

Water Table during Earthquake= 9.13 ft

Water Table during In-Situ Testing= 9.13 ft

Max. Acceleration= 0.65 g

Earthquake Magnitude= 7.80

Input Data:

Surface Elev.=978

Hole No.=B-1

Depth of Hole=30.00 ft

Water Table during Earthquake= 9.13 ft

Water Table during In-Situ Testing= 9.13 ft

Max. Acceleration=0.65 g

Earthquake Magnitude=7.80

No-Liquefiable Soils: CL, OL are Non-Liq. Soil

1. SPT or BPT Calculation.
2. Settlement Analysis Method: Ishihara / Yoshimine
3. Fines Correction for Liquefaction: Stark/Olson et al.*
4. Fine Correction for Settlement: During Liquefaction*
5. Settlement Calculation in: All zones*
6. Hammer Energy Ratio, Ce = 1.0
7. Borehole Diameter, Cb= 1
8. Sampling Method, Cs= 1
9. User request factor of safety (apply to CSR) , User= 1.3
Plot one CSR curve (fs1=1)
10. Use Curve Smoothing: Yes*

* Recommended Options

In-Situ Test Data:

Depth	SPT	gamma	Fines
ft		pcf	%
0.00	31.00	117.00	8.00
3.00	31.00	117.00	8.00
5.00	16.00	113.00	8.00
12.00	10.00	96.00	26.00
20.00	42.00	112.00	6.00
30.00	44.00	112.00	5.00

Output Results:

Settlement of Saturated Sands=1.57 in.

Settlement of Unsaturated Sands=0.19 in.

Total Settlement of Saturated and Unsaturated Sands=1.76 in.

Differential Settlement=0.881 to 1.164 in.

LIQUEFACTION ANALYSIS

Watt Ev, Inc Truck Leasing Facility-Post Construction

Hole No.=B-1 Water Depth=9.13 ft Surface Elev.=978

Magnitude=7.8
Acceleration=0.653g

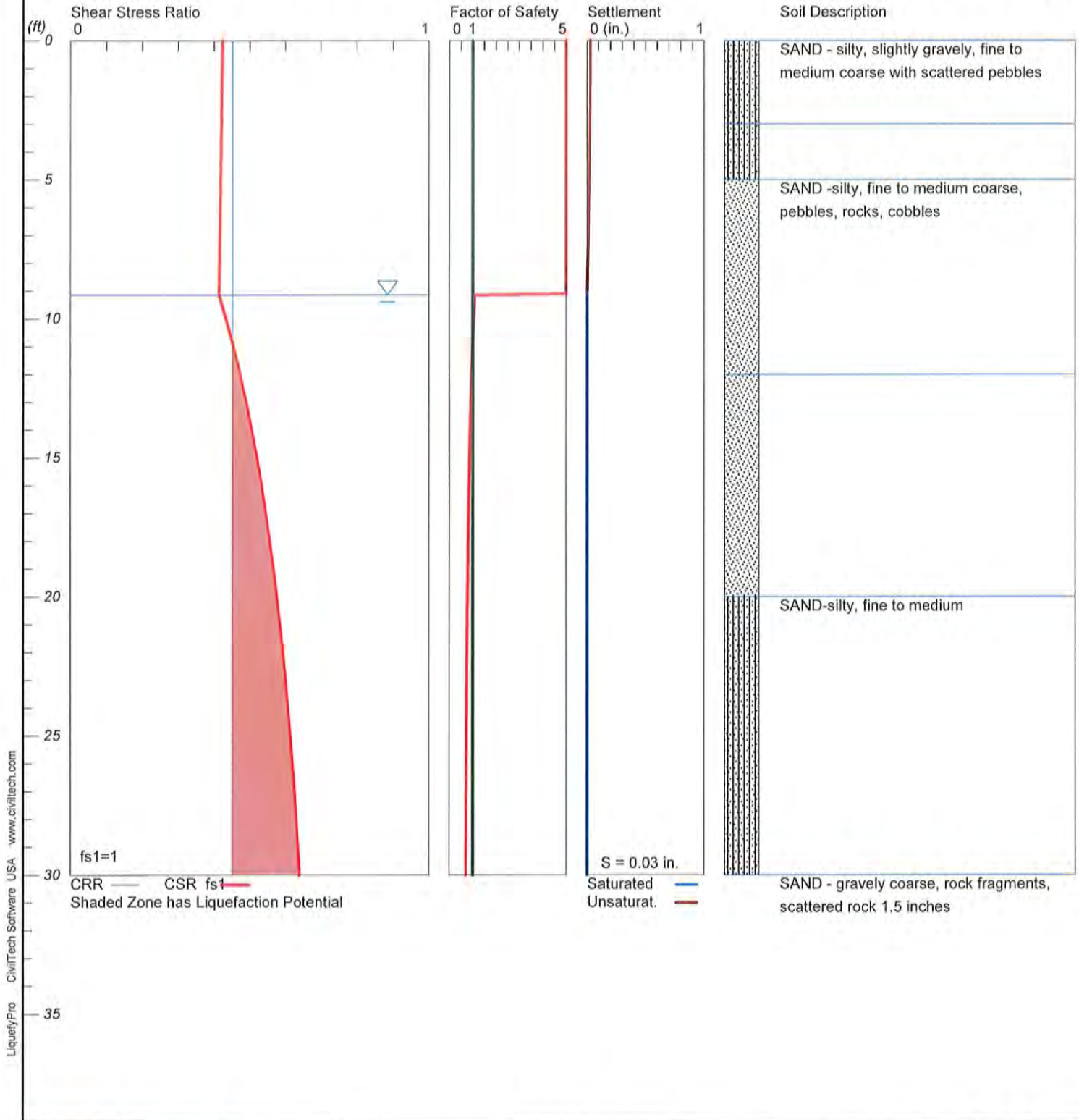

LiquefyPro CivilTech Software USA www.civiltech.com

LIQUEFACTION ANALYSIS SUMMARY

Copyright by CivilTech Software

www.civiltech.com

Font: Courier New, Regular, Size 8 is recommended for this report.

Licensed to , 10/20/2022 3:32:59 PM

Input File Name: D:\Liquefy5\22051-F WattEVSBD.liq

Title: Watt Ev, Inc Truck Leasing Facility-**Post Construction**

Subtitle: 22051-F

Surface Elev.=978

Hole No.=B-1

Depth of Hole= 30.00 ft

Water Table during Earthquake= 9.13 ft

Water Table during In-Situ Testing= 9.13 ft

Max. Acceleration= 0.65 g

Earthquake Magnitude= 7.80

Input Data:

Surface Elev.=978

Hole No.=B-1

Depth of Hole=30.00 ft

Water Table during Earthquake= 9.13 ft

Water Table during In-Situ Testing= 9.13 ft

Max. Acceleration=0.65 g

Earthquake Magnitude=7.80

No-Liquefiable Soils: CL, OL are Non-Liq. Soil

1. SPT or BPT Calculation.
2. Settlement Analysis Method: Ishihara / Yoshimine
3. Fines Correction for Liquefaction: Stark/Olson et al.*
4. Fine Correction for Settlement: Post Liquefaction
5. Settlement Calculation in: All zones*
6. Hammer Energy Ratio, Ce = 1.0
7. Borehole Diameter, Cb= 1
8. Sampling Method, Cs= 1
9. User request factor of safety (apply to CSR) , User= 1.3
Plot one CSR curve (fs1=1)
10. Use Curve Smoothing: Yes*

* Recommended Options

In-Situ Test Data:

Depth ft	SPT	gamma pcf	Fines %
0.00	31.00	117.00	8.00
3.00	31.00	117.00	8.00
5.00	30.00	113.00	8.00
12.00	30.00	112.00	26.00
20.00	42.00	112.00	6.00
30.00	44.00	112.00	5.00

Output Results:

Settlement of Saturated Sands=0.00 in.

Settlement of Unsaturated Sands=0.03 in.

Total Settlement of Saturated and Unsaturated Sands=0.03 in.

Differential Settlement=0.014 to 0.019 in.

National Flood Hazard Layer FIRMette



117°17'58"W 34°44'7"N



LOMR, 18-09
 eff. 11/22/20

Legend

SEE FIS REPORT FOR DETAILED LEGEND AND INDEX MAP FOR FIRM PANEL LAYOUT

SPECIAL FLOOD HAZARD AREAS

- Without Base Flood Elevation (BFE)
 Zone A, V, AE, AH, VE, AR
- With BFE or Depth Zone AE, AO, AH, VE, AR
- Regulatory Floodway

OTHER AREAS OF FLOOD HAZARD

- 0.2% Annual Chance Flood Hazard, Areas of 1% annual chance flood with average depth less than one foot or with drainage areas of less than one square mile Zone X
- Future Conditions 1% Annual Chance Flood Hazard Zone X
- Area with Reduced Flood Risk due to Levee. See Notes. Zone X
- Area with Flood Risk due to Levee Zone D

OTHER AREAS GENERAL STRUCTURES

- NO SCREEN
- Area of Minimal Flood Hazard Zone X
- Effective LOMRs
- Area of Undetermined Flood Hazard Zone D
- Channel, Culvert, or Storm Sewer Levee, Dike, or Floodwall

OTHER FEATURES

- 20.2 Cross Sections with 1% Annual Chance Water Surface Elevation
- Coastal Transect
- Base Flood Elevation Line (BFE)
- Limit of Study
- Coastal Transect Baseline
- Profile Baseline
- Hydrographic Feature

MAP PANELS

- Digital Data Available
- No Digital Data Available
- Unmapped



The pin displayed on the map is an approximate point selected by the user and does not represent an authoritative property location.

This map complies with FEMA's standards for the use of digital flood maps. If it is not void as described below. The basemap shown complies with FEMA's basemap accuracy standards.

The flood hazard information is derived directly from the authoritative NFHL web services provided by FEMA. This map was exported on 10/17/2022 at 1:45 PM and does not reflect changes or amendments subsequent to this date and time. The NFHL and effective information may change or become superseded by new data over time.

This map image is void if the one or more of the following map elements do not appear: basemap imagery, flood zone labels, legend, scale bar, map creation date, community identifiers, FIRM panel number, and FIRM effective date. Map images for unmapped and unmodernized areas cannot be used for regulatory purposes.

Feet 1:6,000

117°17'20"W 34°4'17"N

Basemap: USGS National Map: Orthoimagery: Data refreshed October, 2020

APPENDIX D

Soil Infiltration Test Data Porchet Method Calculation Summary

Conversion Table (Porchet Method)

WattEV

1380 S. E Street, San Bernardino

Project No. 22051-FBMP

Test No.	Test Hole Depth (inches) D_T	Time Interval ΔT	Initial Depth (inches) D_o (in)	Final Depth (inches) D_f (in)	Initial Water Height (inches) $H_o = D_T - D_o$	Final Water Height (inches) $H_f = D_T - D_f$	Change Height/Time $\Delta H / \Delta D = H_o - H_f$	Average Head Height/Time $H_{avg} = (H_o + H_f) / 2$
P-1	144	10	120	132.25	24	11.75	12.25	17.875
P-2	144	10	120	131.5	24	12.5	11.5	18.25

Observed Infiltration Rate (lt) = $\Delta H_{60r} / \Delta t (r+2H_{avg})$		
A	B	C
ΔH_{60r}	$\Delta t (r+2H_{avg})$	A/B = inc/hr
P-1 2940	397.5	7.40
P-2 2760	405	6.81

Legend

- $\Delta H / \Delta D$ = Observed Field Rate
- H_o = inches of water filled from bottom
- D_o = initial height of water (inches) from bottom
- D_f = final height of water (inches) from bottom
- Columns A-B-C : Porchet Conversion Calculations
- Column C: Observed Rate following Porchet Conversion
- D_t = depth of test hole bottom (inches)

Percolation Test Data Sheet

Project: <u>WA77 EV/Truck Lease Facility</u>			Project No. <u>22051-BMP</u>		
Test Hole No:	<u>P-1</u>	Tested By: <u>RM/JF</u>	Date: <u>10/19/22</u>		
Depth of Test Hole, D_T	<u>144</u>	USCS Soil Classification <u>SP</u>			
Test Hole Dimensions (inches)			Length	Width	
Diameter (if round)=	<u>8.0 in.</u>	Sides (if rectangular)=			

Sandy Soil Criteria Test *

Trial No.	Start Time	Stop Time	Δt Time Interval (min)	D_o Initial Depth to Water (in.)	D_f Final Depth to Water (in.)	ΔD Change in Water Level (in.)	Greater Than or Equal to 6.0 inches?? (Y/N)
<u>1</u>	<u>9:22</u>	<u>9:47</u>	<u>25</u>	<u>120</u>	<u>144</u>	<u>24</u>	<u>Y</u>
<u>2</u>	<u>9:49</u>	<u>10:14</u>	<u>25</u>	<u>120</u>	<u>144</u>	<u>24</u>	<u>Y</u>

* If two consecutive measurements show that six inches of water seeps away in less than 25 minutes, the test shall be run for an additional hour with measurements taken every 10 minutes. Otherwise, pre-soak (fill) overnight. Obtain at least twelve measurements per hole over at least six hours (approximately 30 minute intervals) with a precision of at least 0.25."

Trial No.	Start Time	Stop Time	Δt Time Interval (min)	D_o Initial Depth to Water (in.)	D_f Final Depth to Water (in.)	ΔD Change in Water Level (in.)	$\Delta T/\Delta D$ Percolation Rate (min./in.)
<u>1</u>	<u>10:15</u>	<u>10:25</u>	<u>10</u>	<u>120</u>	<u>136.25</u>	<u>16.25</u>	<u>0.62</u>
<u>2</u>	<u>10:26</u>	<u>10:36</u>	<u>10</u>	<u>120</u>	<u>136.00</u>	<u>16.00</u>	<u>0.63</u>
<u>3</u>	<u>10:37</u>	<u>10:47</u>	<u>10</u>	<u>120</u>	<u>135.25</u>	<u>15.25</u>	<u>0.66</u>
<u>4</u>	<u>10:48</u>	<u>10:58</u>	<u>10</u>	<u>120</u>	<u>134.75</u>	<u>14.75</u>	<u>0.68</u>
<u>5</u>	<u>10:59</u>	<u>11:09</u>	<u>10</u>	<u>120</u>	<u>134.00</u>	<u>14.00</u>	<u>0.71</u>
<u>6</u>	<u>11:10</u>	<u>11:20</u>	<u>10</u>	<u>120</u>	<u>133.50</u>	<u>13.50</u>	<u>0.74</u>
<u>7</u>	<u>11:21</u>	<u>11:31</u>	<u>10</u>	<u>120</u>	<u>133.00</u>	<u>13.00</u>	<u>0.77</u>
<u>8</u>	<u>11:32</u>	<u>11:42</u>	<u>10</u>	<u>120</u>	<u>132.75</u>	<u>12.75</u>	<u>0.78</u>
<u>9</u>	<u>11:43</u>	<u>11:53</u>	<u>10</u>	<u>120</u>	<u>132.75</u>	<u>12.75</u>	<u>0.78</u>
<u>10</u>	<u>11:54</u>	<u>12:04</u>	<u>10</u>	<u>120</u>	<u>132.25</u>	<u>12.25</u>	<u>0.82</u>
<u>11</u>	<u>12:05</u>	<u>12:15</u>	<u>10</u>	<u>120</u>	<u>132.25</u>	<u>12.25</u>	<u>0.82</u>
<u>12</u>	<u>12:16</u>	<u>12:26</u>	<u>10</u>	<u>120</u>	<u>132.25</u>	<u>12.25</u>	<u>0.82</u>
<u>13</u>	<u>12:27</u>	<u>12:37</u>	<u>10</u>	<u>120</u>	<u>132.25</u>	<u>12.25</u>	<u>0.82</u>
<u>14</u>							
<u>15</u>							
<u>16</u>							
<u>17</u>							
<u>18</u>							

Comments

Percolation Test Data Sheet

Project: *EV WATT / San Bernard: 92* Project No. *22051-BMP*

Test Hole No: *P2* Tested By: *R. Muñoz* Date: *10-19-22*

Depth of Test Hole, D_T *144* USCS Soil Classification

Test Hole Dimensions (inches) Length Width

Diameter (if round)= *8.0 in.* Sides (if rectangular)=

North

Sandy Soil Criteria Test *

Trial No.	Start Time	Stop Time	Δt Time Interval (min)	D_o Initial Depth to Water (in.)	D_f Final Depth to Water (in.)	ΔD Change in Water Level (in.)	Greater Than or Equal to 6.0 inches??? (Y/N)
<i>1</i>	<i>9:32</i>	<i>9:57</i>	<i>25</i>	<i>120"</i>	<i>143"</i>	<i>23"</i>	<i>Y</i>
<i>2</i>	<i>9:59</i>	<i>10:24</i>	<i>25</i>	<i>120"</i>	<i>140 1/2"</i>	<i>20 1/2"</i>	<i>Y</i>

* If two consecutive measurements show that six inches of water seeps away in less than 25 minutes, the test shall be run for an additional hour with measurements taken every 10 minutes. Otherwise, pre-soak (fill) overnight. Obtain at least twelve measurements per hole over at least six hours (approximately 30 minute intervals) with a precision of at least 0.25."

Trial No.	Start Time	Stop Time	Δt Time Interval (min)	D_o Initial Depth to Water (in.)	D_f Final Depth to Water (in.)	ΔD Change in Water Level (in.)	$\Delta T / \Delta D$ Percolation Rate (min./in.)
<i>1</i>	<i>10:22</i>	<i>10:32</i>	<i>10</i>	<i>120"</i>	<i>131 1/2</i>	<i>11 1/2</i>	<i>0.87</i>
<i>2</i>	<i>10:33</i>	<i>10:43</i>	<i>10</i>	<i>120"</i>	<i>131 1/2</i>	<i>11 1/2</i>	<i>0.87</i>
<i>3</i>	<i>10:44</i>	<i>10:54</i>	<i>10</i>	<i>120"</i>	<i>131 1/2</i>	<i>11 1/2</i>	<i>0.87</i>
<i>4</i>	<i>10:55</i>	<i>11:05</i>	<i>10</i>	<i>120"</i>	<i>131 1/2</i>	<i>11 1/2</i>	<i>0.87</i>
<i>5</i>	<i>11:06</i>	<i>11:16</i>	<i>10</i>	<i>120"</i>	<i>131 1/2</i>	<i>11 1/2</i>	<i>0.87</i>
<i>6</i>	<i>11:17</i>	<i>11:27</i>	<i>10</i>	<i>120"</i>	<i>131 1/2</i>	<i>11 1/2</i>	<i>0.87</i>
<i>7</i>							
<i>8</i>							
<i>9</i>							
<i>10</i>							
<i>11</i>							
<i>12</i>							
<i>13</i>							
<i>14</i>							
<i>15</i>							
<i>16</i>							
<i>17</i>							
<i>18</i>							

Comments

Form 4.3-3 Infiltration LID BMP - including underground BMPs (DA 1)			
1 Remaining LID DCV not met by site design BMP (ft ³): $V_{unmet} = \text{Form 4.2-1 Item 7} - \text{Form 4.3-2 Item 19}$			
BMP Type Use columns to the right to compute runoff volume retention from proposed infiltration BMP (select BMP from Table 5-4 in TGD for WQMP) - Use additional forms for more BMPs	DA DMA BMP Type	DA DMA BMP Type	DA DMA BMP Type (Use additional forms for more BMPs)
2 Infiltration rate of underlying soils (in/hr) See Section 5.4.2 and Appendix C of the TGD for WQMP for minimum requirements for assessment methods	7.40	6.81	
3 Infiltration safety factor See TGD Section 5.4.2 and Appendix D			
4 Design percolation rate (in/hr) $P_{design} = \text{Item 2} / \text{Item 3}$			
5 Pondered water drawdown time (hr) Copy Item 6 in Form 4.2-1			
6 Maximum ponding depth (ft) BMP specific, see Table 5-4 of the TGD for WQMP for BMP design details			
7 Ponding Depth (ft) $d_{BMP} = \text{Minimum of } (1/12 * \text{Item 4} * \text{Item 5}) \text{ or Item 6}$			
8 Infiltrating surface area, SA_{BMP} (ft ²) the lesser of the area needed for infiltration of full DCV or minimum space requirements from Table 5.7 of the TGD for WQMP			
9 Amended soil depth, d_{media} (ft) Only included in certain BMP types, see Table 5-4 in the TGD for WQMP for reference to BMP design details			
10 Amended soil porosity			
11 Gravel depth, d_{media} (ft) Only included in certain BMP types, see Table 5-4 of the TGD for WQMP for BMP design details			
12 Gravel porosity			
13 Duration of storm as basin is filling (hrs) Typical ~ 3hrs			
14 Above Ground Retention Volume (ft ³) $V_{retention} = \text{Item 8} * [\text{Item 7} + (\text{Item 9} * \text{Item 10}) + (\text{Item 11} * \text{Item 12}) + (\text{Item 13} * (\text{Item 4} / 12))]$			
15 Underground Retention Volume (ft ³) Volume determined using manufacturer's specifications and calculations			
16 Total Retention Volume from LID Infiltration BMPs: (Sum of Items 14 and 15 for all infiltration BMP included in plan)			
17 Fraction of DCV achieved with infiltration BMP: % Retention% = Item 16 / Form 4.2-1 Item 7			
18 Is full LID DCV retained onsite with combination of hydrologic source control and LID retention/infiltration BMPs? Yes <input type="checkbox"/> No <input type="checkbox"/> If yes, demonstrate conformance using Form 4.3-10; If no, then reduce Item 3, Factor of Safety to 2.0 and increase Item 8, Infiltrating Surface Area, such that the portion of the site area used for retention and infiltration BMPs equals or exceeds the minimum effective area thresholds (Table 5-7 of the TGD for WQMP) for the applicable category of development and repeat all above calculations.			

PROFESSIONAL LIMITATIONS

Our investigation was performed using the degree of care and skill ordinarily exercised, under similar circumstances by other reputable soils engineers practicing in these general or similar localities. No other warranty, expressed or implied, is made as to the conclusions and professional advice included in this report.

The investigations are based on soil samples only, consequently the recommendations provided shall be considered 'preliminary'. The samples taken and used for testing and the observations made are believed representative of site conditions; however, soil and geologic conditions can vary significantly between boring. As in most major projects, conditions revealed by excavations may vary with preliminary findings. If this occurs, the changed conditions must be evaluated by the project soils engineer and designs adjusted as required or alternate design recommended.

The report is issued with the understanding that it is the responsibility of the owner or of his/her representative to ensure that the information and recommendations contained herein are brought to the attention of the project architect and engineers. Appropriate recommendations shall be incorporated into structural plans.

The findings of this report are valid as of this present date. However, changes in the conditions of a property can occur with the passage of time, whether they are due to natural process or the works of man on this or adjacent properties. In addition, changes in applicable or appropriate standards may occur from legislation or broadening of knowledge. Accordingly, the findings of this report may be invalidated wholly or partially by change outside of our control. Therefore, this report is subject to review and shall be updated after a period of one year.

RECOMMENDED SERVICES

The review of grading plans and specifications, field observations and testing by a geotechnical representative of this office is integral part of the conclusions and recommendations made in this report. If Soils Southwest, Inc. (SSW) is not retained for these services, the Client agrees to assume SSW's responsibility for any potential claims that may arise during and after construction or during the lifetime use of the structure and its appurtenant.

The recommendations supplied shall be considered valid and applicable, provided the following conditions, at a minimum, are met:

- i. Pre-grade meeting with the contractor, public agency, and the soils engineer,
- ii. Excavated bottom inspections and verifications by soils engineer prior to backfill placement,
- iii. Continuous observations and testing during site preparation and structural fill soils placement,
- iv. Observation and inspection of footing trenching prior to steel and concrete placement,
- v. Subgrade verifications including plumbing trenches backfills prior to concrete slab-on-grade placement,
- vi. On and off-site utility trenches backfills testing and verifications,
- vii. Precise-grading plan review, and
- viii. Consultations as required during construction or upon request.

In the event that the above conditions are not fulfilled, Soils Southwest, Inc. will assume no responsibility for any structural distresses during the lifetime use of the planned development.

Worksheet H: Factor of Safety and Design Infiltration Rate and Worksheet

Factor Category		Factor Description	Assigned Weight (w)	Factor Value (v)	Product (p) $p = w \times v$
A	Suitability Assessment	Soil assessment methods	0.25	1	0.25
		Predominant soil texture	0.25	1	0.25
		Site soil variability	0.25	1	0.25
		Depth to groundwater / impervious layer	0.25	2	0.50
		Suitability Assessment Safety Factor, $S_A = \sum p$			
B	Design	Tributary area size	0.25	2	0.50
		Level of pretreatment/ expected sediment loads	0.25	2	0.50
		Redundancy	0.25	3	0.75
		Compaction during construction	0.25	2	0.50
		Design Safety Factor, $S_B = \sum p$			
Combined Safety Factor, $S_{Total} = S_A \times S_B$				2.81	
Observed Infiltration Rate, inch/hr, $K_{observed}$ (corrected for test-specific bias)				7.10	
Design Infiltration Rate, in/hr, $K_{DESIGN} = K_{Observed} / S_{Total}$				2.52	
Supporting Data					
Briefly describe infiltration test and provide reference to test forms: See soils report No. 22051-F/BMP by Soils Southwest, Inc. in Appendix 6.4. The observed infiltration rate was calculated averaging the two infiltration rates observed using the two Porchet method tests no. P-1 and P-2: $(7.40 + 6.81)/2 = 7.10$					

Note: The minimum combined adjustment factor shall not be less than 2.0 and the maximum combined adjustment factor shall not exceed 9.0.

Source Control/Site Design BMPs

Spill Prevention, Control & Cleanup SC-11

Description

Many activities that occur at an industrial or commercial site have the potential to cause accidental spills. Preparation for accidental spills, with proper training and reporting systems implemented, can minimize the discharge of pollutants to the environment.

Spills and leaks are one of the largest contributors of stormwater pollutants. Spill prevention and control plans are applicable to any site at which hazardous materials are stored or used. An effective plan should have spill prevention and response procedures that identify hazardous material storage areas, specify material handling procedures, describe spill response procedures, and provide locations of spill clean-up equipment and materials. The plan should take steps to identify and characterize potential spills, eliminate and reduce spill potential, respond to spills when they occur in an effort to prevent pollutants from entering the stormwater drainage system, and train personnel to prevent and control future spills. An adequate supply of spill clean-up materials must be maintained onsite.

Approach

General Pollution Prevention Protocols

- Develop procedures to prevent/mitigate spills to storm drain systems.
- Develop and standardize reporting procedures, containment, storage, and disposal activities, documentation, and follow-up procedures.
- Establish procedures and/or controls to minimize spills and leaks. The procedures should address:
 - ✓ Description of the facility, owner and address, activities, chemicals, and quantities present;

Objectives

- Cover
- Contain
- Educate
- Reduce/Minimize
- Product Substitution

Targeted Constituents

Sediment	
Nutrients	
Trash	
Metals	✓
Bacteria	
Oil and Grease	✓
Organics	✓

Minimum BMPs Covered

 Good Housekeeping	
 Preventative Maintenance	
 Spill and Leak Prevention and Response	✓
 Material Handling & Waste Management	
 Erosion and Sediment Controls	
 Employee Training Program	✓
 Quality Assurance Record Keeping	✓



Spill Prevention, Control & Cleanup SC-11

- ✓ Facility map of the locations of industrial materials;
 - ✓ Notification and evacuation procedures;
 - ✓ Cleanup instructions;
 - ✓ Identification of responsible departments; and
 - ✓ Identify key spill response personnel.
- Recycle, reclaim, or reuse materials whenever possible. This will reduce the amount of process materials that are brought into the facility.



Spill and Leak Prevention and Response

Spill Prevention

- Develop procedures to prevent/mitigate spills to storm drain systems. Develop and standardize reporting procedures, containment, storage, and disposal activities, documentation, and follow-up procedures.
- If illegal dumping is observed at the facility:
 - ✓ Post “No Dumping” signs with a phone number for reporting illegal dumping and disposal. Signs should also indicate fines and penalties applicable for illegal dumping.
 - ✓ Landscaping and beautification efforts may also discourage illegal dumping.
 - ✓ Bright lighting and/or entrance barriers may also be needed to discourage illegal dumping.
- Store and contain liquid materials in such a manner that if the container is ruptured, the contents will not discharge, flow, or be washed into the storm drainage system, surface waters, or groundwater.
- If the liquid is oil, gas, or other material that separates from and floats on water, install a spill control device (such as a tee section) in the catch basins that collect runoff from the storage tank area.



Preventative Maintenance

- Place drip pans or absorbent materials beneath all mounted taps, and at all potential drip and spill locations during filling and unloading of tanks. Any collected liquids or soiled absorbent materials must be reused/recycled or properly disposed.
- Store and maintain appropriate spill cleanup materials in a location known to all near the tank storage area; and ensure that employees are familiar with the site’s spill control plan and/or proper spill cleanup procedures.

Spill Prevention, Control & Cleanup SC-11

- Sweep and clean the storage area monthly if it is paved, *do not hose down the area to a storm drain.*
- Check tanks (and any containment sumps) daily for leaks and spills. Replace tanks that are leaking, corroded, or otherwise deteriorating with tanks in good condition. Collect all spilled liquids and properly dispose of them.
- Label all containers according to their contents (e.g., solvent, gasoline).
- Label hazardous substances regarding the potential hazard (corrosive, radioactive, flammable, explosive, poisonous).
- Prominently display required labels on transported hazardous and toxic materials (per US DOT regulations).
- Identify key spill response personnel.

Spill Response

- Clean up leaks and spills immediately.
- Place a stockpile of spill cleanup materials where it will be readily accessible (e.g., near storage and maintenance areas).
- On paved surfaces, clean up spills with as little water as possible.
 - ✓ Use a rag for small spills, a damp mop for general cleanup, and absorbent material for larger spills.
 - ✓ If the spilled material is hazardous, then the used cleanup materials are also hazardous and must be sent to a certified laundry (rags) or disposed of as hazardous waste.
 - ✓ If possible use physical methods for the cleanup of dry chemicals (e.g., brooms, shovels, sweepers, or vacuums).
- Never hose down or bury dry material spills. Sweep up the material and dispose of properly.
- Chemical cleanups of material can be achieved with the use of adsorbents, gels, and foams. Use adsorbent materials on small spills rather than hosing down the spill. Remove the adsorbent materials promptly and dispose of properly.
- For larger spills, a private spill cleanup company or Hazmat team may be necessary.

Spill Prevention, Control & Cleanup SC-11

Reporting

- Report spills that pose an immediate threat to human health or the environment to the Regional Water Quality Control Board or local authority as location regulations dictate.
- Federal regulations require that any oil spill into a water body or onto an adjoining shoreline be reported to the National Response Center (NRC) at 800-424-8802 (24 hour).
- Report spills to 911 for dispatch and clean-up assistance when needed. Do not contact fire agencies directly.
- Establish a system for tracking incidents. The system should be designed to identify the following:
 - ✓ Types and quantities (in some cases) of wastes;
 - ✓ Patterns in time of occurrence (time of day/night, month, or year);
 - ✓ Mode of dumping (abandoned containers, “midnight dumping” from moving vehicles, direct dumping of materials, accidents/spills);
 - ✓ Clean-up procedures; and
 - ✓ Responsible parties.



Employee Training Program

- Educate employees about spill prevention and cleanup.
- Well-trained employees can reduce human errors that lead to accidental releases or spills:
 - ✓ The employee should have the tools and knowledge to immediately begin cleaning up a spill should one occur; and
 - ✓ Employees should be familiar with the Spill Prevention Control and Countermeasure Plan.
- Employees should be educated about aboveground storage tank requirements. Employees responsible for aboveground storage tanks and liquid transfers should be thoroughly familiar with the Spill Prevention Control and Countermeasure Plan and the plan should be readily available.
- Train employees to recognize and report illegal dumping incidents.

Spill Prevention, Control & Cleanup SC-11

Other Considerations (Limitations and Regulations)

- ❑ State regulations exist for facilities with a storage capacity of 10,000 gallons or more of petroleum to prepare a Spill Prevention Control and Countermeasure (SPCC) Plan (Health & Safety Code Chapter 6.67).
- ❑ State regulations also exist for storage of hazardous materials (Health & Safety Code Chapter 6.95), including the preparation of area and business plans for emergency response to the releases or threatened releases.
- ❑ Consider requiring smaller secondary containment areas (less than 200 sq. ft.) to be connected to the sanitary sewer, prohibiting any hard connections to the storm drain.

Requirements

Costs (including capital and operation & maintenance)

- ❑ Will vary depending on the size of the facility and the necessary controls.
- ❑ Prevention of leaks and spills is inexpensive. Treatment and/or disposal of contaminated soil or water can be quite expensive.

Maintenance (including administrative and staffing)

- ❑ Develop spill prevention and control plan, provide and document training, conduct inspections of material storage areas, and supply spill kits.
- ❑ Extra time is needed to properly handle and dispose of spills, which results in increased labor costs.

Supplemental Information

Further Detail of the BMP

Reporting

Record keeping and internal reporting represent good operating practices because they can increase the efficiency of the facility and the effectiveness of BMPs. A good record keeping system helps the facility minimize incident recurrence, correctly respond with appropriate cleanup activities, and comply with legal requirements. A record keeping and reporting system should be set up for documenting spills, leaks, and other discharges, including discharges of hazardous substances in reportable quantities. Incident records describe the quality and quantity of non-stormwater discharges to the storm sewer. These records should contain the following information:

- ❑ Date and time of the incident;
- ❑ Weather conditions;
- ❑ Duration of the spill/leak/discharge;

Spill Prevention, Control & Cleanup SC-11

- Cause of the spill/leak/discharge;
- Response procedures implemented;
- Persons notified; and
- Environmental problems associated with the spill/leak/discharge.

Separate record keeping systems should be established to document housekeeping and preventive maintenance inspections, and training activities. All housekeeping and preventive maintenance inspections should be documented. Inspection documentation should contain the following information:

- Date and time the inspection was performed;
- Name of the inspector;
- Items inspected;
- Problems noted;
- Corrective action required; and
- Date corrective action was taken.

Other means to document and record inspection results are field notes, timed and dated photographs, videotapes, and drawings and maps.

Aboveground Tank Leak and Spill Control

Accidental releases of materials from aboveground liquid storage tanks present the potential for contaminating stormwater with many different pollutants. Materials spilled, leaked, or lost from tanks may accumulate in soils or on impervious surfaces and be carried away by stormwater runoff.

The most common causes of unintentional releases are:

- Installation problems;
- Failure of piping systems (pipes, pumps, flanges, couplings, hoses, and valves);
- External corrosion and structural failure;
- Spills and overfills due to operator error; and
- Leaks during pumping of liquids or gases from truck or rail car to a storage tank or vice versa.

Spill Prevention, Control & Cleanup SC-11

Storage of reactive, ignitable, or flammable liquids should comply with the Uniform Fire Code and the National Electric Code. Practices listed below should be employed to enhance the code requirements:

- Tanks should be placed in a designated area.
- Tanks located in areas where firearms are discharged should be encapsulated in concrete or the equivalent.
- Designated areas should be impervious and paved with Portland cement concrete, free of cracks and gaps, in order to contain leaks and spills.
- Liquid materials should be stored in UL approved double walled tanks or surrounded by a curb or dike to provide the volume to contain 10 percent of the volume of all of the containers or 110 percent of the volume of the largest container, whichever is greater. The area inside the curb should slope to a drain.
- For used oil or dangerous waste, a dead-end sump should be installed in the drain.
- All other liquids should be drained to the sanitary sewer if available. The drain must have a positive control such as a lock, valve, or plug to prevent release of contaminated liquids.
- Accumulated stormwater in petroleum storage areas should be passed through an oil/water separator.

Maintenance is critical to preventing leaks and spills. Conduct routine inspections and:

- Check for external corrosion and structural failure.
- Check for spills and overfills due to operator error.
- Check for failure of piping system (pipes, pumps, flanges, coupling, hoses, and valves).
- Check for leaks or spills during pumping of liquids or gases from truck or rail car to a storage facility or vice versa.
- Visually inspect new tank or container installation for loose fittings, poor welding, and improper or poorly fitted gaskets.
- Inspect tank foundations, connections, coatings, and tank walls and piping system. Look for corrosion, leaks, cracks, scratches, and other physical damage that may weaken the tank or container system.
- Frequently relocate accumulated stormwater during the wet season.

Spill Prevention, Control & Cleanup SC-11

- Periodically conduct integrity testing by a qualified professional.

Vehicle Leak and Spill Control

Major spills on roadways and other public areas are generally handled by highly trained Hazmat teams from local fire departments or environmental health departments. The measures listed below pertain to leaks and smaller spills at vehicle maintenance shops.

In addition to implementing the spill prevention, control, and clean up practices above, use the following measures related to specific activities:

Vehicle and Equipment Maintenance

- Perform all vehicle fluid removal or changing inside or under cover to prevent the run-on of stormwater and the runoff of spills.
- Regularly inspect vehicles and equipment for leaks, and repair immediately.
- Check incoming vehicles and equipment (including delivery trucks, and employee and subcontractor vehicles) for leaking oil and fluids. Do not allow leaking vehicles or equipment onsite.
- Always use secondary containment, such as a drain pan or drop cloth, to catch spills or leaks when removing or changing fluids.
- Immediately drain all fluids from wrecked vehicles.
- Store wrecked vehicles or damaged equipment under cover.
- Place drip pans or absorbent materials under heavy equipment when not in use.
- Use absorbent materials on small spills rather than hosing down the spill.
- Remove the adsorbent materials promptly and dispose of properly.
- Promptly transfer used fluids to the proper waste or recycling drums. Don't leave full drip pans or other open containers lying around.
- Oil filters disposed of in trashcans or dumpsters can leak oil and contaminate stormwater. Place the oil filter in a funnel over a waste oil recycling drum to drain excess oil before disposal. Oil filters can also be recycled. Ask your oil supplier or recycler about recycling oil filters.
- Store cracked batteries in a non-leaking secondary container. Do this with all cracked batteries, even if you think all the acid has drained out. If you drop a battery, treat it as if it is cracked. Put it into the containment area until you are sure it is not leaking.

Spill Prevention, Control & Cleanup SC-11

Vehicle and Equipment Fueling

- Design the fueling area to prevent the run-on of stormwater and the runoff of spills:

- Cover fueling area if possible.

- Use a perimeter drain or slope pavement inward with drainage to a sump.

- Pave fueling area with concrete rather than asphalt.

- If dead-end sump is not used to collect spills, install an oil/water separator.
- Install vapor recovery nozzles to help control drips as well as air pollution.
- Discourage “topping-off” of fuel tanks.
- Use secondary containment when transferring fuel from the tank truck to the fuel tank.
- Use absorbent materials on small spills and general cleaning rather than hosing down the area. Remove the absorbent materials promptly.
- Carry out all Federal and State requirements regarding underground storage tanks, or install above ground tanks.
- Do not use mobile fueling of mobile industrial equipment around the facility; rather, transport the equipment to designated fueling areas.
- Keep your Spill Prevention Control and Countermeasure (SPCC) Plan up-to-date.
- Train employees in proper fueling and cleanup procedures.

Industrial Spill Prevention Response

For the purposes of developing a spill prevention and response program to meet the stormwater regulations, facility managers should use information provided in this fact sheet and the spill prevention/response portions of the fact sheets in this handbook, for specific activities.

The program should:

- Integrate with existing emergency response/hazardous materials programs (e.g., Fire Department).
- Develop procedures to prevent/mitigate spills to storm drain systems.
- Identify responsible departments.

Spill Prevention, Control & Cleanup SC-11

- Develop and standardize reporting procedures, containment, storage, and disposal activities, documentation, and follow-up procedures.
- Address spills at municipal facilities, as well as public areas.
- Provide training concerning spill prevention, response and cleanup to all appropriate personnel.

References and Resources

California's Nonpoint Source Program Plan. <http://www.swrcb.ca.gov/nps/index.html>.

Clark County Storm Water Pollution Control Manual. Available online at:
<http://www.co.clark.wa.us/pubworks/bmpman.pdf>.

King County Storm Water Pollution Control Manual. Available online at:
<http://dnr.metrokc.gov/wlr/dss/spcm.htm>.

Orange County Stormwater Program, Best Management Practices for Industrial/Commercial Business Activities. Available online at:
<http://ocwatersheds.com/documents/bmp/industrialcommercialbusinessesactivities>

Santa Clara Valley Urban Runoff Pollution Prevention Program.
<http://www.scvurppp.org>.

The Stormwater Managers Resource Center. <http://www.stormwatercenter.net/>.

Description

Improper storage and handling of solid wastes can allow toxic compounds, oils and greases, heavy metals, nutrients, suspended solids, and other pollutants to enter stormwater runoff. The discharge of pollutants to stormwater from waste handling and disposal can be prevented and reduced by tracking waste generation, storage, and disposal; reducing waste generation and disposal through source reduction, reuse, and recycling; and preventing run-on and runoff.

Approach

Reduce potential for pollutant discharge through source control pollution prevention and BMP implementation. Successful implementation depends on effective training of employees on applicable BMPs and general pollution prevention strategies and objectives.

General Pollution Prevention Protocols

- Accomplish reduction in the amount of waste generated using the following source controls:
 - ✓ Production planning and sequencing;
 - ✓ Process or equipment modification;
 - ✓ Raw material substitution or elimination;
 - ✓ Loss prevention and housekeeping;
 - ✓ Waste segregation and separation; and
 - ✓ Close loop recycling.
- Establish a material tracking system to increase awareness about material usage. This may reduce spills and minimize contamination, thus reducing the amount of waste produced.
- Recycle materials whenever possible.

Objectives

- Cover
- Contain
- Educate
- Reduce/Minimize
- Product Substitution

Targeted Constituents

Sediment	
Nutrients	
Trash	
Metals	✓
Bacteria	✓
Oil and Grease	✓
Organics	✓

Minimum BMPs Covered

 Good Housekeeping	✓
 Preventative Maintenance	✓
 Spill and Leak Prevention and Response	✓
 Material Handling & Waste Management	✓
 Erosion and Sediment Controls	
 Employee Training Program	✓
 Quality Assurance Record Keeping	✓



- Use the entire product before disposing of the container.
- To the extent possible, store wastes under cover or indoors after ensuring all safety concerns such as fire hazard and ventilation are addressed.
- Provide containers for each waste stream at each work station. Allow time after shift to clean area.



Good Housekeeping

- Cover storage containers with leak proof lids or some other means. If waste is not in containers, cover all waste piles (plastic tarps are acceptable coverage) and prevent stormwater run-on and runoff with a berm. The waste containers or piles must be covered except when in use.
- Use drip pans or absorbent materials whenever grease containers are emptied by vacuum trucks or other means. Grease cannot be left on the ground. Collected grease must be properly disposed of as garbage.
- Dispose of rinse and wash water from cleaning waste containers into a sanitary sewer if allowed by the local sewer authority. Do not discharge wash water to the street or storm drain. Clean in a designated wash area that drains to a clarifier.
- Transfer waste from damaged containers into safe containers.
- Take special care when loading or unloading wastes to minimize losses. Loading systems can be used to minimize spills and fugitive emission losses such as dust or mist. Vacuum transfer systems can minimize waste loss.
- Keep the waste management area clean at all times by sweeping and cleaning up spills immediately.
- Use dry methods when possible (e.g., sweeping, use of absorbents) when cleaning around restaurant/food handling dumpster areas. If water must be used after sweeping/using absorbents, collect water and discharge through grease interceptor to the sewer.
- Stencil or demarcate storm drains on the facility's property with prohibitive message regarding waste disposal.
- Cover waste piles with temporary covering material such as reinforced tarpaulin, polyethylene, polyurethane, polypropylene or hypalon.
- If possible, move the activity indoor after ensuring all safety concerns such as fire hazard and ventilation are addressed.



Preventative Maintenance

- Prevent stormwater run-on from entering the waste management area by enclosing the area or building a berm around the area.
- Prevent waste materials from directly contacting rain.

- ❑ Cover waste piles with temporary covering material such as reinforced tarpaulin, polyethylene, polyurethane, polypropylene or hypalon.
- ❑ Cover the area with a permanent roof if feasible.
- ❑ Cover dumpsters to prevent rain from washing waste out of holes or cracks in the bottom of the dumpster.
- ❑ Check waste containers weekly for leaks and to ensure that lids are on tightly. Replace any that are leaking, corroded, or otherwise deteriorating.
- ❑ Sweep and clean the waste management area regularly. Use dry methods when possible (e.g., sweeping, vacuuming, use of absorbents) when cleaning around restaurant/food handling dumpster areas. If water must be used after sweeping/using absorbents, collect water and discharge through grease interceptor to the sewer.
- ❑ Inspect and replace faulty pumps or hoses regularly to minimize the potential of releases and spills.
- ❑ Repair leaking equipment including valves, lines, seals, or pumps promptly.



Spill Response and Prevention Procedures

- ❑ Keep your spill prevention and plan up-to-date.
- ❑ Have an emergency plan, equipment and trained personnel ready at all times to deal immediately with major spills.
- ❑ Collect all spilled liquids and properly dispose of them.
- ❑ Store and maintain appropriate spill cleanup materials in a location known to all near the designated wash area.
- ❑ Ensure that vehicles transporting waste have spill prevention equipment that can prevent spills during transport. Spill prevention equipment includes:
 - ✓ Vehicles equipped with baffles for liquid waste; and
 - ✓ Trucks with sealed gates and spill guards for solid waste.



Material Handling and Waste Management

Litter Control

- ❑ Post “No Littering” signs and enforce anti-litter laws.
- ❑ Provide a sufficient number of litter receptacles for the facility.
- ❑ Clean out and cover litter receptacles frequently to prevent spillage.

Waste Collection

- ❑ Keep waste collection areas clean.

- Inspect solid waste containers for structural damage regularly. Repair or replace damaged containers as necessary.
- Secure solid waste containers; containers must be closed tightly when not in use.
- Do not fill waste containers with washout water or any other liquid.
- Ensure that only appropriate solid wastes are added to the solid waste container. Certain wastes such as hazardous wastes, appliances, fluorescent lamps, pesticides, etc., may not be disposed of in solid waste containers (see chemical/ hazardous waste collection section below).
- Do not mix wastes; this can cause chemical reactions, make recycling impossible, and complicate disposal. Affix labels to all waste containers.

Chemical/Hazardous Wastes

- Select designated hazardous waste collection areas on-site.
- Store hazardous materials and wastes in covered containers and protect them from vandalism.
- Place hazardous waste containers in secondary containment.
- Make sure that hazardous waste is collected, removed, and disposed of only at authorized disposal areas.
- Hazardous waste cannot be reused or recycled; it must be disposed of by a licensed hazardous waste hauler.



Employee Training Program

- Educate employees about pollution prevention measures and goals.
- Train employees how to properly handle and dispose of waste using the source control BMPs described above.
- Train employees and subcontractors in proper hazardous waste management.
- Use a training log or similar method to document training.
- Ensure that employees are familiar with the site's spill control plan and/or proper spill cleanup procedures.



Quality Assurance and Record Keeping

- Keep accurate maintenance logs that document minimum BMP activities performed for waste handling and disposal, types and quantities of waste disposed of, and any improvement actions.
- Keep accurate logs of spill response actions that document what was spilled, how it was cleaned up, and how the waste was disposed.

- Establish procedures to complete logs and file them in the central office.

Potential Capital Facility Costs and Operation & Maintenance Requirements

Facilities

- Capital costs will vary substantially depending on the size of the facility and the types of waste handled. Significant capital costs may be associated with reducing wastes by modifying processes or implementing closed-loop recycling.
- Many facilities will already have indoor covered areas where waste materials will be stored and will require no additional capital expenditures for providing cover.
- If outdoor storage of wastes is required, construction of berms or other means to prevent stormwater run-on and runoff may require appropriate constructed systems for containment.
- Capital investments will likely be required at some sites if adequate cover and containment facilities do not exist and can vary significantly depending upon site conditions.

Maintenance

- Check waste containers weekly for leaks and to ensure that lids are on tightly. Replace any that are leaking, corroded, or otherwise deteriorating.
- Sweep and clean the waste management area regularly. Use dry methods when possible (e.g., sweeping, use of absorbents) when cleaning around restaurant/food handling dumpster areas. If water must be used after sweeping/using absorbents, collect water and discharge through grease interceptor to the sewer.
- Inspect and replace faulty pumps or hoses regularly to minimize the potential of releases and spills.
- Repair leaking equipment including valves, lines, seals, or pumps promptly.

References and Resources

Minnesota Pollution Control Agency, *Industrial Stormwater Best Management Practices Guidebook*. Available online at: <http://www.pca.state.mn.us/index.php/view-document.html?gid=10557>.

New Jersey Department of Environmental Protection, 2013. *Basic Industrial Stormwater General Permit Guidance Document NJPDES General Permit No NJ0088315*, Revised. Available online at: http://www.nj.gov/dep/dwq/pdf/5G2_guidance_color.pdf.

Orange County Stormwater Program, *Best Management Practices for Industrial/Commercial Business Activities*. Available online at: <http://ocwatersheds.com/documents/bmp/industrialcommercialbusinessesactivities>

Oregon Department of Environmental Quality, 2013. *Industrial Stormwater Best Management Practices Manual- BMP 26 Fueling and Liquid Loading/Unloading Operations*. Available online at:
<http://www.deq.state.or.us/wq/wqpermit/docs/IndBMP021413.pdf>.

Sacramento Stormwater Management Program. *Best Management Practices for Industrial Storm Water Pollution Control*. Available online at:
<http://www.msa.saccounty.net/sactostormwater/documents/guides/industrial-BMP-manual.pdf>.

Sacramento County Environmental Management Stormwater Program: Best Management Practices. Available online at:
<http://www.emd.saccounty.net/EnvHealth/Stormwater/Stormwater-BMPs.html>.

Santa Clara Valley Urban Runoff Pollution Prevention Program. <http://www.scvurppp-w2k.com/>

US EPA. National Pollutant Discharge Elimination System – Industrial Fact Sheet Series for Activities Covered by EPA’s Multi Sector General Permit. Available online at:
<http://cfpub.epa.gov/npdes/stormwater/swsectors.cfm>.



Description

Stormwater runoff from building and grounds maintenance activities can be contaminated with toxic hydrocarbons in solvents, fertilizers and pesticides, suspended solids, heavy metals, abnormal pH, and oils and greases. Utilizing the protocols in this fact sheet will prevent or reduce the discharge of pollutants to stormwater from building and grounds maintenance activities by washing and cleaning up with as little water as possible, following good landscape management practices, preventing and cleaning up spills immediately, keeping debris from entering the storm drains, and maintaining the stormwater collection system.

Approach

Reduce potential for pollutant discharge through source control pollution prevention and BMP implementation. Successful implementation depends on effective training of employees on applicable BMPs and general pollution prevention strategies and objectives.

Pollution Prevention

- Switch to non-toxic chemicals for maintenance when possible.
- Choose cleaning agents that can be recycled.
- Encourage proper lawn management and landscaping, including use of native vegetation.

Objectives

- Cover
- Contain
- Educate
- Reduce/Minimize
- Product Substitution

Targeted Constituents

Sediment	✓
Nutrients	✓
Trash	
Metals	✓
Bacteria	✓
Oil and Grease	
Organics	



SC-41 Building & Grounds Maintenance

- Encourage use of Integrated Pest Management techniques for pest control.
- Encourage proper onsite recycling of yard trimmings.
- Recycle residual paints, solvents, lumber, and other material as much as possible.

Suggested Protocols

Pressure Washing of Buildings, Rooftops, and Other Large Objects

- In situations where soaps or detergents are used and the surrounding area is paved, pressure washers must use a water collection device that enables collection of wash water and associated solids. A sump pump, wet vacuum or similarly effective device must be used to collect the runoff and loose materials. The collected runoff and solids must be disposed of properly.
- If soaps or detergents are not used, and the surrounding area is paved, wash runoff does not have to be collected but must be screened. Pressure washers must use filter fabric or some other type of screen on the ground and/or in the catch basin to trap the particles in wash water runoff.
- If you are pressure washing on a grassed area (with or without soap), runoff must be dispersed as sheet flow as much as possible, rather than as a concentrated stream. The wash runoff must remain on the grass and not drain to pavement.

Landscaping Activities

- Dispose of grass clippings, leaves, sticks, or other collected vegetation as garbage, or by composting. Do not dispose of collected vegetation into waterways or storm drainage systems.
- Use mulch or other erosion control measures on exposed soils.

Building Repair, Remodeling, and Construction

- Do not dump any toxic substance or liquid waste on the pavement, the ground, or toward a storm drain.
- Use ground or drop cloths underneath outdoor painting, scraping, and sandblasting work, and properly dispose of collected material daily.
- Use a ground cloth or oversized tub for activities such as paint mixing and tool cleaning.
- Clean paintbrushes and tools covered with water-based paints in sinks connected to sanitary sewers or in portable containers that can be dumped into a sanitary sewer drain. Brushes and tools covered with non-water-based paints, finishes, or other materials must be cleaned in a manner that enables collection of used solvents (e.g., paint thinner, turpentine, etc.) for recycling or proper disposal.
- Use a storm drain cover, filter fabric, or similarly effective runoff control mechanism if dust, grit, wash water, or other pollutants may escape the work area and enter a catch basin. This is particularly necessary on rainy days. The containment device(s) must be in place at the beginning of the work day, and accumulated dirty runoff and solids must be collected and disposed of before removing the containment device(s) at the end of the work day.

- If you need to de-water an excavation site, you may need to filter the water before discharging to a catch basin or off-site. If directed off-site, you should direct the water through hay bales and filter fabric or use other sediment filters or traps.
- Store toxic material under cover during precipitation events and when not in use. A cover would include tarps or other temporary cover material.

Mowing, Trimming, and Planting

- Dispose of leaves, sticks, or other collected vegetation as garbage, by composting or at a permitted landfill. Do not dispose of collected vegetation into waterways or storm drainage systems.
- Use mulch or other erosion control measures when soils are exposed.
- Place temporarily stockpiled material away from watercourses and drain inlets, and berm or cover stockpiles to prevent material releases to the storm drain system.
- Consider an alternative approach when bailing out muddy water: do not put it in the storm drain; pour over landscaped areas.
- Use hand weeding where practical.

Fertilizer and Pesticide Management

- Follow all federal, state, and local laws and regulations governing the use, storage, and disposal of fertilizers and pesticides and training of applicators and pest control advisors.
- Use less toxic pesticides that will do the job when applicable. Avoid use of copper-based pesticides if possible.
- Do not use pesticides if rain is expected.
- Do not mix or prepare pesticides for application near storm drains.
- Use the minimum amount needed for the job.
- Calibrate fertilizer distributors to avoid excessive application.
- Employ techniques to minimize off-target application (e.g., spray drift) of pesticides, including consideration of alternative application techniques.
- Apply pesticides only when wind speeds are low.
- Fertilizers should be worked into the soil rather than dumped or broadcast onto the surface.
- Irrigate slowly to prevent runoff and then only as much as is needed.
- Clean pavement and sidewalk if fertilizer is spilled on these surfaces before applying irrigation water.
- Dispose of empty pesticide containers according to the instructions on the container label.

SC-41 Building & Grounds Maintenance

- Use up the pesticides. Rinse containers, and use rinse water as product. Dispose of unused pesticide as hazardous waste.
- Implement storage requirements for pesticide products with guidance from the local fire department and County Agricultural Commissioner. Provide secondary containment for pesticides.

Inspection

- Inspect irrigation system periodically to ensure that the right amount of water is being applied and that excessive runoff is not occurring. Minimize excess watering and repair leaks in the irrigation system as soon as they are observed.

Training

- Educate and train employees on pesticide use and in pesticide application techniques to prevent pollution.
- Train employees and contractors in proper techniques for spill containment and cleanup.
- Be sure the frequency of training takes into account the complexity of the operations and the nature of the staff.

Spill Response and Prevention

- Keep your Spill Prevention Control and Countermeasure (SPCC) Plan up-to-date.
- Place a stockpile of spill cleanup materials, such as brooms, dustpans, and vacuum sweepers (if desired) near the storage area where it will be readily accessible.
- Have employees trained in spill containment and cleanup present during the loading/unloading of dangerous wastes, liquid chemicals, or other materials.
- Familiarize employees with the Spill Prevention Control and Countermeasure Plan.
- Clean up spills immediately.

Other Considerations

Alternative pest/weed controls may not be available, suitable, or effective in many cases.

Requirements

Costs

- Cost will vary depending on the type and size of facility.
- Overall costs should be low in comparison to other BMPs.

Maintenance

Sweep paved areas regularly to collect loose particles. Wipe up spills with rags and other absorbent material immediately, do not hose down the area to a storm drain.

Supplemental Information

Further Detail of the BMP

Fire Sprinkler Line Flushing

Building fire sprinkler line flushing may be a source of non-stormwater runoff pollution. The water entering the system is usually potable water, though in some areas it may be non-potable reclaimed wastewater. There are subsequent factors that may drastically reduce the quality of the water in such systems. Black iron pipe is usually used since it is cheaper than potable piping, but it is subject to rusting and results in lower quality water. Initially, the black iron pipe has an oil coating to protect it from rusting between manufacture and installation; this will contaminate the water from the first flush but not from subsequent flushes. Nitrates, poly-phosphates and other corrosion inhibitors, as well as fire suppressants and antifreeze may be added to the sprinkler water system. Water generally remains in the sprinkler system a long time (typically a year) and between flushes may accumulate iron, manganese, lead, copper, nickel, and zinc. The water generally becomes anoxic and contains living and dead bacteria and breakdown products from chlorination. This may result in a significant BOD problem and the water often smells. Consequently dispose fire sprinkler line flush water into the sanitary sewer. Do not allow discharge to storm drain or infiltration due to potential high levels of pollutants in fire sprinkler line water.

References and Resources

California's Nonpoint Source Program Plan <http://www.swrcb.ca.gov/nps/index.html>

Clark County Storm Water Pollution Control Manual
<http://www.co.clark.wa.us/pubworks/bmpman.pdf>

King County Storm Water Pollution Control Manual <http://dnr.metrokc.gov/wlr/dss/spcm.htm>

Mobile Cleaners Pilot Program: Final Report. 1997. Bay Area Stormwater Management Agencies Association (BASMAA). <http://www.basmaa.org/>

Pollution from Surface Cleaning Folder. 1996. Bay Area Stormwater Management Agencies Association (BASMAA). <http://www.basmaa.org/>

Santa Clara Valley Urban Runoff Pollution Prevention Program <http://www.scvurppp.org>

The Storm Water Managers Resource Center <http://www.stormwatercenter.net/>

Parking/Storage Area Maintenance SC-43



Description

Parking lots and storage areas can contribute a number of substances, such as trash, suspended solids, hydrocarbons, oil and grease, and heavy metals that can enter receiving waters through stormwater runoff or non-stormwater discharges. The protocols in this fact sheet are intended to prevent or reduce the discharge of pollutants from parking/storage areas and include using good housekeeping practices, following appropriate cleaning BMPs, and training employees.

Approach

The goal of this program is to ensure stormwater pollution prevention practices are considered when conducting activities on or around parking areas and storage areas to reduce potential for pollutant discharge to receiving waters. Successful implementation depends on effective training of employees on applicable BMPs and general pollution prevention strategies and objectives.

Pollution Prevention

- Encourage alternative designs and maintenance strategies for impervious parking lots. (See New Development and Redevelopment BMP Handbook)
- Keep accurate maintenance logs to evaluate BMP implementation.

Objectives

- Cover
- Contain
- Educate
- Reduce/Minimize
- Product Substitution

Targeted Constituents

Sediment	✓
Nutrients	
Trash	✓
Metals	✓
Bacteria	
Oil and Grease	✓
Organics	✓



SC-43 Parking/Storage Area Maintenance

Suggested Protocols

General

- Keep the parking and storage areas clean and orderly. Remove debris in a timely fashion.
- Allow sheet runoff to flow into biofilters (vegetated strip and swale) and/or infiltration devices.
- Utilize sand filters or oleophilic collectors for oily waste in low quantities.
- Arrange rooftop drains to prevent drainage directly onto paved surfaces.
- Design lot to include semi-permeable hardscape.
- Discharge soapy water remaining in mop or wash buckets to the sanitary sewer through a sink, toilet, clean-out, or wash area with drain.

Controlling Litter

- Post “No Littering” signs and enforce anti-litter laws.
- Provide an adequate number of litter receptacles.
- Clean out and cover litter receptacles frequently to prevent spillage.
- Provide trash receptacles in parking lots to discourage litter.
- Routinely sweep, shovel, and dispose of litter in the trash.

Surface Cleaning

- Use dry cleaning methods (e.g., sweeping, vacuuming) to prevent the discharge of pollutants into the stormwater conveyance system if possible.
- Establish frequency of public parking lot sweeping based on usage and field observations of waste accumulation.
- Sweep all parking lots at least once before the onset of the wet season.
- Follow the procedures below if water is used to clean surfaces:
 - Block the storm drain or contain runoff.
 - Collect and pump wash water to the sanitary sewer or discharge to a pervious surface. Do not allow wash water to enter storm drains.
 - Dispose of parking lot sweeping debris and dirt at a landfill.
- Follow the procedures below when cleaning heavy oily deposits:
 - Clean oily spots with absorbent materials.
 - Use a screen or filter fabric over inlet, then wash surfaces.

Parking/Storage Area Maintenance SC-43

- Do not allow discharges to the storm drain.
- Vacuum/pump discharges to a tank or discharge to sanitary sewer.
- Appropriately dispose of spilled materials and absorbents.

Surface Repair

- Preheat, transfer or load hot bituminous material away from storm drain inlets.
- Apply concrete, asphalt, and seal coat during dry weather to prevent contamination from contacting stormwater runoff.
- Cover and seal nearby storm drain inlets where applicable (with waterproof material or mesh) and manholes before applying seal coat, slurry seal, etc. Leave covers in place until job is complete and all water from emulsified oil sealants has drained or evaporated. Clean any debris from these covered manholes and drains for proper disposal.
- Use only as much water as necessary for dust control, to avoid runoff.
- Catch drips from paving equipment that is not in use with pans or absorbent material placed under the machines. Dispose of collected material and absorbents properly.

Inspection

- Have designated personnel conduct inspections of parking facilities and stormwater conveyance systems associated with parking facilities on a regular basis.
- Inspect cleaning equipment/sweepers for leaks on a regular basis.

Training

- Provide regular training to field employees and/or contractors regarding cleaning of paved areas and proper operation of equipment.
- Train employees and contractors in proper techniques for spill containment and cleanup.

Spill Response and Prevention

- Keep your Spill Prevention Control and Countermeasure (SPCC) Plan up-to-date.
- Place a stockpile of spill cleanup materials where it will be readily accessible or at a central location.
- Clean up fluid spills immediately with absorbent rags or material.
- Dispose of spilled material and absorbents properly.

Other Considerations

Limitations related to sweeping activities at large parking facilities may include high equipment costs, the need for sweeper operator training, and the inability of current sweeper technology to remove oil and grease.

SC-43 Parking/Storage Area Maintenance

Requirements

Costs

Cleaning/sweeping costs can be quite large. Construction and maintenance of stormwater structural controls can be quite expensive as well.

Maintenance

- Sweep parking lot regularly to minimize cleaning with water.
- Clean out oil/water/sand separators regularly, especially after heavy storms.
- Clean parking facilities regularly to prevent accumulated wastes and pollutants from being discharged into conveyance systems during rainy conditions.

Supplemental Information

Further Detail of the BMP

Surface Repair

Apply concrete, asphalt, and seal coat during dry weather to prevent contamination from contacting stormwater runoff. Where applicable, cover and seal nearby storm drain inlets (with waterproof material or mesh) and manholes before applying seal coat, slurry seal, etc. Leave covers in place until job is complete and all water from emulsified oil sealants has drained or evaporated. Clean any debris from these covered manholes and drains for proper disposal. Only use only as much water as is necessary for dust control to avoid runoff.

References and Resources

California's Nonpoint Source Program Plan <http://www.swrcb.ca.gov/nps/index.html>

Clark County Storm Water Pollution Control Manual
<http://www.co.clark.wa.us/pubworks/bmpman.pdf>

King County Storm Water Pollution Control Manual <http://dnr.metrokc.gov/wlr/dss/spcm.htm>

Pollution from Surface Cleaning Folder. 1996. Bay Area Stormwater Management Agencies Association (BASMAA). <http://www.basmaa.org/>

Oregon Association of Clean Water Agencies. Oregon Municipal Stormwater Toolbox for Maintenance Practices. June 1998.

Santa Clara Valley Urban Runoff Pollution Prevention Program <http://www.scvurppp.org>

The Storm Water Managers Resource Center <http://www.stormwatercenter.net/>



Objectives

- Cover
- Contain
- Educate
- Reduce/Minimize

Description

As a consequence of its function, the stormwater conveyance system collects and transports urban runoff and stormwater that may contain certain pollutants. The protocols in this fact sheet are intended to reduce pollutants reaching receiving waters through proper conveyance system operation and maintenance.

Approach

Pollution Prevention

Maintain catch basins, stormwater inlets, and other stormwater conveyance structures on a regular basis to remove pollutants, reduce high pollutant concentrations during the first flush of storms, prevent clogging of the downstream conveyance system, restore catch basins' sediment trapping capacity, and ensure the system functions properly hydraulically to avoid flooding.

Suggested Protocols

Catch Basins/Inlet Structures

- Staff should regularly inspect facilities to ensure compliance with the following:
 - Immediate repair of any deterioration threatening structural integrity.
 - Cleaning before the sump is 40% full. Catch basins should be cleaned as frequently as needed to meet this standard.
 - Stenciling of catch basins and inlets (see SC34 Waste Handling and Disposal).

Targeted Constituents

Sediment	✓
Nutrients	
Trash	✓
Metals	
Bacteria	✓
Oil and Grease	
Organics	



- Clean catch basins, storm drain inlets, and other conveyance structures before the wet season to remove sediments and debris accumulated during the summer.
- Conduct inspections more frequently during the wet season for problem areas where sediment or trash accumulates more often. Clean and repair as needed.
- Keep accurate logs of the number of catch basins cleaned.
- Store wastes collected from cleaning activities of the drainage system in appropriate containers or temporary storage sites in a manner that prevents discharge to the storm drain.
- Dewater the wastes if necessary with outflow into the sanitary sewer if permitted. Water should be treated with an appropriate filtering device prior to discharge to the sanitary sewer. If discharge to the sanitary sewer is not allowed, water should be pumped or vacuumed to a tank and properly disposed. Do not dewater near a storm drain or stream.

Storm Drain Conveyance System

- Locate reaches of storm drain with deposit problems and develop a flushing schedule that keeps the pipe clear of excessive buildup.
- Collect and pump flushed effluent to the sanitary sewer for treatment whenever possible.

Pump Stations

- Clean all storm drain pump stations prior to the wet season to remove silt and trash.
- Do not allow discharge to reach the storm drain system when cleaning a storm drain pump station or other facility.
- Conduct routine maintenance at each pump station.
- Inspect, clean, and repair as necessary all outlet structures prior to the wet season.

Open Channel

- Modify storm channel characteristics to improve channel hydraulics, increase pollutant removals, and enhance channel/creek aesthetic and habitat value.
- Conduct channel modification/improvement in accordance with existing laws. Any person, government agency, or public utility proposing an activity that will change the natural (emphasis added) state of any river, stream, or lake in California, must enter into a Stream or Lake Alteration Agreement with the Department of Fish and Game. The developer-applicant should also contact local governments (city, county, special districts), other state agencies (SWRCB, RWQCB, Department of Forestry, Department of Water Resources), and Federal Corps of Engineers and USFWS.

Illicit Connections and Discharges

- Look for evidence of illegal discharges or illicit connections during routine maintenance of conveyance system and drainage structures:
 - Is there evidence of spills such as paints, discoloring, etc?

- Are there any odors associated with the drainage system?
- Record locations of apparent illegal discharges/illicit connections?
- Track flows back to potential dischargers and conduct aboveground inspections. This can be done through visual inspection of upgradient manholes or alternate techniques including zinc chloride smoke testing, fluorometric dye testing, physical inspection testing, or television camera inspection.
- Eliminate the discharge once the origin of flow is established.
- Stencil or demarcate storm drains, where applicable, to prevent illegal disposal of pollutants. Storm drain inlets should have messages such as “Dump No Waste Drains to Stream” stenciled next to them to warn against ignorant or intentional dumping of pollutants into the storm drainage system.
- Refer to fact sheet SC-10 Non-Stormwater Discharges.

Illegal Dumping

- Inspect and clean up hot spots and other storm drainage areas regularly where illegal dumping and disposal occurs.
- Establish a system for tracking incidents. The system should be designed to identify the following:
 - Illegal dumping hot spots
 - Types and quantities (in some cases) of wastes
 - Patterns in time of occurrence (time of day/night, month, or year)
 - Mode of dumping (abandoned containers, “midnight dumping” from moving vehicles, direct dumping of materials, accidents/spills)
 - Responsible parties
- Post “No Dumping” signs in problem areas with a phone number for reporting dumping and disposal. Signs should also indicate fines and penalties for illegal dumping.
- Refer to fact sheet SC-10 Non-Stormwater Discharges.

Training

- Train crews in proper maintenance activities, including record keeping and disposal.
- Allow only properly trained individuals to handle hazardous materials/wastes.
- Have staff involved in detection and removal of illicit connections trained in the following:
 - OSHA-required Health and Safety Training (29 CFR 1910.120) plus annual refresher training (as needed).

- OSHA Confined Space Entry training (Cal-OSHA Confined Space, Title 8 and Federal OSHA 29 CFR 1910.146).
- Procedural training (field screening, sampling, smoke/dye testing, TV inspection).

Spill Response and Prevention

- Investigate all reports of spills, leaks, and/or illegal dumping promptly.
- Clean up all spills and leaks using “dry” methods (with absorbent materials and/or rags) or dig up, remove, and properly dispose of contaminated soil.
- Refer to fact sheet SC-11 Spill Prevention, Control, and Cleanup.

Other Considerations (Limitations and Regulations)

- Clean-up activities may create a slight disturbance for local aquatic species. Access to items and material on private property may be limited. Trade-offs may exist between channel hydraulics and water quality/riparian habitat. If storm channels or basins are recognized as wetlands, many activities, including maintenance, may be subject to regulation and permitting.
- Storm drain flushing is most effective in small diameter pipes (36-inch diameter pipe or less, depending on water supply and sediment collection capacity). Other considerations associated with storm drain flushing may include the availability of a water source, finding a downstream area to collect sediments, liquid/sediment disposal, and prohibition against disposal of flushed effluent to sanitary sewer in some areas.
- Regulations may include adoption of substantial penalties for illegal dumping and disposal.
- Local municipal codes may include sections prohibiting discharge of soil, debris, refuse, hazardous wastes, and other pollutants into the storm drain system.

Requirements***Costs***

- An aggressive catch basin cleaning program could require a significant capital and O&M budget.
- The elimination of illegal dumping is dependent on the availability, convenience, and cost of alternative means of disposal. The primary cost is for staff time. Cost depends on how aggressively a program is implemented. Other cost considerations for an illegal dumping program include:
 - Purchase and installation of signs.
 - Rental of vehicle(s) to haul illegally-disposed items and material to landfills.
 - Rental of heavy equipment to remove larger items (e.g., car bodies) from channels.
 - Purchase of landfill space to dispose of illegally-dumped items and material.

- Methods used for illicit connection detection (smoke testing, dye testing, visual inspection, and flow monitoring) can be costly and time-consuming. Site-specific factors, such as the level of impervious area, the density and ages of buildings, and type of land use will determine the level of investigation necessary.

Maintenance

- Two-person teams may be required to clean catch basins with vacuor trucks.
- Teams of at least two people plus administrative personnel are required to identify illicit discharges, depending on the complexity of the storm sewer system.
- Arrangements must be made for proper disposal of collected wastes.
- Technical staff are required to detect and investigate illegal dumping violations.

Supplemental Information

Further Detail of the BMP

Storm Drain Flushing

Flushing is a common maintenance activity used to improve pipe hydraulics and to remove pollutants in storm drainage systems. Flushing may be designed to hydraulically convey accumulated material to strategic locations, such as an open channel, another point where flushing will be initiated, or the sanitary sewer and the treatment facilities, thus preventing resuspension and overflow of a portion of the solids during storm events. Flushing prevents “plug flow” discharges of concentrated pollutant loadings and sediments. Deposits can hinder the designed conveyance capacity of the storm drain system and potentially cause backwater conditions in severe cases of clogging.

Storm drain flushing usually takes place along segments of pipe with grades that are too flat to maintain adequate velocity to keep particles in suspension. An upstream manhole is selected to place an inflatable device that temporarily plugs the pipe. Further upstream, water is pumped into the line to create a flushing wave. When the upstream reach of pipe is sufficiently full to cause a flushing wave, the inflated device is rapidly deflated with the assistance of a vacuum pump, thereby releasing the backed up water and resulting in the cleaning of the storm drain segment.

To further reduce impacts of stormwater pollution, a second inflatable device placed well downstream may be used to recollect the water after the force of the flushing wave has dissipated. A pump may then be used to transfer the water and accumulated material to the sanitary sewer for treatment. In some cases, an interceptor structure may be more practical or required to recollect the flushed waters.

It has been found that cleansing efficiency of periodic flush waves is dependent upon flush volume, flush discharge rate, sewer slope, sewer length, sewer flow rate, sewer diameter, and population density. As a rule of thumb, the length of line to be flushed should not exceed 700 feet. At this maximum recommended length, the percent removal efficiency ranges between 65-75% for organics and 55-65% for dry weather grit/inorganic material. The percent removal efficiency drops rapidly beyond that. Water is commonly supplied by a water truck, but fire hydrants can also supply water. To make the best use of water, it is recommended that reclaimed water be used or that fire hydrant line flushing coincide with storm sewer flushing.

SC-44 Drainage System Maintenance

References and Resources

California's Nonpoint Source Program Plan <http://www.swrcb.ca.gov/nps/index.html>

Clark County Storm Water Pollution Control Manual
<http://www.co.clark.wa.us/pubworks/bmpman.pdf>

Ferguson, B.K. 1991. Urban Stream Reclamation, p. 324-322, Journal of Soil and Water Conservation.

King County Storm Water Pollution Control Manual <http://dnr.metrokc.gov/wlr/dss/spcm.htm>

Oregon Association of Clean Water Agencies. Oregon Municipal Stormwater Toolbox for Maintenance Practices. June 1998.

Santa Clara Valley Urban Runoff Pollution Prevention Program <http://www.scvurppp.org>

The Storm Water Managers Resource Center <http://www.stormwatercenter.net>

United States Environmental Protection Agency (USEPA). 2002. Pollution Prevention/Good Housekeeping for Municipal Operations Storm Drain System Cleaning. On line:
http://www.epa.gov/npdes/menuofbmps/poll_16.htm

Site Design & Landscape Planning SD-10



Design Objectives

- Maximize Infiltration
 - Provide Retention
 - Slow Runoff
 - Minimize Impervious Land Coverage
 - Prohibit Dumping of Improper Materials
 - Contain Pollutants
 - Collect and Convey
-

Description

Each project site possesses unique topographic, hydrologic, and vegetative features, some of which are more suitable for development than others. Integrating and incorporating appropriate landscape planning methodologies into the project design is the most effective action that can be done to minimize surface and groundwater contamination from stormwater.

Approach

Landscape planning should couple consideration of land suitability for urban uses with consideration of community goals and projected growth. Project plan designs should conserve natural areas to the extent possible, maximize natural water storage and infiltration opportunities, and protect slopes and channels.

Suitable Applications

Appropriate applications include residential, commercial and industrial areas planned for development or redevelopment.

Design Considerations

Design requirements for site design and landscapes planning should conform to applicable standards and specifications of agencies with jurisdiction and be consistent with applicable General Plan and Local Area Plan policies.



SD-10 Site Design & Landscape Planning

Designing New Installations

Begin the development of a plan for the landscape unit with attention to the following general principles:

- Formulate the plan on the basis of clearly articulated community goals. Carefully identify conflicts and choices between retaining and protecting desired resources and community growth.
- Map and assess land suitability for urban uses. Include the following landscape features in the assessment: wooded land, open unwooded land, steep slopes, erosion-prone soils, foundation suitability, soil suitability for waste disposal, aquifers, aquifer recharge areas, wetlands, floodplains, surface waters, agricultural lands, and various categories of urban land use. When appropriate, the assessment can highlight outstanding local or regional resources that the community determines should be protected (e.g., a scenic area, recreational area, threatened species habitat, farmland, fish run). Mapping and assessment should recognize not only these resources but also additional areas needed for their sustenance.

Project plan designs should conserve natural areas to the extent possible, maximize natural water storage and infiltration opportunities, and protect slopes and channels.

Conserve Natural Areas during Landscape Planning

If applicable, the following items are required and must be implemented in the site layout during the subdivision design and approval process, consistent with applicable General Plan and Local Area Plan policies:

- Cluster development on least-sensitive portions of a site while leaving the remaining land in a natural undisturbed condition.
- Limit clearing and grading of native vegetation at a site to the minimum amount needed to build lots, allow access, and provide fire protection.
- Maximize trees and other vegetation at each site by planting additional vegetation, clustering tree areas, and promoting the use of native and/or drought tolerant plants.
- Promote natural vegetation by using parking lot islands and other landscaped areas.
- Preserve riparian areas and wetlands.

Maximize Natural Water Storage and Infiltration Opportunities Within the Landscape Unit

- Promote the conservation of forest cover. Building on land that is already deforested affects basin hydrology to a lesser extent than converting forested land. Loss of forest cover reduces interception storage, detention in the organic forest floor layer, and water losses by evapotranspiration, resulting in large peak runoff increases and either their negative effects or the expense of countering them with structural solutions.
- Maintain natural storage reservoirs and drainage corridors, including depressions, areas of permeable soils, swales, and intermittent streams. Develop and implement policies and

Site Design & Landscape Planning SD-10

regulations to discourage the clearing, filling, and channelization of these features. Utilize them in drainage networks in preference to pipes, culverts, and engineered ditches.

- Evaluating infiltration opportunities by referring to the stormwater management manual for the jurisdiction and pay particular attention to the selection criteria for avoiding groundwater contamination, poor soils, and hydrogeological conditions that cause these facilities to fail. If necessary, locate developments with large amounts of impervious surfaces or a potential to produce relatively contaminated runoff away from groundwater recharge areas.

Protection of Slopes and Channels during Landscape Design

- Convey runoff safely from the tops of slopes.
- Avoid disturbing steep or unstable slopes.
- Avoid disturbing natural channels.
- Stabilize disturbed slopes as quickly as possible.
- Vegetate slopes with native or drought tolerant vegetation.
- Control and treat flows in landscaping and/or other controls prior to reaching existing natural drainage systems.
- Stabilize temporary and permanent channel crossings as quickly as possible, and ensure that increases in run-off velocity and frequency caused by the project do not erode the channel.
- Install energy dissipaters, such as riprap, at the outlets of new storm drains, culverts, conduits, or channels that enter unlined channels in accordance with applicable specifications to minimize erosion. Energy dissipaters shall be installed in such a way as to minimize impacts to receiving waters.
- Line on-site conveyance channels where appropriate, to reduce erosion caused by increased flow velocity due to increases in tributary impervious area. The first choice for linings should be grass or some other vegetative surface, since these materials not only reduce runoff velocities, but also provide water quality benefits from filtration and infiltration. If velocities in the channel are high enough to erode grass or other vegetative linings, riprap, concrete, soil cement, or geo-grid stabilization are other alternatives.
- Consider other design principles that are comparable and equally effective.

Redeveloping Existing Installations

Various jurisdictional stormwater management and mitigation plans (SUSMP, WQMP, etc.) define “redevelopment” in terms of amounts of additional impervious area, increases in gross floor area and/or exterior construction, and land disturbing activities with structural or impervious surfaces. The definition of “redevelopment” must be consulted to determine whether or not the requirements for new development apply to areas intended for redevelopment. If the definition applies, the steps outlined under “designing new installations” above should be followed.

SD-10 Site Design & Landscape Planning

Redevelopment may present significant opportunity to add features which had not previously been implemented. Examples include incorporation of depressions, areas of permeable soils, and swales in newly redeveloped areas. While some site constraints may exist due to the status of already existing infrastructure, opportunities should not be missed to maximize infiltration, slow runoff, reduce impervious areas, disconnect directly connected impervious areas.

Other Resources

A Manual for the Standard Urban Stormwater Mitigation Plan (SUSMP), Los Angeles County Department of Public Works, May 2002.

Stormwater Management Manual for Western Washington, Washington State Department of Ecology, August 2001.

Model Standard Urban Storm Water Mitigation Plan (SUSMP) for San Diego County, Port of San Diego, and Cities in San Diego County, February 14, 2002.

Model Water Quality Management Plan (WQMP) for County of Orange, Orange County Flood Control District, and the Incorporated Cities of Orange County, Draft February 2003.

Ventura Countywide Technical Guidance Manual for Stormwater Quality Control Measures, July 2002.



Rain Garden

Design Objectives

- Maximize Infiltration
- Provide Retention
- Slow Runoff
- Minimize Impervious Land Coverage
- Prohibit Dumping of Improper Materials
- Contain Pollutants
- Collect and Convey

Description

Various roof runoff controls are available to address stormwater that drains off rooftops. The objective is to reduce the total volume and rate of runoff from individual lots, and retain the pollutants on site that may be picked up from roofing materials and atmospheric deposition. Roof runoff controls consist of directing the roof runoff away from paved areas and mitigating flow to the storm drain system through one of several general approaches: cisterns or rain barrels; dry wells or infiltration trenches; pop-up emitters, and foundation planting. The first three approaches require the roof runoff to be contained in a gutter and downspout system. Foundation planting provides a vegetated strip under the drip line of the roof.

Approach

Design of individual lots for single-family homes as well as lots for higher density residential and commercial structures should consider site design provisions for containing and infiltrating roof runoff or directing roof runoff to vegetative swales or buffer areas. Retained water can be reused for watering gardens, lawns, and trees. Benefits to the environment include reduced demand for potable water used for irrigation, improved stormwater quality, increased groundwater recharge, decreased runoff volume and peak flows, and decreased flooding potential.

Suitable Applications

Appropriate applications include residential, commercial and industrial areas planned for development or redevelopment.

Design Considerations

Designing New Installations

Cisterns or Rain Barrels

One method of addressing roof runoff is to direct roof downspouts to cisterns or rain barrels. A cistern is an above ground storage vessel with either a manually operated valve or a permanently open outlet. Roof runoff is temporarily stored and then released for irrigation or infiltration between storms. The number of rain



barrels needed is a function of the rooftop area. Some low impact developers recommend that every house have at least 2 rain barrels, with a minimum storage capacity of 1000 liters. Roof barrels serve several purposes including mitigating the first flush from the roof which has a high volume, amount of contaminants, and thermal load. Several types of rain barrels are commercially available. Consideration must be given to selecting rain barrels that are vector proof and childproof. In addition, some barrels are designed with a bypass valve that filters out grit and other contaminants and routes overflow to a soak-away pit or rain garden.

If the cistern has an operable valve, the valve can be closed to store stormwater for irrigation or infiltration between storms. This system requires continual monitoring by the resident or grounds crews, but provides greater flexibility in water storage and metering. If a cistern is provided with an operable valve and water is stored inside for long periods, the cistern must be covered to prevent mosquitoes from breeding.

A cistern system with a permanently open outlet can also provide for metering stormwater runoff. If the cistern outlet is significantly smaller than the size of the downspout inlet (say $\frac{1}{4}$ to $\frac{1}{2}$ inch diameter), runoff will build up inside the cistern during storms, and will empty out slowly after peak intensities subside. This is a feasible way to mitigate the peak flow increases caused by rooftop impervious land coverage, especially for the frequent, small storms.

Dry wells and Infiltration Trenches

Roof downspouts can be directed to dry wells or infiltration trenches. A dry well is constructed by excavating a hole in the ground and filling it with an open graded aggregate, and allowing the water to fill the dry well and infiltrate after the storm event. An underground connection from the downspout conveys water into the dry well, allowing it to be stored in the voids. To minimize sedimentation from lateral soil movement, the sides and top of the stone storage matrix can be wrapped in a permeable filter fabric, though the bottom may remain open. A perforated observation pipe can be inserted vertically into the dry well to allow for inspection and maintenance.

In practice, dry wells receiving runoff from single roof downspouts have been successful over long periods because they contain very little sediment. They must be sized according to the amount of rooftop runoff received, but are typically 4 to 5 feet square, and 2 to 3 feet deep, with a minimum of 1-foot soil cover over the top (maximum depth of 10 feet).

To protect the foundation, dry wells must be set away from the building at least 10 feet. They must be installed in solids that accommodate infiltration. In poorly drained soils, dry wells have very limited feasibility.

Infiltration trenches function in a similar manner and would be particularly effective for larger roof areas. An infiltration trench is a long, narrow, rock-filled trench with no outlet that receives stormwater runoff. These are described under Treatment Controls.

Pop-up Drainage Emitter

Roof downspouts can be directed to an underground pipe that daylights some distance from the building foundation, releasing the roof runoff through a pop-up emitter. Similar to a pop-up irrigation head, the emitter only opens when there is flow from the roof. The emitter remains flush to the ground during dry periods, for ease of lawn or landscape maintenance.

Foundation Planting

Landscape planting can be provided around the base to allow increased opportunities for stormwater infiltration and protect the soil from erosion caused by concentrated sheet flow coming off the roof. Foundation plantings can reduce the physical impact of water on the soil and provide a subsurface matrix of roots that encourage infiltration. These plantings must be sturdy enough to tolerate the heavy runoff sheet flows, and periodic soil saturation.

Redeveloping Existing Installations

Various jurisdictional stormwater management and mitigation plans (SUSMP, WQMP, etc.) define “redevelopment” in terms of amounts of additional impervious area, increases in gross floor area and/or exterior construction, and land disturbing activities with structural or impervious surfaces. The definition of “redevelopment” must be consulted to determine whether or not the requirements for new development apply to areas intended for redevelopment. If the definition applies, the steps outlined under “designing new installations” above should be followed.

Supplemental Information

Examples

- City of Ottawa’s Water Links Surface –Water Quality Protection Program
- City of Toronto Downspout Disconnection Program
- City of Boston, MA, Rain Barrel Demonstration Program

Other Resources

Hager, Marty Catherine, Stormwater, “Low-Impact Development”, January/February 2003.
www.stormh2o.com

Low Impact Urban Design Tools, Low Impact Development Design Center, Beltsville, MD.
www.lid-stormwater.net

Start at the Source, Bay Area Stormwater Management Agencies Association, 1999 Edition



Design Objectives

- Maximize Infiltration
- Provide Retention
- Slow Runoff
- Minimize Impervious Land Coverage
- Prohibit Dumping of Improper Materials
- Contain Pollutants
- Collect and Convey

Description

Irrigation water provided to landscaped areas may result in excess irrigation water being conveyed into stormwater drainage systems.

Approach

Project plan designs for development and redevelopment should include application methods of irrigation water that minimize runoff of excess irrigation water into the stormwater conveyance system.

Suitable Applications

Appropriate applications include residential, commercial and industrial areas planned for development or redevelopment. (Detached residential single-family homes are typically excluded from this requirement.)

Design Considerations

Designing New Installations

The following methods to reduce excessive irrigation runoff should be considered, and incorporated and implemented where determined applicable and feasible by the Permittee:

- Employ rain-triggered shutoff devices to prevent irrigation after precipitation.
- Design irrigation systems to each landscape area's specific water requirements.
- Include design featuring flow reducers or shutoff valves triggered by a pressure drop to control water loss in the event of broken sprinkler heads or lines.
- Implement landscape plans consistent with County or City water conservation resolutions, which may include provision of water sensors, programmable irrigation times (for short cycles), etc.



- Design timing and application methods of irrigation water to minimize the runoff of excess irrigation water into the storm water drainage system.
- Group plants with similar water requirements in order to reduce excess irrigation runoff and promote surface filtration. Choose plants with low irrigation requirements (for example, native or drought tolerant species). Consider design features such as:
 - Using mulches (such as wood chips or bar) in planter areas without ground cover to minimize sediment in runoff
 - Installing appropriate plant materials for the location, in accordance with amount of sunlight and climate, and use native plant materials where possible and/or as recommended by the landscape architect
 - Leaving a vegetative barrier along the property boundary and interior watercourses, to act as a pollutant filter, where appropriate and feasible
 - Choosing plants that minimize or eliminate the use of fertilizer or pesticides to sustain growth
- Employ other comparable, equally effective methods to reduce irrigation water runoff.

Redeveloping Existing Installations

Various jurisdictional stormwater management and mitigation plans (SUSMP, WQMP, etc.) define “redevelopment” in terms of amounts of additional impervious area, increases in gross floor area and/or exterior construction, and land disturbing activities with structural or impervious surfaces. The definition of “redevelopment” must be consulted to determine whether or not the requirements for new development apply to areas intended for redevelopment. If the definition applies, the steps outlined under “designing new installations” above should be followed.

Other Resources

A Manual for the Standard Urban Stormwater Mitigation Plan (SUSMP), Los Angeles County Department of Public Works, May 2002.

Model Standard Urban Storm Water Mitigation Plan (SUSMP) for San Diego County, Port of San Diego, and Cities in San Diego County, February 14, 2002.

Model Water Quality Management Plan (WQMP) for County of Orange, Orange County Flood Control District, and the Incorporated Cities of Orange County, Draft February 2003.

Ventura Countywide Technical Guidance Manual for Stormwater Quality Control Measures, July 2002.



Design Objectives

- Maximize Infiltration
- Provide Retention
- Slow Runoff
- Minimize Impervious Land Coverage
- Prohibit Dumping of Improper Materials
- Contain Pollutants
- Collect and Convey

Description

Waste materials dumped into storm drain inlets can have severe impacts on receiving and ground waters. Posting notices regarding discharge prohibitions at storm drain inlets can prevent waste dumping. Storm drain signs and stencils are highly visible source controls that are typically placed directly adjacent to storm drain inlets.

Approach

The stencil or affixed sign contains a brief statement that prohibits dumping of improper materials into the urban runoff conveyance system. Storm drain messages have become a popular method of alerting the public about the effects of and the prohibitions against waste disposal.

Suitable Applications

Stencils and signs alert the public to the destination of pollutants discharged to the storm drain. Signs are appropriate in residential, commercial, and industrial areas, as well as any other area where contributions or dumping to storm drains is likely.

Design Considerations

Storm drain message markers or placards are recommended at all storm drain inlets within the boundary of a development project. The marker should be placed in clear sight facing toward anyone approaching the inlet from either side. All storm drain inlet locations should be identified on the development site map.

Designing New Installations

The following methods should be considered for inclusion in the project design and show on project plans:

- Provide stenciling or labeling of all storm drain inlets and catch basins, constructed or modified, within the project area with prohibitive language. Examples include “NO DUMPING



– DRAINS TO OCEAN” and/or other graphical icons to discourage illegal dumping.

- Post signs with prohibitive language and/or graphical icons, which prohibit illegal dumping at public access points along channels and creeks within the project area.

Note - Some local agencies have approved specific signage and/or storm drain message placards for use. Consult local agency stormwater staff to determine specific requirements for placard types and methods of application.

Redeveloping Existing Installations

Various jurisdictional stormwater management and mitigation plans (SUSMP, WQMP, etc.) define “redevelopment” in terms of amounts of additional impervious area, increases in gross floor area and/or exterior construction, and land disturbing activities with structural or impervious surfaces. If the project meets the definition of “redevelopment”, then the requirements stated under “designing new installations” above should be included in all project design plans.

Additional Information

Maintenance Considerations

- Legibility of markers and signs should be maintained. If required by the agency with jurisdiction over the project, the owner/operator or homeowner’s association should enter into a maintenance agreement with the agency or record a deed restriction upon the property title to maintain the legibility of placards or signs.

Placement

- Signage on top of curbs tends to weather and fade.
- Signage on face of curbs tends to be worn by contact with vehicle tires and sweeper brooms.

Supplemental Information

Examples

- Most MS4 programs have storm drain signage programs. Some MS4 programs will provide stencils, or arrange for volunteers to stencil storm drains as part of their outreach program.

Other Resources

A Manual for the Standard Urban Stormwater Mitigation Plan (SUSMP), Los Angeles County Department of Public Works, May 2002.

Model Standard Urban Storm Water Mitigation Plan (SUSMP) for San Diego County, Port of San Diego, and Cities in San Diego County, February 14, 2002.

Model Water Quality Management Plan (WQMP) for County of Orange, Orange County Flood Control District, and the Incorporated Cities of Orange County, Draft February 2003.

Ventura Countywide Technical Guidance Manual for Stormwater Quality Control Measures, July 2002.

Description

Trash storage areas are areas where a trash receptacle (s) are located for use as a repository for solid wastes. Stormwater runoff from areas where trash is stored or disposed of can be polluted. In addition, loose trash and debris can be easily transported by water or wind into nearby storm drain inlets, channels, and/or creeks. Waste handling operations that may be sources of stormwater pollution include dumpsters, litter control, and waste piles.

Approach

This fact sheet contains details on the specific measures required to prevent or reduce pollutants in stormwater runoff associated with trash storage and handling. Preventative measures including enclosures, containment structures, and impervious pavements to mitigate spills, should be used to reduce the likelihood of contamination.

Suitable Applications

Appropriate applications include residential, commercial and industrial areas planned for development or redevelopment. (Detached residential single-family homes are typically excluded from this requirement.)

Design Considerations

Design requirements for waste handling areas are governed by Building and Fire Codes, and by current local agency ordinances and zoning requirements. The design criteria described in this fact sheet are meant to enhance and be consistent with these code and ordinance requirements. Hazardous waste should be handled in accordance with legal requirements established in Title 22, California Code of Regulation.

Wastes from commercial and industrial sites are typically hauled by either public or commercial carriers that may have design or access requirements for waste storage areas. The design criteria in this fact sheet are recommendations and are not intended to be in conflict with requirements established by the waste hauler. The waste hauler should be contacted prior to the design of your site trash collection areas. Conflicts or issues should be discussed with the local agency.

Designing New Installations

Trash storage areas should be designed to consider the following structural or treatment control BMPs:

- Design trash container areas so that drainage from adjoining roofs and pavement is diverted around the area(s) to avoid run-on. This might include berming or grading the waste handling area to prevent run-on of stormwater.
- Make sure trash container areas are screened or walled to prevent off-site transport of trash.

Design Objectives

- Maximize Infiltration
- Provide Retention
- Slow Runoff
- Minimize Impervious Land Coverage
- Prohibit Dumping of Improper Materials
- Contain Pollutants
- Collect and Convey



- Use lined bins or dumpsters to reduce leaking of liquid waste.
- Provide roofs, awnings, or attached lids on all trash containers to minimize direct precipitation and prevent rainfall from entering containers.
- Pave trash storage areas with an impervious surface to mitigate spills.
- Do not locate storm drains in immediate vicinity of the trash storage area.
- Post signs on all dumpsters informing users that hazardous materials are not to be disposed of therein.

Redeveloping Existing Installations

Various jurisdictional stormwater management and mitigation plans (SUSMP, WQMP, etc.) define “redevelopment” in terms of amounts of additional impervious area, increases in gross floor area and/or exterior construction, and land disturbing activities with structural or impervious surfaces. The definition of “redevelopment” must be consulted to determine whether or not the requirements for new development apply to areas intended for redevelopment. If the definition applies, the steps outlined under “designing new installations” above should be followed.

Additional Information

Maintenance Considerations

The integrity of structural elements that are subject to damage (i.e., screens, covers, and signs) must be maintained by the owner/operator. Maintenance agreements between the local agency and the owner/operator may be required. Some agencies will require maintenance deed restrictions to be recorded of the property title. If required by the local agency, maintenance agreements or deed restrictions must be executed by the owner/operator before improvement plans are approved.

Other Resources

A Manual for the Standard Urban Stormwater Mitigation Plan (SUSMP), Los Angeles County Department of Public Works, May 2002.

Model Standard Urban Storm Water Mitigation Plan (SUSMP) for San Diego County, Port of San Diego, and Cities in San Diego County, February 14, 2002.

Model Water Quality Management Plan (WQMP) for County of Orange, Orange County Flood Control District, and the Incorporated Cities of Orange County, Draft February 2003.

Ventura Countywide Technical Guidance Manual for Stormwater Quality Control Measures, July 2002.

Treatment Control BMPs

General Description

Drain inserts are manufactured filters or fabric placed in a drop inlet to remove sediment and debris. There are a multitude of inserts of various shapes and configurations, typically falling into one of three different groups: socks, boxes, and trays. The sock consists of a fabric, usually constructed of polypropylene. The fabric may be attached to a frame or the grate of the inlet holds the sock. Socks are meant for vertical (drop) inlets. Boxes are constructed of plastic or wire mesh. Typically a polypropylene “bag” is placed in the wire mesh box. The bag takes the form of the box. Most box products are one box; that is, the setting area and filtration through media occur in the same box. Some products consist of one or more trays or mesh grates. The trays may hold different types of media. Filtration media vary by manufacturer. Types include polypropylene, porous polymer, treated cellulose, and activated carbon.

Inspection/Maintenance Considerations

Washout problems increase with rain intensity. Susceptibility of accumulated sediments to be re-suspended at low flow rates, can be corrected with an energy dissipater between gate and treatment areas.

Inspection Activities	Suggested Frequency
<ul style="list-style-type: none"> Inspect for sediment buildup and proper functioning. 	At the beginning of the wet season and after significant storms
<ul style="list-style-type: none"> Verify that stormwater enters the unit and does not leak around the perimeter. 	After construction.
Maintenance Activities	Suggested Frequency
<ul style="list-style-type: none"> Remove sediment as needed. 	At the beginning of the wet season and as necessary

Maintenance Concerns, Objectives, and Goals

- Sediment Removal

Targeted Constituents

- ✓ Sediment
- ✓ Nutrients
- ✓ Trash
- ✓ Metals
- ✓ Bacteria
- ✓ Oil and Grease
- ✓ Organics

Removal Effectiveness

See New Development and Redevelopment Handbook-Section 5.



DESIGN INFORMATION

- MATERIAL FINISH = ALUMINIZED TYPE 2
- PIPE GAUGE = 16GA.
- PERFORATED = NO
- DIAMETER = 96"
- LOADING = H20/H25
- SYS. INV.=

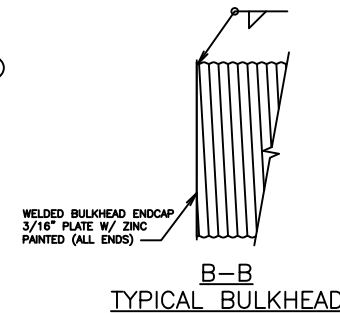
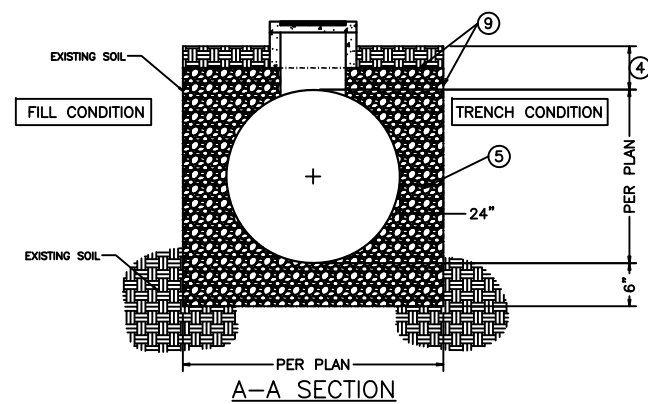
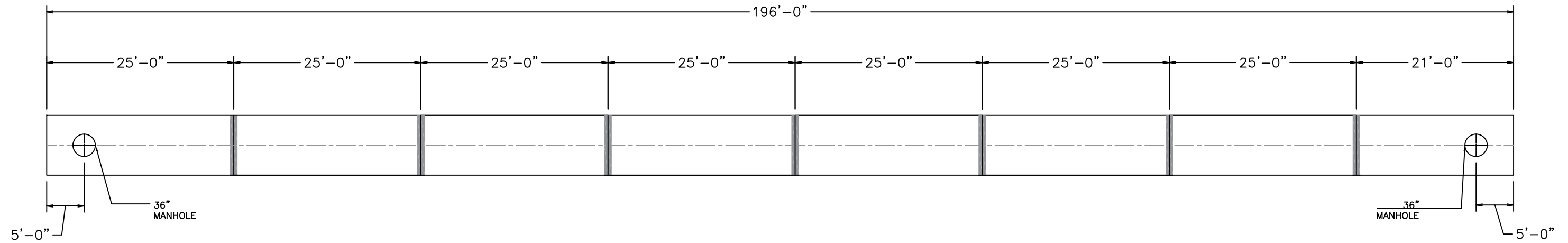

- NOTES:**
1. RIGID OR FLEXIBLE PAVEMENT.
 2. GRANULAR ROAD BASE.
 3. NORMAL ROADWAY EMBANKMENT FILL PLACED IN 8" LIFTS AND COMPACTED TO MIN. 90% STANDARD DENSITY PER AASHTO T-99.
 4. 12" MIN. FOR DIAMETERS THROUGH 96", 18" MIN. FOR DIAMETERS FROM 102" AND UP. MEASURE FROM TOP OF PIPE TO BOTTOM OF FLEXIBLE PAVEMENT OR TOP OF PIPE TO TOP OF RIGID PAVEMENT.
 5. FREE DRAINING ANGULAR WASHED STONE 3/4" - 2" AROUND PIPE ENVELOPE AS SHOWN OR OTHERWISE NOTED.
 6. 5 x 1" CSP GAGE PER AASHTO SECTION 12.
 7. NOT USED
 8. LISTED SPACING CHART IS FOR MULTIPLE PIPE INSTALLATION. FOR SINGLE RUN, THE TRENCH REQUIRES ONLY THE BOTTOM WIDTH OF THE PIPE'S SPAN, PLUS ROOM FOR COMPACTION EQUIPMENT.

SPACING CHART PER AISI AND NCSA GUIDELINES

DIAMETER	REQUIRED SPACING
UP TO 24"	12"
24" - 72"	1/2 PIPE DIA.
72" AND UP	36"

9. 4 oz. NON WOVEN GEOTEXTILE FABRIC.
10. RELATIVELY LOOSE GRANULAR BEDDING ROUGHLY SHAPED TO FIT BOTTOM OF PIPE, 4" TO 6" IN DEPTH. (#57 OR #8 OR OTHER SUITABLE GRANULAR).

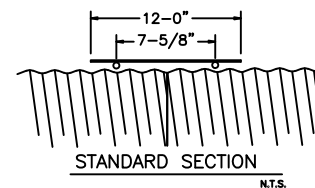
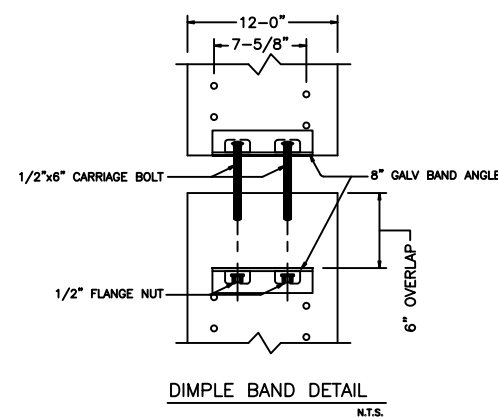
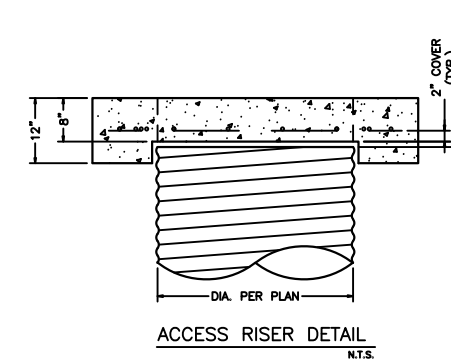
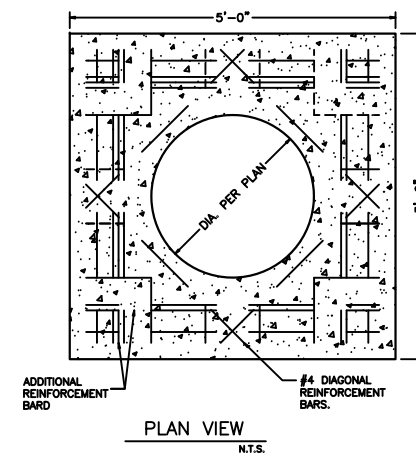

- GENERAL NOTES:**
1. BANDS ARE FURNISHED AS FOLLOWS:
12" THRU 48" - 1-PIECE
54" THRU 96" - 2-PIECE
102" THRU 144" - 3-PIECE
 2. GALV BAND ANGLES ARE ATTACHED WITH SPOT WELDS, RIVETS OR HAND WELDED.
 3. DIMENSIONS ARE SUBJECT TO MANUFACTURING TOLERANCES.
 4. DIMPLE BANDS FOR ARCHED PIPE ARE THE SAME AS FOR EQUIVALENT ROUND PIPE DIAMETER.

Table 7.8
General guidelines for minimum cover required for heavy off-road construction equipment

Pipe Span, in.	Minimum Cover (ft) for Indicted Axle Loads (kips)*			
	18-50	50-75	75-110	110-150
12-42	2.0	2.5	3.0	3.0
48-72	3.0	3.0	3.5	4.0
78-120	3.0	3.5	4.0	4.0
126-144	3.5	4.0	4.5	4.5

* Minimum cover may vary, depending on local conditions. The contractor must provide the additional cover required to avoid damage to the pipe. Minimum cover is measured from the top of the pipe to the top of the maintained construction roadway surface.

South Bay Foundry
www.southbayfoundry.com
PHONE (415) 961-8788 FAX (415) 961-8788

SBF 1251
36" MANHOLE FRAME AND COVER WITH STORAGE DRAIN

SET WEIGHT
FRAME 257 LB
COVER 344 LB
TOTAL 601 LB

GENERAL INFORMATION:
* MATERIAL CONFORMS TO ASTM A88 CLASS 300
* FINISHING SURFACE HAS 100% RUST PROTECTIVE COATING
* COATING SHALL BE OPTICALLY BLACK, TEMPOURANT PAINT
* FRAME AND COVER EXCEEDS 1400 WHEEL LOADING

APPROVED: _____
BY: _____
TITLE: _____
AGENCY: _____

HEAVY CONSTRUCTION
For temporary construction vehicle loads (100 kips/axle load), put at least four feet of compacted cover on top of the pipe (but not exceeding the maximum allowable cover over the pipe).

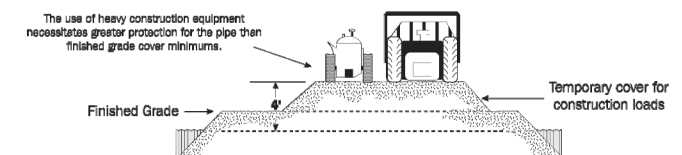

PACIFIC CORRUGATED PIPE CO.
13680 SLOVER AVENUE FONTANA, CA 92337
800.338.5858 * 909.829.4235
F: 909.829.8035
SOCAL@PCPIPE.COM

NOTE:
THE SUITABILITY OF THE INFORMATION PRESENTED FOR USE ON ANY PARTICULAR PROJECT SHOULD BE DETERMINED BY THE ENGINEER RESPONSIBLE FOR THE DESIGN.

PROJECT NAME:
1380 SOUTH E ST.

PROJECT #:

DRAWN BY:
C. CLARK

SCALE:
AS NOTED

DATE:
02-22-23

SHEET NO.:
1 OF 1

DATE TO RELEASE FOR MANUFACTURE (SUBJECT TO PRICE VERIFICATION)

PLANS APPROVED
 (AS NOTED) (W/CHANGES)

REV.	DATE	SIGNATURE	DESCRIPTION	DATE

Educational Materials

Stormwater Pollution Prevention

*Best Management Practices for Homeowner's Associations,
Property Managers and Property Owners*



*Your Guide To Maintaining Water
Friendly Standards In Your Community*

sbcountystormwater.org

Big Bear • Chino • Chino Hills • Colton • Fontana • Grand Terrace • Highland • Loma Linda • Montclair • Ontario • Rancho Cucamonga
Redlands • Rialto • San Bernardino • San Bernardino County • San Bernardino County Flood Control District • Upland • Yucaipa

» Table of Contents

Commercial Trash Enclosures	1
Hazardous Waste	2
Working Outdoors & Handling Spills	4
Commercial Landscape	5
Sidewalk, Plaza, Entry Monument & Fountain Maintenance	6
Equipment Maintenance & Repair	10
Pool Maintenance	14
Paint	16
Vehicle Maintenance	17
Pet Waste Disposal	18
Get In Touch With Us Online	19

COMMERCIAL TRASH ENCLOSURES

FOLLOW THESE REQUIREMENTS TO KEEP OUR WATERWAYS CLEAN

Trash enclosures, such as those found in commercial and apartment complexes, typically contain materials that are intended to find their way to a landfill or a recycling facility.

These materials are NOT meant to go into our local lakes and rivers.

PROTECT WATER QUALITY BY FOLLOWING THESE SIMPLE STEPS

PUT TRASH INSIDE

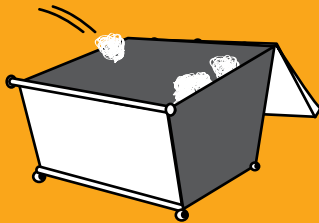

Place trash inside the bin (preferably in sealed bags)

CLOSE THE LID

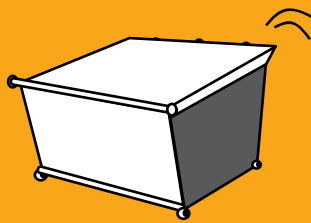

Prevent rain from entering the bin in order to avoid leakage of polluted water runoff

KEEP TOXICS OUT



- Paint
- Grease, fats and used oils
- Batteries, electronics and fluorescent lights

SOME ADDITIONAL GUIDELINES, INCLUDE

✓ SWEEP FREQUENTLY

Sweep trash enclosure areas frequently, instead of hosing them down, to prevent polluted water from flowing into the streets and storm drains.

✓ FIX LEAKS

Address trash bin leaks immediately by using dry clean up methods and report to your waste hauler to receive a replacement.

✓ CONSTRUCT ROOF

Construct a solid cover roof over the existing trash enclosure structure to prevent rainwater from coming into contact with trash and garbage. Check with your local City/County for Building Codes.

In San Bernardino County, stormwater pollution is caused by food waste, landscape waste, chemicals and other debris that are washed into storm drains and end up in our waterways - untreated! You can be part of the solution by maintaining a water-friendly trash enclosure.

THANK YOU FOR HELPING TO KEEP SAN BERNARDINO COUNTY CLEAN AND HEALTHY!



In the event of a spill or discharge to a storm drain or waterway, contact San Bernardino County Stormwater immediately: (877) WASTE18 | sbcountystormwater.org/report

sbcountystormwater.org

Big Bear • Chino • Chino Hills • Colton • Fontana • Grand Terrace • Highland • Loma Linda • Montclair • Ontario • Rancho Cucamonga • Redlands • Rialto • San Bernardino • San Bernardino County • San Bernardino County Flood Control District • Upland • Yucaipa

HAZARDOUS WASTE

CESQG PROGRAM

Conditionally Exempt Small Quantity Generator

WHAT IS A CESQG?

Businesses that generate 27 gallons or 220 lbs. of hazardous waste, or 2.2 lbs. of extremely hazardous waste per month are called "Conditionally Exempt Small Quantity Generators," or CESQGs. San Bernardino County Household Hazardous Program provides waste management services to CESQG businesses. The most common CESQGs in San Bernardino County are painters, print shops, auto shops, builders, agricultural operators and property managers, but there are many others. When you call, be ready to describe the types and amounts of waste your business generates in a typical month. If you generate hazardous waste on a regular basis, you must:

- Register with San Bernardino County Fire Department (909) 386-8401 as a hazardous waste generator.
- To obtain an EPA ID# and application form from the State visit www.dtsc.ca.gov.
- Manage hazardous waste in accordance with all applicable local, state and federal laws and regulations.

HOW DO I GET SERVICE?

To arrange an appointment for the CESQG Program, call 1-800-OILY CAT or 909-382-5401. Be ready to describe the type and amount of hazardous waste your business is ready to dispose of, and the types and size(s) of containers that the waste is in.

Waste Type and Cost

There is a small handling fee involved in the collection of hazardous waste from your business. Disposal costs depend on the type of waste.

Aerosols	\$1.29/lb.
Automobile motor oil	\$.73/gal.
Anti-freeze	\$1.57/gal.
Contaminated oil	\$4.48/gal.
Car batteries	\$.62/ea.
Corrosive liquids, solids	\$2.80/lb.
Flammable solids, liquids	\$1.57/lb.
Latex Paint	\$.73/lb.
Mercury	\$10.08/lb.
NiCad/Alkaline Batteries	\$2.13/lb.
Oil Base Paints	\$1.00/lb.
Oil Filters	\$.56/ea.
Oxidizers	\$9.63/lb.
PCB Ballasts	\$5.94/lb.
Pesticides (most)	\$2.91/lb.
Photofixer, developer	\$4.31/gal.
Television & Monitors	\$11.20/ea.
Additional Handling	\$138.00/hr.

Rates subject to change without notice

WE CANNOT ACCEPT

- * Radioactives
- * Water reactives
- * Explosives
- * Compressed gas cylinders
- * Medical or biohazardous waste
- * Asbestos
- * Remediation wastes



In the event of a spill or discharge to a storm drain or waterway, contact San Bernardino County Stormwater immediately: (877) WASTE18 | sbcountystormwater.org/report

sbcountystormwater.org

Big Bear • Chino • Chino Hills • Colton • Fontana • Grand Terrace • Highland • Loma Linda • Montclair • Ontario • Rancho Cucamonga • Redlands • Rialto • San Bernadino • San Bernadino County • San Bernadino County Flood Control District • Upland • Yucaipa

HAZARDOUS WASTE

WHY IS THE FIRE DEPARTMENT COLLECTING HAZARDOUS WASTE?

Small Quantity Generators often have difficulty disposing of small quantities of hazardous waste. Hazardous waste companies usually have a minimum amount of waste that they will pick up, or charge a minimum fee for service. Typically, the minimum fee exceeds the cost of disposal for the hazardous waste. This leaves the small quantity generator in a difficult situation. Some respond by storing hazardous waste until it becomes economical for the hazardous waste transporter to pick it up, putting the business out of compliance by exceeding regulatory accumulation time limits. Other businesses simply store their hazardous wastes indefinitely, creating an unsafe work environment and exceeding accumulation time limits. Yet other businesses attempt to illegally dispose of their waste at household hazardous waste collection facilities. These facilities are not legally permitted to accept commercial wastes, nor are prepared to provide legal documentation for commercial hazardous waste disposal. In answer to the problems identified above, the San Bernardino County Fire Department Household Hazardous Program instituted the Conditionally Exempt Small Quantity Generator Program.

PAYMENT FOR SERVICES

The CESQG Program will prepare an invoice for your business at the time of service. You can pay at the time of service with cash or a check, or you can mail your payment to the Fire Department within 30 days. Please note that we do not accept credit card payments. The preferred method of payment is to handle payment at time of service. Additional charges may apply for accounts not paid within 30 days.

ARE THERE ANY OTHER WAYS THAT I CAN SAVE MONEY ON HAZARDOUS WASTE DISPOSAL?

Yes! First, start by reducing the amount of waste that you produce by changing processes or process chemicals, at your business. Next, examine if there is a way that you can recycle your waste back into your processes. Network with similar businesses or trade associations for waste minimization and pollution prevention solutions.

WHAT IF YOUR BUSINESS DOES NOT QUALIFY?

Call the San Bernardino County Fire Department Field Services Division for assistance with hazardous waste management at 909-386-8401. If you reduce the amount of waste you generate each month to 27 gallons or less, you may qualify in the future.

WHAT HAPPENS TO YOUR HAZARDOUS WASTE?

Hazardous waste collected by the CESQG Program is transported to a state permitted processing facility in San Bernardino. The waste is further processed at this point and packaged for off-site recycling (oil filters, oil, latex paint, antifreeze, and batteries) or destructive incineration (pesticides, corrosives, flammables, oil based paint).

San Bernardino County Fire Department
CESQG Program
2824 East "W" Street
San Bernardino, CA 92415-0799
Phone: 909-382-5401
Fax: 909-382-5413
www.sbcfire.org/hazmat/hhw.asp
Email: jschwab@sbcfire.org



In the event of a spill or discharge to a storm drain or waterway, contact San Bernardino County Stormwater immediately: (877) WASTE18 | sbcountystormwater.org/report

sbcountystormwater.org

Big Bear • Chino • Chino Hills • Colton • Fontana • Grand Terrace • Highland • Loma Linda • Montclair • Ontario • Rancho Cucamonga • Redlands • Rialto • San Bernardino • San Bernardino County • San Bernardino County Flood Control District • Upland • Yucaipa

WHEN WORKING OUTDOORS USE THE 3Cs

CUANDO TRABAJE AL AIRE LIBRE UTILICE LAS 3Cs

CONTROL | CONTROL



Locate the nearest storm drain and ensure nothing can enter or be discharged into it.

Ubique el desagüe de aguas pluviales más cercano y asegúrese de que nada pueda ingresar a éste ni descargarse en él.

CONTAIN | CONTENER



Isolate your area to prevent material from potentially flowing or being blown away.

Aísle su área para evitar que el material pueda discurrirse o ser llevado por el viento.

CAPTURE | CAPTURAR



Sweep up debris and place it in the trash. Clean up spills with an absorbent material (e.g. kitty litter) or vacuum with a Wet-Vac and dispose of properly.

Recoja los restos y colóquelos en la basura. Limpie los derrames con un material absorbente (como la arena para gatos) o aspírelos con una Wet-Vac (aspiradora de humedad) y deséchelos correctamente.



In the event of a spill or discharge to a storm drain or waterway, contact San Bernadino County Stormwater immediately: (877) WASTE18 | sbcountystormwater.org/report

sbcountystormwater.org

Big Bear • Chino • Chino Hills • Colton • Fontana • Grand Terrace • Highland • Loma Linda • Montclair • Ontario • Rancho Cucamonga • Redlands • Rialto • San Bernadino • San Bernadino County • San Bernadino County Flood Control District • Upland • Yucaipa

COMMERCIAL LANDSCAPE

DISCHARGE TO THE STORM DRAIN, ACCIDENTAL OR NOT, COULD LEAD TO ENFORCEMENT ACTIONS, WHICH COULD INCLUDE FINES.

Follow the best practices below to **prevent water pollution from landscaping activities.**

RECYCLE YARD WASTE



- ✓ Recycle leaves, grass clippings and other yard waste.
- ✓ Do not blow, sweep, rake or hose yard waste into the street or catch basin.
- ✓ **Try grasscycling:** the natural recycling of grass by leaving clippings on the lawn when mowing.

For more information, please visit:
www.calrecycle.ca.gov/organics/grasscycling

USE FERTILIZERS, HERBICIDES AND PESTICIDES SAFELY



- ✓ Fertilizers, herbicides and pesticides are often carried into the storm drain system by sprinkler runoff. Use natural and non-toxic alternatives as often as possible.
- ✓ If you must use chemical fertilizers, herbicides or pesticides:
 - Spot apply, rather than blanketing entire areas.
 - Avoid applying near curbs and driveways, and **never** before a rain.
 - Apply fertilizers as needed: when plants could best use it and when the potential runoff would be low.
 - Follow the manufacturer's instructions carefully—this will not only give the best results, but will save money.

USE WATER WISELY



- ✓ Control the amount of water and direction of sprinklers. Sprinklers should only be on long enough to allow water to soak into the ground, but not so long as to cause runoff.
- ✓ Periodically inspect, fix leaks and realign sprinkler heads.
- ✓ Plant native vegetation to reduce the need of water, fertilizers, herbicides and pesticides.

! HOMEOWNERS

KEEP THESE TIPS IN MIND WHEN HIRING PROFESSIONAL LANDSCAPERS AND REMIND AS NECESSARY.



Leftover pesticides, fertilizers, and herbicides contaminate landfills and should be disposed of through a Hazardous Waste Facility.

For more information on proper disposal call,

(909) 382-5401 or 1-800-OILY CAT.

*FREE for San Bernardino County residents only. Businesses can call for cost inquiries and to schedule an appointment.



In the event of a spill or discharge to a storm drain or waterway, contact San Bernardino County Stormwater immediately: (877) WASTE18 | sbcountystormwater.org/report

sbcountystormwater.org

Big Bear • Chino • Chino Hills • Colton • Fontana • Grand Terrace • Highland • Loma Linda • Montclair • Ontario • Rancho Cucamonga • Redlands • Rialto • San Bernadino • San Bernadino County • San Bernadino County Flood Control District • Upland • Yucaipa

SIDEWALK, PLAZA, ENTRY MONUMENT & FOUNTAIN MAINTENANCE

Pollutants on sidewalks and other pedestrian traffic areas and plazas are typically due to littering and vehicle use. Fountain water containing chlorine and copperbased algaecides is toxic to aquatic life. Proper inspection, cleaning, and repair of pedestrian areas and HOA owned surfaces and structures can reduce pollutant runoff from these areas. Maintaining these areas may involve one or more of the following activities:

- 1. Surface Cleaning**
- 2. Graffiti Cleaning**
- 3. Sidewalk Repair**
- 4. Controlling Litter**
- 5. Fountain Maintenance**

POLLUTION PREVENTION:

Pollution prevention measures have been considered and incorporated in the model procedures. Implementation of these measures may be more effective and reduce or eliminate the need to implement other more complicated or costly procedures. Possible pollution prevention measures for sidewalk, plaza, and fountain maintenance and cleaning include:

- Use dry cleaning methods whenever practical for surface cleaning activities.
- Use the least toxic materials available (e.g. water based paints, gels or sprays for graffiti removal).
- Once per year, educate HOA staff and tenants on pollution prevention measures.

MODEL PROCEDURES:

1. Surface Cleaning

Discharges of wash water to the storm water drainage system from cleaning or hosing of impervious surfaces is prohibited.

Sidewalks, Plazas

- ✓ Use dry methods (e.g. sweeping, backpack blowers, vacuuming) whenever practical to clean sidewalks and plazas rather than hosing, pressure washing, or steam cleaning. **DO NOT** sweep or blow material into curb; use devices that contain the materials.
- ✓ If water must be used, block storm drain inlets and contain runoff. Discharge wash water to landscaping or contain and dispose of properly.



In the event of a spill or discharge to a storm drain or waterway, contact San Bernardino County Stormwater immediately: (877) WASTE18 | sbcountystormwater.org/report

sbcountystormwater.org

Big Bear • Chino • Chino Hills • Colton • Fontana • Grand Terrace • Highland • Loma Linda • Montclair • Ontario • Rancho Cucamonga • Redlands • Rialto • San Bernardino • San Bernardino County • San Bernardino County Flood Control District • Upland • Yucaipa

SIDEWALK, PLAZA, ENTRY MONUMENT & FOUNTAIN MAINTENANCE

Parking Areas, Driveways, Drive-thru

- ✓ Parking facilities should be swept/vacuumed on a regular basis. Establish frequency of public parking lot sweeping based on usage and field observations of waste accumulation.
- ✓ If water must be used, block storm drain inlets and contain runoff. Discharge wash water to landscaping or contain and dispose of properly.
- ✓ Sweep all parking lots at least once before the onset of the wet season.
- ✓ Use absorbents to pick up oil; then dry sweep.
- ✓ Appropriately dispose of spilled materials and absorbents.

OPTIONAL:

- Consider increasing sweeping frequency based on factors such as traffic volume, land use, field observations of sediment and trash accumulation, proximity to water courses, etc.

Building Surfaces, Decks, etc., without loose paint

- ✓ Use high-pressure water, no soap.
- ✓ If water must be used, block storm drain inlets and contain runoff. Discharge wash water to landscaping or contain and dispose of properly.

Unpainted Building Surfaces, Wood Decks, etc.

- ✓ If water must be used, block storm drain inlets and contain runoff. Discharge wash water to landscaping or contain and dispose of properly.
- ✓ Use biodegradable cleaning agents to remove deposits.
- ✓ Make sure pH is between 6.5 and 8.5 THEN discharge to landscaping (if cold water without a cleaning agent) otherwise dispose of properly.

2. Graffiti Cleaning

Graffiti Removal

- ✓ Avoid graffiti abatement activities during rain events.
- ✓ When graffiti is removed by painting over, implement the procedures under Painting and Paint Removal in the Roads, Streets, and Highway Operation and Maintenance procedure sheet.
- ✓ Protect nearby storm drain inlets prior to removing graffiti from walls, signs, sidewalks, or other structures needing graffiti abatement. Clean up afterwards by sweeping or vacuuming thoroughly, and/or by using absorbent and properly disposing of the absorbent.



In the event of a spill or discharge to a storm drain or waterway, contact San Bernardino County Stormwater immediately: (877) WASTE18 | sbcountystormwater.org/report

sbcountystormwater.org

Big Bear • Chino • Chino Hills • Colton • Fontana • Grand Terrace • Highland • Loma Linda • Montclair • Ontario • Rancho Cucamonga • Redlands • Rialto • San Bernardino • San Bernardino County • San Bernardino County Flood Control District • Upland • Yucaipa

SIDEWALK, PLAZA, ENTRY MONUMENT & FOUNTAIN MAINTENANCE

- ✓ Note that care should be taken when disposing of waste since it may need to be disposed of as hazardous waste.

OPTIONAL:

- Consider using a waterless and non-toxic chemical cleaning method for graffiti removal (e.g. gels or spray compounds).

3. Sidewalk Repair

Surface Removal and Repair

- ✓ Schedule surface removal activities for dry weather if possible.
- ✓ Avoid creating excess dust when breaking asphalt or concrete.
- ✓ Take measures to protect nearby storm drain inlets prior to breaking up asphalt or concrete (e.g. place hay bales or sand bags around inlets). Clean afterwards by sweeping up material.
- ✓ Designate an area for clean up and proper disposal of excess materials.
- ✓ Remove and recycle as much of the broken pavement as possible.
- ✓ When making saw cuts in pavement, use as little water as possible. Cover each storm drain inlet with filter fabric during the sawing operation and contain the slurry by placing straw bales, sandbags, or gravel dams around the inlets. After the liquid drains shovel or vacuum the slurry, remove from site and dispose of properly.
- ✓ Always dry sweep first to clean up tracked dirt. Use a street sweeper or vacuum truck. Do not dump vacuumed liquid in storm drains. Once dry sweeping is complete, the area may be hosed down if needed. Discharge wash water to landscaping, pump to the sanitary sewer if permitted to do so or contain and dispose of properly.

Concrete Installation and Repair

- ✓ Avoid mixing excess amounts of fresh concrete or cement mortar on-site. Only mix what is needed for the job.
- ✓ Wash concrete trucks off-site or in designated areas on-site, such that there is no discharge of concrete wash water into storm drain inlets, open ditches, streets, or other storm water conveyance structures. (See Concrete Waste Management BMP WM – 8)



In the event of a spill or discharge to a storm drain or waterway, contact San Bernardino County Stormwater immediately: (877) WASTE18 | sbcountystormwater.org/report

sbcountystormwater.org

Big Bear • Chino • Chino Hills • Colton • Fontana • Grand Terrace • Highland • Loma Linda • Montclair • Ontario • Rancho Cucamonga • Redlands • Rialto • San Bernadino • San Bernadino County • San Bernadino County Flood Control District • Upland • Yucaipa

SIDEWALK, PLAZA, ENTRY MONUMENT & FOUNTAIN MAINTENANCE

- ✓ Store dry and wet concrete materials under cover, protected from rainfall and runoff and away from drainage areas. After job is complete remove temporary stockpiles (asphalt materials, sand, etc.) and other materials as soon as possible.
- ✓ Return leftover materials to the transit mixer. Dispose of small amounts of excess concrete, grout, and mortar in the trash.
- ✓ When washing concrete to remove fine particles and expose the aggregate, contain the wash water for proper disposal.
- ✓ Do not wash sweepings from exposed aggregate concrete into the street or storm drain. Collect and return sweepings to aggregate base stock pile, or dispose in the trash.
- ✓ Protect applications of fresh concrete from rainfall and runoff until the material has hardened.

4. Litter Control

- ✓ Enforce anti-litter laws.
- ✓ Provide litter receptacles in busy, high pedestrian traffic areas of the community, at recreational facilities, and at community events.
- ✓ Cover litter receptacles and clean out frequently to prevent leaking/spillage or overflow.

OPTIONAL:

- Post "No Littering" signs.

5. Fountain Maintenance

- ✓ Do not use copper-based algaecides. Control algae with chlorine or other alternatives, such as sodium bromide.
- ✓ Allow chlorine to dissipate for a few days and then recycle/reuse water by draining it gradually onto a landscaped area. Water must be tested prior to discharge to ensure that chlorine is not present (concentration must be less than 0.1 ppm).
- ✓ Contact local agency for approval to drain into sewer or storm drain.
- ✓ Avoid mixing excess amounts of fresh concrete or cement mortar on-site. Only mix what is needed for the job.



In the event of a spill or discharge to a storm drain or waterway, contact San Bernardino County Stormwater immediately: (877) WASTE18 | sbcountystormwater.org/report

sbcountystormwater.org

Big Bear • Chino • Chino Hills • Colton • Fontana • Grand Terrace • Highland • Loma Linda • Montclair • Ontario • Rancho Cucamonga • Redlands • Rialto • San Bernardino • San Bernardino County • San Bernardino County Flood Control District • Upland • Yucaipa

EQUIPMENT MAINTENANCE & REPAIR

Vehicle or equipment maintenance has the potential to be a significant source of stormwater pollution. Engine repair and service (parts cleaning, spilled fuel, oil, etc.), replacement of fluids, and outdoor equipment storage and parking (dripping engines) can all contaminate stormwater. Conducting the following activities in a controlled manner will reduce the potential for stormwater contamination:

- 1. General Maintenance and Repair**
- 2. Vehicle and Machine Repair**
- 3. Waste Handling/Disposal**

Related vehicle maintenance activities are covered under the following program headings in this manual: “Vehicle and Equipment Cleaning”, “Vehicle and Equipment Storage”, and “Vehicle Fueling”.

POLLUTION PREVENTION:

Pollution prevention measures have been considered and incorporated in the model procedures. Implementation of these measures may be more effective and reduce or eliminate the need to implement other more complicated or costly procedures. Possible pollution prevention measures for equipment maintenance and repair include:

- Review maintenance activities to verify that they minimize the amount of pollutants discharged to receiving waters. Keep accurate maintenance logs to evaluate materials removed and improvements made.
- Switch to non-toxic chemicals for maintenance when possible.
- Choose cleaning agents that can be recycled.
- Minimize use of solvents. Clean parts without using solvents whenever possible. Recycle used motor oil, diesel oil, and other vehicle fluids and parts whenever possible.
- Once per year, educate HOA staff and tenants on pollution prevention measures.



In the event of a spill or discharge to a storm drain or waterway, contact San Bernardino County Stormwater immediately: (877) WASTE18 | sbcountystormwater.org/report

sbcountystormwater.org

Big Bear • Chino • Chino Hills • Colton • Fontana • Grand Terrace • Highland • Loma Linda • Montclair • Ontario • Rancho Cucamonga • Redlands • Rialto • San Bernadino • San Bernadino County • San Bernadino County Flood Control District • Upland • Yucaipa

EQUIPMENT MAINTENANCE & REPAIR

MODEL PROCEDURES:

1. General Maintenance and Repair

General Guidelines

→ *Note: Permission must be obtained for any discharge of wash water to the sanitary sewer from the local sewerage agency.*

- ✓ Review maintenance activities to verify that they minimize the amount of pollutants discharged to receiving waters. Keep accurate maintenance logs to evaluate materials removed and improvements made.
- ✓ Regularly inspect vehicles and equipment for leaks.
- ✓ Move activity indoors or cover repair area with a permanent roof if feasible.
- ✓ Minimize contact of stormwater with outside operations through berming the local sewerage and drainage routing.
- ✓ Place curbs around the immediate boundaries of the process equipment.
- ✓ Clean yard storm drain inlets regularly and stencil them.

Good Housekeeping

- ✓ Avoid hosing down work areas. If work areas are washed and if discharge to the sanitary sewer is allowed, treat water with an appropriate treatment device (e.g. clarifier) before discharging. If discharge to the sanitary sewer is not permitted, pump water to a tank and dispose of properly.
- ✓ Collect leaking or dripping fluids in drip pans or container. Fluids are easier to recycle or dispose of properly if kept separate.
- ✓ Keep a drip pan under the vehicle while you unclip hoses, unscrew filters, any discharge of or remove other parts. Place a drip pan under any vehicle that might leak while you work on it to keep splatters or drips off the shop floor.
- ✓ Educate employees on proper handling and disposal of engine fluids.
- ✓ Promptly transfer used fluids to the proper waste or recycling drums. Don't leave full drip pans or other open containers lying around.
- ✓ Do not pour liquid waste to floor drains, sinks, outdoor storm drain inlets, or other storm drains or sewer connections.
- ✓ Post signs at sinks and stencil outdoor storm drain inlets.

2. Vehicle Repair

General Guidelines

- ✓ Perform vehicle fluid removal or changing inside of a building or in a contained covered area, where feasible, to prevent the run-on of stormwater and the runoff of spills.
- ✓ Regularly inspect vehicles and equipment for leaks, and repair as needed.



In the event of a spill or discharge to a storm drain or waterway, contact San Bernardino County Stormwater immediately: (877) WASTE18 | sbcountystormwater.org/report

sbcountystormwater.org

Big Bear • Chino • Chino Hills • Colton • Fontana • Grand Terrace • Highland • Loma Linda • Montclair • Ontario • Rancho Cucamonga • Redlands • Rialto • San Bernardino • San Bernardino County • San Bernardino County Flood Control District • Upland • Yucaipa

EQUIPMENT MAINTENANCE & REPAIR

- ✓ Use secondary containment, such as a drain pan or drop cloth, to catch spills or leaks when removing or changing fluids.
- ✓ Immediately drain all fluids from wrecked vehicles. Ensure that the drain pan or drip pan is large enough to contain drained fluids (e.g. larger pans are needed to contain antifreeze, which may gush from some vehicles).
- ✓ Promptly transfer used fluids to the proper waste or recycling drums. Don't leave full drip pans or other open containers lying around.
- ✓ Recycle used motor oil, diesel oil, and other vehicle fluids and parts whenever possible.
- ✓ Oil filters disposed of in trash cans or dumpsters can leak oil. Place the oil filter in a funnel over a waste oil recycling drum to drain excess oil before disposal. Oil filters can also be recycled. Ask your oil supplier or recycler about recycling oil filters.
- ✓ Store cracked batteries in a non-leaking secondary container and dispose of properly at recycling facilities or at County hazardous waste disposal site.

Vehicle Leak and Spill Control

- ✓ Use absorbent materials on small spills. Remove the absorbent materials promptly and dispose of properly.
- ✓ Place a stockpile of spill cleanup materials where it will be readily accessible.
- ✓ Sweep floor using dry absorbent material.

3. Machine Repair

- ✓ Keep equipment clean; don't allow excessive build-up of oil or grease.
- ✓ Minimize use of solvents.
- ✓ Use secondary containment, such as a drain pan or drop cloth, to catch spills or leaks when removing or changing fluids.
- ✓ Perform major equipment repairs at the corporation yard, when practical.
- ✓ Following good housekeeping measures in Vehicle Repair section.

4. Waste Handling/Disposal

Waste Reduction

- ✓ Prevent spills and drips of solvents and cleansers to the shop floor.
- ✓ Do liquid cleaning at a centralized station so the solvents and residues stay in one area. Recycle liquid cleaners when feasible.



In the event of a spill or discharge to a storm drain or waterway, contact San Bernardino County Stormwater immediately: (877) WASTE18 | sbcountystormwater.org/report

sbcountystormwater.org

Big Bear • Chino • Chino Hills • Colton • Fontana • Grand Terrace • Highland • Loma Linda • Montclair • Ontario • Rancho Cucamonga • Redlands • Rialto • San Bernardino • San Bernardino County • San Bernardino County Flood Control District • Upland • Yucaipa

EQUIPMENT MAINTENANCE & REPAIR

- ✓ Locate drip pans, drain boards, and drying racks to direct drips back into a solvent sink or fluid holding tank for reuse.

OPTIONAL:

- If possible, eliminate or reduce the amount of hazardous materials and waste by substituting non-hazardous or less hazardous material:
 - Use non-caustic detergents instead of caustic cleaning for parts cleaning.
 - Use a water-based cleaning service and have tank cleaned. Use detergent-based or water-based cleaning systems in place of organic solvent degreasers.
 - Replace chlorinated organic solvents with non-chlorinated solvents. Non-chlorinated solvents like kerosene or mineral spirits are less toxic and less expensive to dispose of properly. Check list of active ingredients to see whether it contains chlorinated solvents.
 - Choose cleaning agents that can be recycled.

Recycling

OPTIONAL:

- Separate wastes for easier recycling. Keep hazardous and non-hazardous wastes separate, do not mix used oil and solvents, and keep chlorinated solvents separate from non-chlorinated solvents.
- Label and track the recycling of waste material (e.g. used oil, spent solvents, batteries).
- Purchase recycled products to support the market for recycled materials.

LIMITATIONS:

Space and time limitations may preclude all work being conducted indoors. It may not be possible to contain and clean up spills from vehicles/equipment brought on-site after working hours. Dry floor cleaning methods may not be sufficient for some spills – see spill prevention and control procedures sheet. Identification of engine leaks may require some use of solvents.



In the event of a spill or discharge to a storm drain or waterway, contact San Bernardino County Stormwater immediately: (877) WASTE18 | sbcountystormwater.org/report

sbcountystormwater.org

Big Bear • Chino • Chino Hills • Colton • Fontana • Grand Terrace • Highland • Loma Linda • Montclair • Ontario • Rancho Cucamonga • Redlands • Rialto • San Bernadino • San Bernadino County • San Bernadino County Flood Control District • Upland • Yucaipa

POOL MAINTENANCE

Pool chemicals and filter solids, when discharged to the City streets, gutters or storm drains, DO NOT GET TREATED before reaching the Santa Ana River. Chlorine, acid cleaning chemicals and metal-based algaecides used in pools can kill beneficial organisms in the food chain and pollute our drinking water.

When emptying your swimming pool, spa or fountain, please use one of the following best management practices to prevent water pollution:

- Reuse the water as landscape irrigation
- Empty the water into the sewer between midnight and 6:00 am
- Remove solids and floating debris and dispose of in the trash, de-chlorinate the water to a chlorine residual = 0, wait 24 hours, then discharge the water to the street or storm drain
- Try not to use metal-based algaecides (i.e. copper sulfate) in your pool or spa. If you have, empty your pool or spa into the sewer. *Prior to discharging pool water into the sanitary sewer system, contact your local agency.*
- If the pool contains algae and mosquito larvae, discharge the water to the sewer

When acid cleaning or other chemical cleaning:

- Neutralize the pool water to pH of 6.5 to 8.5, then discharge to the sewer

For swimming pool and spa filter backwash:

- Dispose of solids into trash bag, then wash filter into a landscape area
- Settle, dispose of solids in trash and discharge water to the sewer, never to the storm drain



In the event of a spill or discharge to a storm drain or waterway, contact San Bernardino County Stormwater immediately: (877) WASTE18 | sbcountystormwater.org/report

sbcountystormwater.org

Big Bear • Chino • Chino Hills • Colton • Fontana • Grand Terrace • Highland • Loma Linda • Montclair • Ontario • Rancho Cucamonga • Redlands • Rialto • San Bernardino • San Bernardino County • San Bernardino County Flood Control District • Upland • Yucaipa

» For Residents

The following is a preview of the information we have available to residents. For more fact sheets, visit sbcountystormwater.org

Household Hazardous Waste Center Locations

TOO TOXIC TO TRASH

Dispose of your **HOUSEHOLD HAZARDOUS WASTE (HHW)** at a **FREE** HHW Center near you. Examples of items collected: pesticides, fertilizers, paints, cleaners, antifreeze, batteries, motor oil, oil filters, and electronic waste.

SERVICE AREA	LOCATION	DAYS OPEN	HOURS
Big Bear Lake <small>(does not accept E-waste)</small>	42040 Garstin Dr. (cross: Big Bear Blvd.)	Saturdays	9 a.m. - 2 p.m.
Chino	5050 Schaefer Ave. (cross: 4th St.)	2 nd & 4 th Sat.	8 a.m. - 1 p.m.
Fontana <small>(Fontana residents only)</small>	16454 Orange Way (cross: Cypress Ave.) <small>Note: Provide a trash bill and a driver's license as proof of residency.</small>	Saturdays	8 a.m. - 12 p.m.
Ontario	1430 S. Cucamonga Ave. (cross: Belmont St.)	Fri. & Sat.	9 a.m. - 2 p.m.
Rancho Cucamonga	8794 Lion Street. (Off 9th St, between Vineyard and Hellman)	Saturdays	8 a.m. - 12 p.m.
Redlands	500 Kansas St. (cross: Park Ave.)	Saturdays	9:30 a.m. - 12:30 p.m.
Rialto <small>(does not accept E-waste)</small>	246 Willow Ave. (cross: Rialto Ave.)	2 nd & 4 th Fri. & Sat.	8 a.m. - 12 p.m.
San Bernardino	2824 East 'W' St., 302 (cross: Victoria Ave.)	Mon. - Fri.	9 a.m. - 4 p.m.
Upland	1370 N. Benson Ave. (cross: 14th St.)	Saturdays	9 a.m. - 2 p.m.



To report illegal dumping, call **(877) WASTE18**
or visit sbcountystormwater.org

Artwork Courtesy of the City of Los Angeles Stormwater Program. Printed on recycled paper.

TAKE ONE



WE DID IT OURSELVES AND WE DID IT RIGHT



When painting your home,
protect your family and community.

- **PAINTS** that are water-based are less toxic and should be used whenever possible.
- **BRUSHES** with water-based paint should be washed in the sink. Those with oil-based paint should be cleaned with paint thinner.
- **SAFELY** dispose of unwanted paint and paint thinner. The County of San Bernardino offers 9 HHW Centers that accept paint and other household hazardous waste from residents **FREE** of charge. For a list of acceptable materials, location information, and hours of operation call 1-800-OILY CAT.



In the event of a spill or discharge to a storm drain or waterway, contact San Bernardino County Stormwater immediately: (877) WASTE18 | sbcountystormwater.org/report

sbcountystormwater.org

Big Bear • Chino • Chino Hills • Colton • Fontana • Grand Terrace • Highland • Loma Linda • Montclair • Ontario • Rancho Cucamonga
Redlands • Rialto • San Bernardino • San Bernardino County • San Bernardino County Flood Control District • Upland • Yucaipa

VEHICLE MAINTENANCE

Oil, grease, anti-freeze and other toxic automotive fluids often make their way into the San Bernardino County storm drain system, and do not get treated before reaching the Santa Ana River. This pollutes our drinking water and contaminates waterways, making them unsafe for people and wildlife. Follow these best management practices to prevent pollution and protect public health.

Cleaning Auto Parts

Scrape parts with a wire brush or use a bake oven rather than liquid cleaners. Arrange drip pans, drying racks and drain boards so that fluids are directed back into the parts washer or the fluid holding tank. Do not wash parts or equipment in a sink, parking lot, driveway or street.

Storing Hazardous Waste

Keep your liquid waste segregated. Many fluids can be recycled via hazardous waste disposal companies if they are not mixed. Store all materials under cover with spill containment or inside to prevent contamination of rainwater runoff.

Preventing Leaks and Spills

Conduct all vehicle maintenance inside of a garage. Place drip pans underneath vehicle to capture fluids. Use absorbent materials instead of water to clean work areas.

Cleaning Spills

Use dry methods for spill cleanup (sweeping, absorbent materials). To report accidental spills into the street or storm drain call (877) WASTE18 or 911.

Proper Disposal of Hazardous Waste

Dispose of household hazardous waste by taking it to your nearest household hazardous waste center. For more information, call 1-800-OILY CAT or check out sbcountystormwater.org/Disposal.html



In the event of a spill or discharge to a storm drain or waterway, contact San Bernardino County Stormwater immediately: (877) WASTE18 | sbcountystormwater.org/report

sbcountystormwater.org

Big Bear • Chino • Chino Hills • Colton • Fontana • Grand Terrace • Highland • Loma Linda • Montclair • Ontario • Rancho Cucamonga • Redlands • Rialto • San Bernadino • San Bernadino County • San Bernadino County Flood Control District • Upland • Yucaipa

PET WASTE DISPOSAL

FREE DOGGIE WASTE BAGS

Remember to pick up after your pet **every time** to keep San Bernardino County clean and healthy!

To **RECEIVE** your
FREE CONTAINER
visit us online at
sbcountystormwater.org/dog



In the event of a spill or discharge to a storm drain or waterway, contact San Bernardino County Stormwater immediately: (877) WASTE18 | sbcountystormwater.org/report

sbcountystormwater.org

Big Bear • Chino • Chino Hills • Colton • Fontana • Grand Terrace • Highland • Loma Linda • Montclair • Ontario • Rancho Cucamonga • Redlands • Rialto • San Bernadino • San Bernadino County • San Bernadino County Flood Control District • Upland • Yucaipa

» Get In Touch With Us Online!



» **Website**
sbcountystormwater.org



» **eUpdates**
sbcountystormwater.org/newsletter



» **Facebook**
facebook.com/sbcountystormwater



» **YouTube**
youtube.com/sbcountystormwater



» **Report Pollution Violations**
sbcountystormwater.org/report



» **Email**
info@sbcountystormwater.org



SAN BERNARDINO COUNTY STORMWATER POLLUTION PREVENTION

■ Automotive services

Oil, grease, anti-freeze and other toxic automotive fluids often make their way into the San Bernardino County storm drain system, and do not get treated before reaching the Santa Ana River. This pollutes our drinking water and contaminates waterways, making them unsafe for people and wildlife. Follow these best management practices to prevent pollution, protect public health and avoid fines or legal action.

- **Storing Hazardous Waste:** Keep your liquid waste segregated. Many fluids can be recycled via hazardous waste disposal companies if they are not mixed. Store all materials under cover with spill containment or inside to prevent contamination of rainwater runoff.
- **Proper Disposal of Hazardous Waste:** Recycle used motor oil and oil filters, anti-freeze and other hazardous automotive fluids, batteries, tires and metal filings collected from grinding/polishing auto parts. Contact a licensed hazardous waste hauler. For more recycling information, call (909) 386-8401.
- **Cleaning Auto Parts:** Scrape parts with a wire brush or use a bake oven rather than liquid cleaners. Arrange drip pans, drying racks and drain boards so that fluids are directed back into the sink or the fluid holding tank. Do not wash parts or equipment in a parking lot, driveway or street.
- **Preventing Leaks and Spills:** Place drip pans underneath to capture fluids. Use absorbent cleaning agents instead of water to clean work areas.
- **Metal Grinding & Polishing:** Keep a bin under your lathe or grinder to capture metal filings. Send uncontaminated filings to a scrap metal recycler for reclamation. Store metal filings in a covered container or indoors.
- **Cleaning Spills:** Follow your hazardous materials response plan, as filed with your local fire department or other hazardous materials authority. Be sure that all employees are aware of the plan and are capable of implementing each phase of the plan. Use dry methods for spill cleanup (sweeping, absorbent materials, etc.). To report serious spills, call 911.
- **Washing vehicles:** Wash vehicles where the wash water can soak into grass, gravel or be diverted to nearby landscaping, away from the street and storm drains. Wash vehicles at a designated wash rack that is connected to the sanitary sewer or take vehicles to a professional car wash. Use soaps, cleaners and detergents that are labeled phosphate free or biodegradable. The safest products for the environment are vegetable based or citrus-based soaps.



For more information about how you can prevent stormwater pollution:
www.sbcountystormwater.org



SAN BERNARDINO COUNTY STORMWATER POLLUTION PREVENTION

■ Carpet cleaning:

Toxic chemicals and discharged waste water from carpet, drapery, furniture and window cleaning often make their way into the San Bernardino County storm drain system and do not get treated before reaching the Santa Ana River. This pollutes our drinking water and contaminates local waterways, making them unsafe for people and wildlife. Following these best management practices will prevent pollution, comply with regulations and protect public health.

These guidelines apply even if the cleaning products are labeled “nontoxic” or “biodegradable”. Although these products may be less harmful to the environment, they can still have harmful effects if they enter the storm drain untreated.

- **Dispose of wastewater properly:** Wastewater from cleaning equipment must be discharged into a sink, toilet, or other drain connected to the sanitary sewer system within sanitary sewer discharge limits, or hauled off and disposed of properly. Wastewater should never be discharged into a street, gutter, parking lot or storm drain.
- **Filter wastewater:** Carpet cleaning wastewater should be filtered before discharging it to the sanitary sewer since fibers and other debris in the wastewater can clog pipes. The filtered material can be disposed of in the garbage, as long as the waste is not contaminated with hazardous pollutants.

For more information about how you can prevent stormwater pollution:
www.sbcountystormwater.org



SAN BERNARDINO COUNTY STORMWATER POLLUTION PREVENTION

■ Commercial landscape maintenance:

Yard waste, sediments and toxic lawn and garden chemicals used in commercial landscape maintenance often make their way into the San Bernardino County storm drain system and do not get treated before reaching the Santa Ana River. This pollutes our drinking water and contaminates local waterways, making them unsafe for people and wildlife. Follow these best management practices to prevent pollution, protect public health and avoid fines or legal action.

- **Recycle Yard Waste:** Recycle leaves, grass clippings and other yard waste. Do not blow, sweep, rake or hose yard waste into the street. Let your customers know about grass cycling --the natural recycling of grass by leaving clippings on the lawn when mowing instead of using a grass catcher. Grass clippings will quickly decompose, returning valuable nutrients to the soil. You can get more information at www.ciwmb.ca.gov/Organics.
- **Use Fertilizers, Herbicides & Pesticides Safely:** Fertilizers, herbicides and pesticides are often carried into the storm drain system by sprinkler runoff. Use natural, non-toxic alternatives to traditional garden chemicals. If you must use chemical fertilizers, herbicides, or pesticides spot apply rather than blanketing entire areas, avoid applying near curbs and driveways and never apply before a rain.
- **Recycle Hazardous Waste:** Pesticides, fertilizers, herbicides and motor oil contaminate landfills and should be disposed of through a Hazardous Waste Facility. For information on proper disposal, call (909) 386-8401.
- **Use Water Wisely:** Conserve water and prevent runoff by controlling the amount of water and direction of sprinklers. Sprinklers should be on long enough to allow water to soak into the ground but not so long as to cause runoff. Periodically inspect, fix leaks and realign sprinkler heads.
- **Planting:** Plant native vegetation to reduce the need of water, fertilizers, herbicides and pesticides.
- **Prevent Erosion:** Erosion washes sediments, debris and toxic runoff into the storm drain system, polluting waterways. Prevent erosion and sediment runoff by using ground cover, berms and vegetation down-slope to capture runoff. Avoid excavation or grading during wet weather.
- **Store Materials Safely:** Keep landscaping materials and debris away from the street, gutter and storm drains. On-site stockpiles of materials should be covered with plastic sheeting to protect from rain, wind and runoff.



For more information about how you can prevent stormwater pollution:

www.sbcountystormwater.org



SAN BERNARDINO COUNTY STORMWATER POLLUTION PREVENTION

■ Construction & development:

Soil, cement wash, asphalt, oil and other hazardous debris from construction sites often make their way into the San Bernardino County storm drain system, and flow untreated into local waterways. Follow these best management practices to prevent pollution, protect public health and avoid fines or legal action.

- **Store Materials Safely:** Keep construction materials and debris away from the street, gutter and storm drains. Cover exposed stockpiles of soil, sand or gravel and excavated material with plastic sheeting, protected from rain, wind and runoff.
- **Preventing Erosion:** Avoid excavation or grading during wet weather. Plant temporary vegetation or add hydro mulch on slopes where construction is not immediately planned, and permanent vegetation once excavation and grading are complete. Construct diversion dikes to channel runoff to a detention basin and around the construction site. Use gravel approaches where truck traffic is frequent to reduce soil compaction and limit the tracking of sediment into the streets. For more information on erosion control, call (909) 799-7407.
- **Cleaning & Preventing Spills:** Use a drip pan and funnel when draining or pouring fluids. Sweep up dry spills, instead of hosing. Be ready for spills by preparing and using spill containment and cleanup kits that include safety equipment and dry cleanup materials such as kitty litter or sawdust. To report serious spills, call 911.
- **Maintaining Vehicles & Equipment:** Maintain and refuel vehicles and equipment at a single location on-site, away from the street, gutter and storm drains. Perform major equipment repairs and washings off-site. Inspect vehicles and equipment frequently for leaks, and prevent leaks from stored vehicles by draining gas, hydraulic oil, transmission, and brake and radiator fluids.
- **Ordering Materials & Recycling Waste:** Reduce waste by ordering only the amounts of materials needed for the job. Use recycled or recyclable materials whenever possible. You can recycle broken asphalt, concrete, wood, and cleared vegetation. Dispose of hazardous materials through a hazardous waste hauler or other means in accordance with the construction permit. Non-recyclable materials should be taken to a landfill or disposed of as hazardous waste. For recycling and disposal information, call (909) 386-8401.
- **Concrete and mortar application:** Never dispose of cement washout into driveways, streets, gutters or drainage ditches. Wash concrete mixers and equipment only in specified washout areas, where the water flows into lined containment ponds. Cement wash water can be recycled by pumping it back into cement mixers for reuse.



For more information about how you can prevent stormwater pollution:

www.sbcountystormwater.org



SAN BERNARDINO COUNTY STORMWATER POLLUTION PREVENTION

■ Food & Restaurants:

Food waste, grease, cleaning fluids, mop water and trash from restaurant operations often make their way into the San Bernardino County storm drain system, and do not get treated before reaching the Santa Ana River. This pollutes our drinking water and contaminates waterways, making them unsafe for people and wildlife. Follow these best management practices to prevent pollution, protect public health and avoid fines or legal action.

- **Cleaning & Maintenance:** Clean equipment, floor mats, filters and garbage cans in a mop sink, wash rack or floor drain connected to the sewer through a grease trap. Don't wash them or pour wash water in a parking lot, alley, sidewalk or street. Sweep outside areas and put the debris in the garbage, instead of sweeping or hosing it into the parking lot or street.
- **Recycle oil & grease:** Oil and grease wastes can be recycled. Look in the yellow pages for rendering companies, or call (909) 386-8401 for disposal information. Don't pour oil or grease into sinks, floor drains or onto a parking lot or street. Keep grease bins covered and contained.
- **Dumpster areas:** Keep dumpster lids closed and the areas around them clean. Do not fill with liquid waste or hose them out. Call your trash hauler to replace any dumpsters that are damaged or leak. Do not wash down or steam clean trash enclosure area or trash bin unless you collect the water and dispose of it into the sanitary sewer. Hire a mobile pressure wash business that is familiar with the storm water regulations to clean these areas and make sure they provide you with a record of proper wastewater disposal.
- **Managing spills:** Use dry methods for spill cleanup, sweeping and using cat litter instead of hosing. Have spill containment and cleanup kits available for possible spills on your property. To report serious toxic spills, call (800) 33-TOXIC.
- **Handling toxic chemicals:** Dispose of all unwanted toxics materials like cleaners, solvents and detergents through a hazardous waste hauler. These items are not trash. Use non-toxic cleaning products whenever possible. For information on hazardous waste pickup, call (909) 386-8401.



For more information about how you can prevent stormwater pollution:
www.sbcountystormwater.org



SAN BERNARDINO COUNTY STORMWATER POLLUTION PREVENTION

■ General industrial & manufacturing businesses:

If you own, manage or help operate a business, especially an industrial or manufacturing company, you can help reduce storm water pollution. From environmentally friendly cleaning and maintenance activities, to recycling hazardous waste materials, businesses can do a lot to prevent storm water pollution.

- Review your cleaning and maintenance activities to look for ways to reduce runoff into the storm drain system, especially in outdoor areas like parking lots, loading docks and maintenance yards. Keep trash enclosure swept and trash bin lids closed.
- Train employees to wash vehicles and equipment indoors in a wash rack that is connected to the sanitary sewer or off-site at a commercial wash facility. Train janitorial staff to dispose of floor cleaning water in the sewer and not into the parking lot. Make sure that cooling towers, boilers, compressors, water softeners and other process equipment are connected to the sanitary sewer and do not discharge wastewater into the parking lot.
- If you use hazardous materials in your everyday business, like ink and solvents for commercial printing, or polishes and chemicals for car detailing or manufacturing after-market accessories, do not put these hazardous materials in the trash or pour them into the gutter. Take them to be recycled safely. Store chemicals, wastes, raw materials and contaminated equipment indoors or in a covered, spill contained area, to prevent exposure of these materials to storm water. For information on proper hazardous waste disposal, call (909)386-8401.
- Take advantage of less-toxic alternatives to dangerous chemicals. From detergents to drain openers, there are a lot of ways to get the same or better result without having to rely toxic substances.
- Looking for raw materials? San Bernardino County Materials Exchange Program, or [SBCoMax](#) is a partnership between the County and the California Integrated Waste Management Board, for businesses to provide used but usable materials to those interested in obtaining them. The program helps divert used materials from landfills, saves resources and can save you money.

For more information about how you can prevent stormwater pollution:

www.sbcountystormwater.org



SAN BERNARDINO COUNTY STORMWATER POLLUTION PREVENTION

■ **Mobile vehicle maintenance**

Wash in a designated area that has been bermed up to contain the wash water.

Common water control devices are: recycling systems; pretreatment or sewer discharge systems; limited recycling systems; wash pits(portable vinyl wash pads), vacuum sludge filtering systems; wet-dry vacuums, sump pumps; drain covers; portable dams; vacu-brooms; oil absorbent pads, booms, pillows, and tubes; plastic sheeting; filter tubs; buckets; pans; and squeegees.

When cleaning engines using chemical additives like soaps, solvents or degreasers, the cleaning must be performed at a facility that has the equipment to properly process the contaminated wastewater runoff, or using a leak-proof ground cover device that will catch and contain all contaminated wastewater runoff for later disposal in a manner that complies with city, county, state and federal codes.

Wastewater from cleaning equipment must be discharged into a sink, toilet, or other drain connected to the sanitary sewer

For more information about how you can prevent stormwater pollution:
www.sbcountystormwater.org



SAN BERNARDINO COUNTY STORMWATER POLLUTION PREVENTION

■ Regulatory information

The Federal Water Pollution Control Act prohibits the discharge of any pollutant to navigable waters from a point source unless the discharge is authorized by a National Pollutant Discharge Elimination System (NPDES) permit. The 1987 passage of the Water Quality Act established NPDES permit requirements for discharges of storm water. The NPDES permit program controls water pollution by regulating point sources that discharge pollutants into waters of the United States.

Industrial facilities and construction sites are regulated by the Regional Water Quality Control Board and State Water Resources Control Board, through general storm water permits. Most industrial, manufacturing or transportation businesses that store materials, products or equipment outdoors, or conduct vehicle washing or process operations outdoors are required to obtain coverage under the State Water Resources Control Board's General Industrial Activities Stormwater Permit. For more information about this permit, visit www.swrcb.ca.gov/stormwtr/industrial.html or contact your local storm water coordinator.

If your business conducts construction activities, including clearing, grading, stockpiling or excavation that results in soil disturbances of at least one acre, you are subject to the State Water Resources Control Board's General Construction Activities Stormwater Permit. To find out more about this storm water permit for construction, visit: www.swrcb.ca.gov/stormwtr/construction.html.

Cities and counties are regulated through permits issued by the Regional Boards. Since 1990, operators of large storm drain systems such as San Bernardino County's have been required to:

- Develop a storm water management program designed to prevent harmful pollutants from being dumped or washed by storm water runoff, into the storm water system, then discharged into local water bodies; and
- Obtain a National Pollutant Discharge Elimination System (NPDES) permit.

The NPDES permit programs in California are administered by the State Water Resources Control Board and by nine regional boards that issue NPDES permits and enforce regulations within their respective region.

San Bernardino County lies within the jurisdiction of the Santa Ana Region. This regional board issues a permit to the San Bernardino County Permittees, which includes the County of San Bernardino, San Bernardino County Flood Control District and incorporated cities of San Bernardino County. Since the program's inception, the County of San Bernardino has served as the principal permittee.



SAN BERNARDINO COUNTY STORMWATER POLLUTION PREVENTION

Documents & reports:

The following documents describe the regulations and programs for water quality in San Bernardino County. You can review the latest Basin Plan, National Pollutant Discharge Elimination System (NPDES) Permit and Drainage Area Management Plan (DAMP).

- **Basin Plans:** The document for each region of the State Water Quality Board's jurisdiction, including Santa Ana, is the Water Quality Control Plan, commonly referred to as the Basin Plan. It is the foundation for the regulatory programs of each regional board. The Basin Plan documents the beneficial uses of the region's ground and surface waters, existing water quality conditions, problems, and goals, and actions by the regional board and others that are necessary to achieve and maintain water quality standards.

▶ [Water Control Plan for the Santa Ana River Basin](#)

- **Municipal National Pollutant Discharge Elimination System (NPDES) Permits:** The permits of each region outline additional steps for a storm water management program and specify requirements to help protect the beneficial uses of the receiving waters. They require permittees to develop and implement Best Management Practices (BMPs) to control/reduce the discharge of pollutants to waters of the United States to the maximum extent practicable (MEP).

▶ [Santa Ana Regional Water Quality Control Board Municipal NPDES Permit Order No. R8-2002-0012](#)

- **Report of Waste Discharge:** The Report of Waste Discharge (ROWD) describes the San Bernardino Stormwater Program, implemented by the County and cities to comply with their jointly held stormwater permit. It is the principle policy and guidance document for the NPDES Stormwater Program.

▶ [Report of Waste Discharge 2000](#)

- **San Bernardino County Storm Water Program Annual Status Report:** The Annual Status Report is a requirement of the NPDES permit for submittal to the Regional Boards and United States Environmental Protection Agency. The report presents an analysis and assessment of permit compliance activities.

▶ [Annual report](#) - will be posted soon

For more information about how you can prevent stormwater pollution:

www.sbcountystormwater.org

MOBILE VEHICLE CLEANING & MAINTENANCE

DISCHARGE INTO THE STORM DRAIN, ACCIDENTAL OR NOT, CAN LEAD TO ENFORCEMENT ACTIONS, WHICH CAN INCLUDE FINES.

These best management practices will help you **prevent polluted water and other materials from flowing into the street, gutter and storm drain.**

WASH WATER DISPOSAL



HAZARDOUS WASTE SPILL CLEAN-UP & DISPOSAL



- ✓ When washing items contaminated by hazardous materials, wash water should be collected and hauled off-site for proper disposal.
- ✓ Wash in customers wash bay or pump wastewater to the wash bays' pretreatment system.

! Engine cleaning must be performed at a facility that has the equipment to properly process the contaminated wash water runoff.

- ✓ If a spill occurs, use an absorbent material such as kitty litter or absorbent pads.
- ✓ Clean up the excess. Properly dispose of absorbent material used to clean up spills - contact an approved hauler for assistance/disposal. Sweep work area thoroughly after cleaning.
- ✓ Keep toxics out of the trash by disposing of them properly, this includes absorbent materials used to clean up toxic waste spills. Toxic materials may include used motor oil and oil filters, antifreeze, batteries and gasoline. Make sure to maintain hauling records for all hazardous waste.



To report illegal dumping, call (877) WASTE18 or visit sbcountystormwater.org
To report toxic spills call (800) 33 TOXIC
To dispose of hazardous waste, call the CUPA Program (909) 386-8401

sbcountystormwater.org

Big Bear • Chino • Chino Hills • Colton • Fontana • Grand Terrace • Highland • Loma Linda • Montclair • Ontario • Rancho Cucamonga
Redlands • Rialto • San Bernardino • San Bernardino County • San Bernardino County Flood Control District • Upland • Yucaipa

PORTABLE TOILET BUSINESSES

Prevent potential waste spills from coming into contact with our waterways:

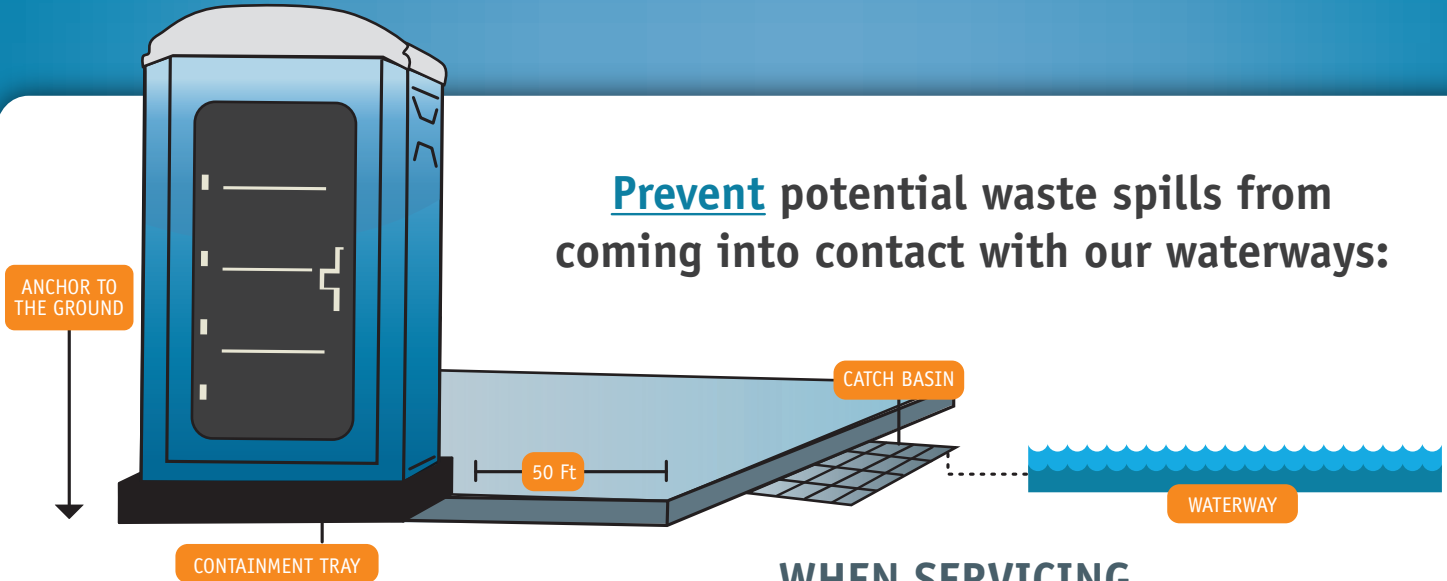

WHEN DELIVERING

- ✓ Site Portable Toilets at least 50 feet away from a catch basin or waterway.
- ✓ In high wind areas, secure the Portable Toilets by anchoring the unit securely to the ground.
- ✓ Equip Portable Toilets with a containment tray to prevent accidental overflow.



When there is potential for greater than normal usage, **remind** your clients to **request additional units** or **adjust the service schedule** to ensure sanitary conditions and **prevent overflow**.

WHEN SERVICING

- ✓ On the service vehicle:
 - Maintain the condition of all hoses, couplings, tanks, and equipment to prevent leaks or spills.
 - Properly store and handle potential contaminants (Portable Toilet waste, disinfectants, oils, detergents etc.) to prevent any spills or discharges from entering the street, gutter or catch basin.
- ✓ When rinsing or washing Portable Toilets, ensure that all waste water is captured in the containment tray to prevent waste water from entering the street, gutter or catch basin.
- ✓ Upon completion of the cleaning process, pump the captured water into the service vehicle.

WHAT IS STORMWATER POLLUTION?

Stormwater pollution is created when bacteria, organic matter, disinfectants, and suspended solids are transported by water or wind into the catch basins and storm drain system. The untreated urban runoff then flows directly into our lakes and rivers contaminating our communities with high levels of bacteria, posing a threat to public health and wildlife.

THANK YOU FOR BEING A RESPONSIBLE BUSINESS AND HELPING TO KEEP SAN BERNARDINO COUNTY CLEAN AND HEALTHY!

In the event of a spill or discharge to a storm drain or waterway, contact San Bernardino County Stormwater immediately: **(877) WASTE18** | sbcountystormwater.org/report
To dispose of hazardous waste call the San Bernardino County Fire Dept. - CUPA Program **(909) 386-8401**



sbcountystormwater.org

Big Bear • Chino • Chino Hills • Colton • Fontana • Grand Terrace • Highland • Loma Linda • Montclair • Ontario • Rancho Cucamonga • Redlands • Rialto • San Bernardino • San Bernardino County • San Bernardino County Flood Control District • Upland • Yucaipa

NEGOCIOS DE BAÑOS PORTÁTILES

Impida que los derrames potenciales de desechos entren en contacto con nuestras vías fluviales:



AL MOMENTO DE LA ENTREGA

- ✓ Coloque los Baños Portátiles a una distancia mínima de 50 pies de un sumidero o vía fluvial.
- ✓ En áreas de vientos fuertes, proteja los Baños Portátiles anclando la unidad en forma segura al suelo.
- ✓ Coloque la bandeja de contención abajo del Baño Portátil.



Cuando exista la posibilidad de un uso mayor de lo normal, **recuerde** a sus clientes **que soliciten unidades adicionales o que adapten el programa de mantenimiento** para garantizar las condiciones sanitarias y **prevenir desbordes**.

CUANDO SE REALIZE EL MANTENIMIENTO

- ✓ En el vehículo de servicio:
 - Mantenga en condiciones óptimas todas las mangueras acoples, tanques y equipo a fin de prevenir derrames.
 - Almacene y maneje en forma apropiada los contaminantes potenciales (desechos del Baño Portátil, desinfectantes, aceites, detergentes, etc) para impedir cualquier derrame o que se produzcan descargas hacia la calle, la alcantarilla o el sumidero.
- ✓ Al enjuagar o lavar los Baños Portátiles, asegúrese de que la bandeja de contención capture toda el agua residual, para impedir que ésta llegue a la calle, alcantarilla o sumidero.
- ✓ Al completar el proceso de limpieza, bombee el agua capturada en el vehículo de servicio.

¿QUÉ ES LA CONTAMINACIÓN DE AGUAS PLUVIALES?

La contaminación de aguas pluviales se crea cuando el agua o el viento transportan bacterias, materia orgánica, desinfectantes y sólidos suspendidos hacia los sumideros y el sistema de drenaje pluvial. Los residuos líquidos urbanos sin tratar luego fluyen directamente hacia los lagos y ríos contaminando nuestras comunidades con altos niveles de bacterias y plantean una amenaza para la salud pública y la vida silvestre.

GRACIAS POR SER UN NEGOCIO RESPONSABLE Y AYUDAR A MANTENER LIMPIO Y SALUDABLE EL CONDADO DE SAN BERNARDINO.

En caso de un derrame o descarga en un drenaje pluvial o vía fluvial, comuníquese de inmediato con San Bernardino County Stormwater: **(877) WASTE18** | sbcountystormwater.org/report

Para deshacerse de los residuos peligrosos llame al Condado de San Bernardino Departamento de Bomberos - programa CUPA **(909) 386-8401**

sbcountystormwater.org

Big Bear • Chino • Chino Hills • Colton • Fontana • Grand Terrace • Highland • Loma Linda • Montclair • Ontario • Rancho Cucamonga • Redlands • Rialto • San Bernardino • San Bernardino County • San Bernardino County Flood Control District • Upland • Yucaipa



GAS STATIONS

AN ILLEGAL DISCHARGE INTO THE STORM DRAIN, ACCIDENTAL OR NOT, CAN LEAD TO ENFORCEMENT ACTIONS, WHICH CAN INCLUDE FINES.

These best management practices will help you **prevent polluted water and other materials from flowing into the street, gutter and storm drain.**

WHEN CLEANING, USE DRY CLEAN-UP METHODS:

SWEEP TO REMOVE LITTER AND DEBRIS



USE RAGS AND ABSORBENTS FOR LEAKS AND SPILLS



PLACE CLEAN UP MATERIALS IN THE TRASH OR DISPOSE OF PROPERLY



SPILL CLEAN-UP

- ✓ **Stop the source of the spill immediately.** Be aware of the nearest storm drain location and ensure nothing can enter or be discharged into it.
- ✓ **Contain the spill.** Spill kit location must be properly marked and easily accessible. Train your personnel.
- ✓ **Clean up the excess.** Applied absorbent materials must be collected for re-use or proper disposal.

Keep hazardous materials out of the trash by disposing of them properly, this includes absorbent materials used to clean up toxic waste spills. **Hazardous materials may include used motor oil and oil filters, antifreeze, batteries and gasoline.** Keep containers with hazardous waste stored under a cover and on secondary containment.

TRASH AREAS

- ✓ **Place trash inside the bin** (preferably in sealed bags).
- ✓ **Prevent rainwater** from entering trash bins by keeping lids closed at all times or by placing the bins under a solid roof.

Pollutants from gas stations may make their way into the storm drain system. This pollutes our drinking water and contaminates waterways, making them unsafe for people and wildlife. Follow these best management practices to comply with regulations, prevent pollution and protect public health. **For more information about BMPs for gasoline services, visit cabmphandbooks.com.**



When pressure washing, ensure wash water does not leave the site or enter the storm drain by placing a capture device on or around the storm drain. Clean out the capture device and properly dispose of the wastes. To avoid fines, be sure to advise your pressure washers to comply with operating procedures for proper collection and disposal of wash water.

To report illegal dumping, call (877) WASTE18 or visit sbcountystormwater.org

To report toxic spills call 1(800) 33 TOXIC

To dispose of hazardous waste, call the San Bernardino County Fire Dept. - CUPA Program (909) 386-8401

sbcountystormwater.org

Big Bear • Chino • Chino Hills • Colton • Fontana • Grand Terrace • Highland • Loma Linda • Montclair • Ontario • Rancho Cucamonga
Redlands • Rialto • San Bernardino • San Bernardino County • San Bernardino County Flood Control District • Upland • Yucaipa

