





VIEW OF BUILDING 9 ALONG STREETER AVE. 1



VIEW OF PEDESTRIAN CONNECTIVITY ALONG STREETER AVE. 2



LOOKING NORTHEAST ON STREETER AVE. 3



LOOKING SOUTH ALONG STREETER AVE. 4

KEY MAP

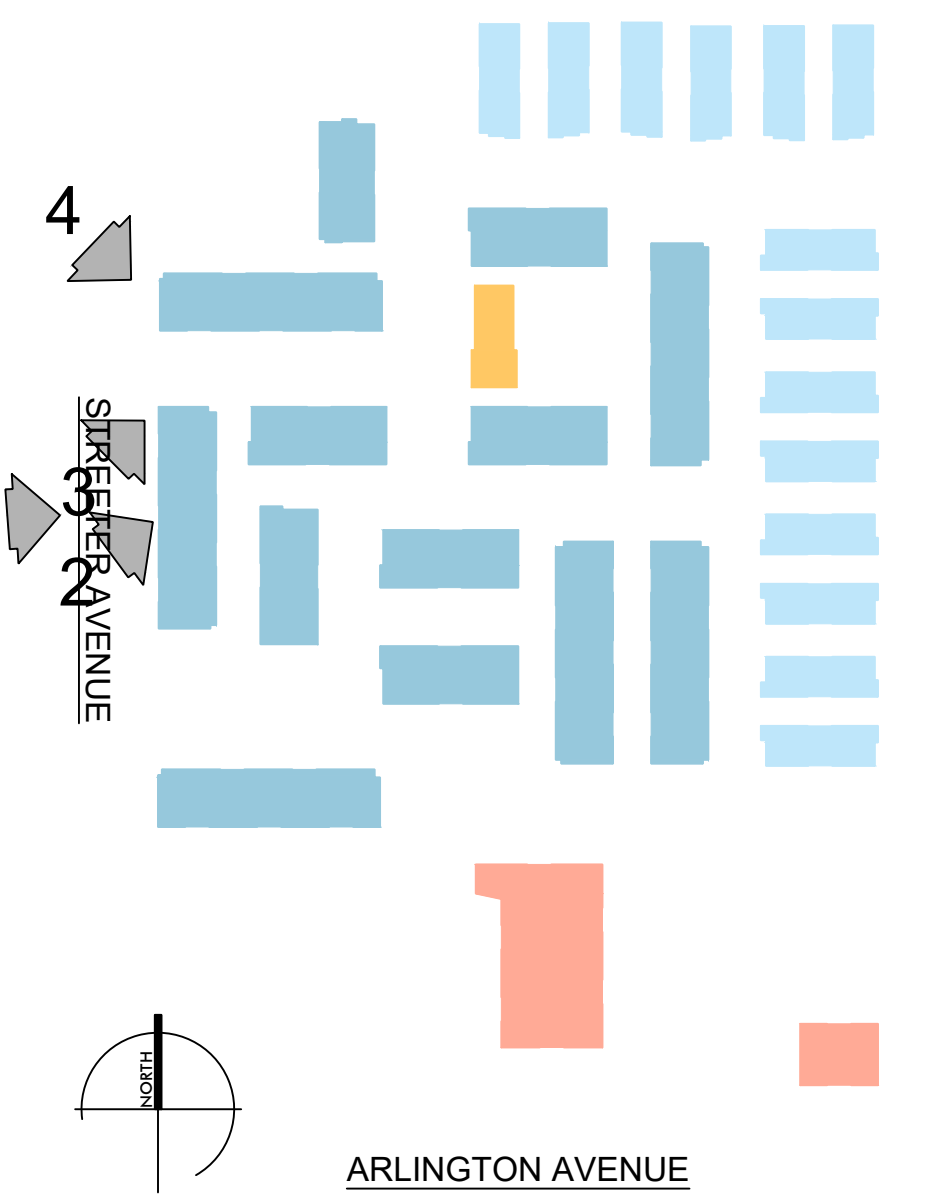



VIEW OF A TYPICAL TOWNHOME PEDESTRIAN WALKWAY 5



CLOSE-UP OF PROJECT CLUBHOUSE 6



CLOSEUP OF TOWNHOME FACING DOG PARK 7



CLOSE-UP VIEW OF BUILDING CORNER WITH ENHANCED MATERIALS 8

KEY MAP

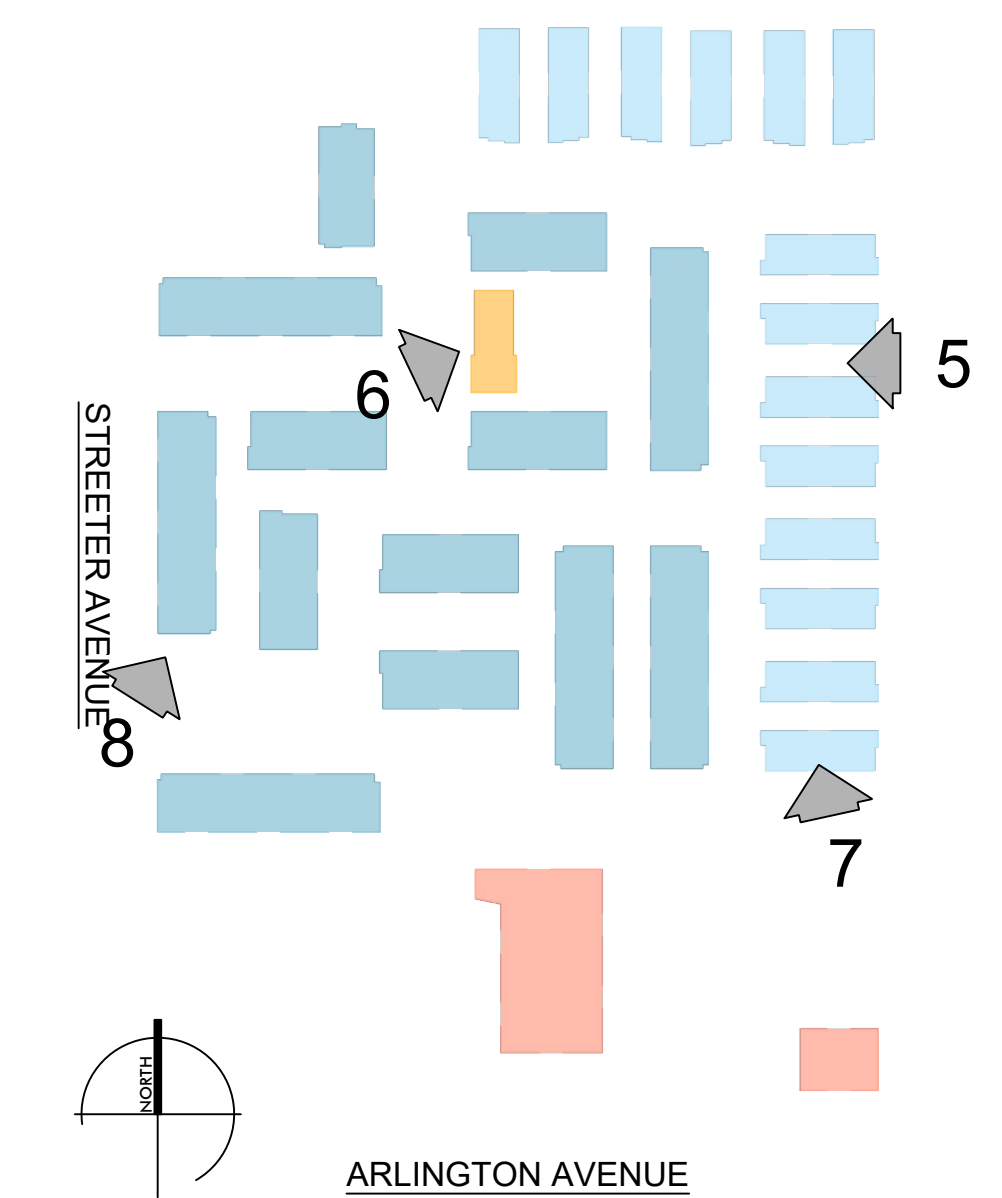

LEGEND



5x5' MIN. OPEN SPACE DIMENSION

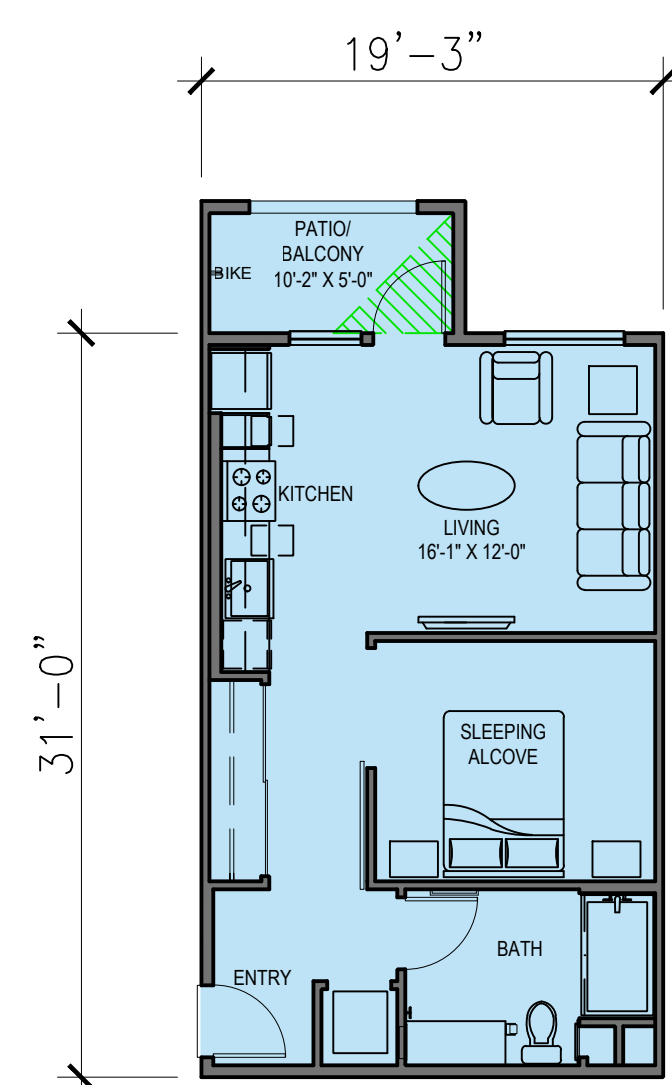

UNIT S1 - OPTION 1  
STUDIO - 1 BATH  
NET LIVABLE: 597 SQ. FT.  
PATIO/DECK: 51 SQ. FT.

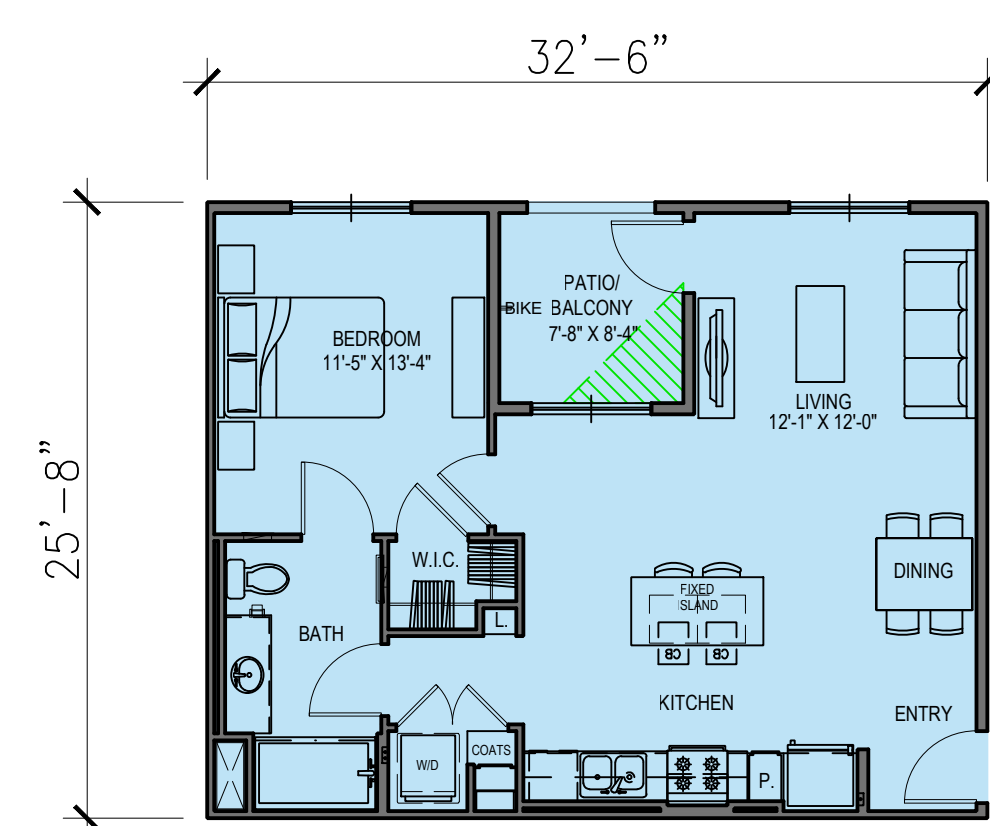

UNIT A1 - OPTION 1  
1 BED - 1 BATH  
NET LIVABLE: 770 SQ. FT.  
PATIO/DECK: 64 SQ. FT.

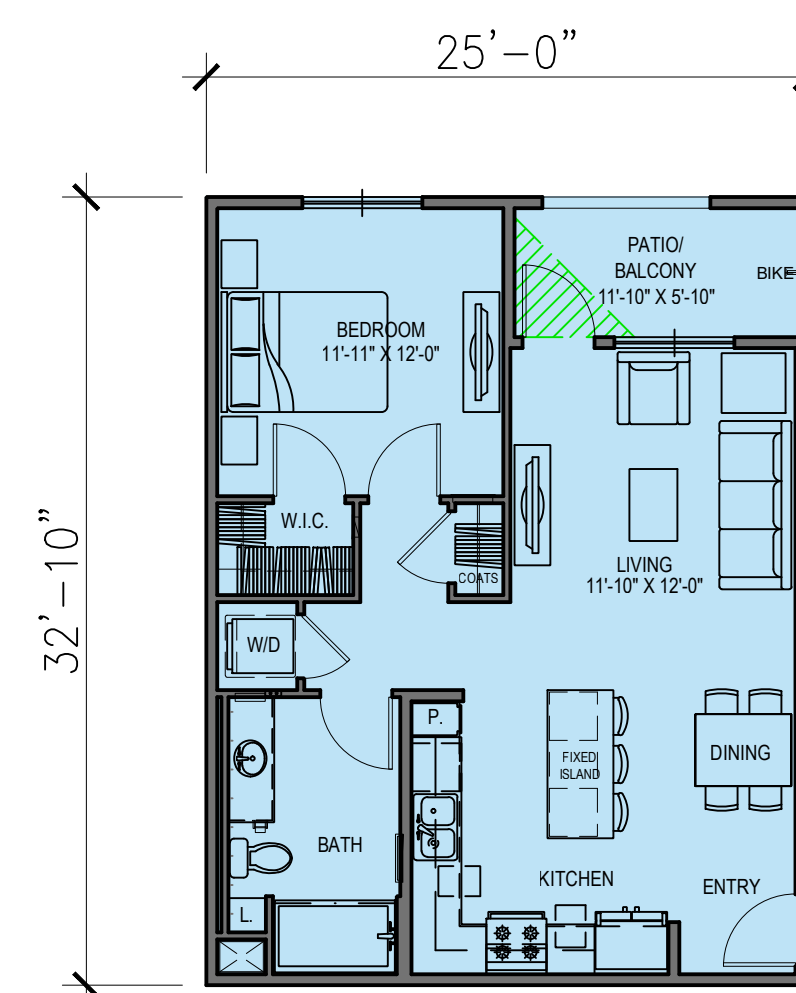

UNIT A2 - OPTION 1  
1 BED - 1 BATH  
NET LIVABLE: 745 SQ. FT.  
PATIO/DECK: 64 SQ. FT.

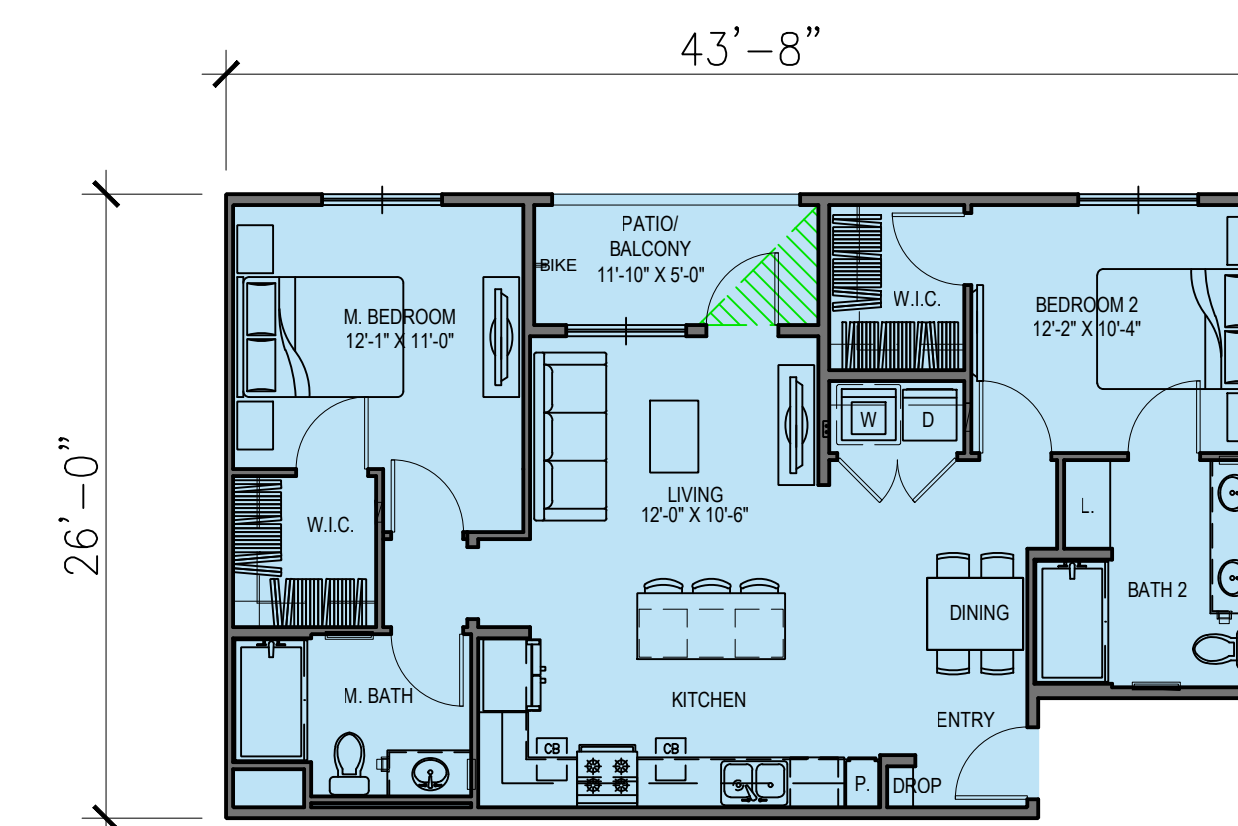

UNIT B1 - OPTION 1  
2 BED - 2 BATH CARRIAGE  
NET LIVABLE: 1015 SQ. FT.  
PATIO/DECK: 59 SQ. FT.

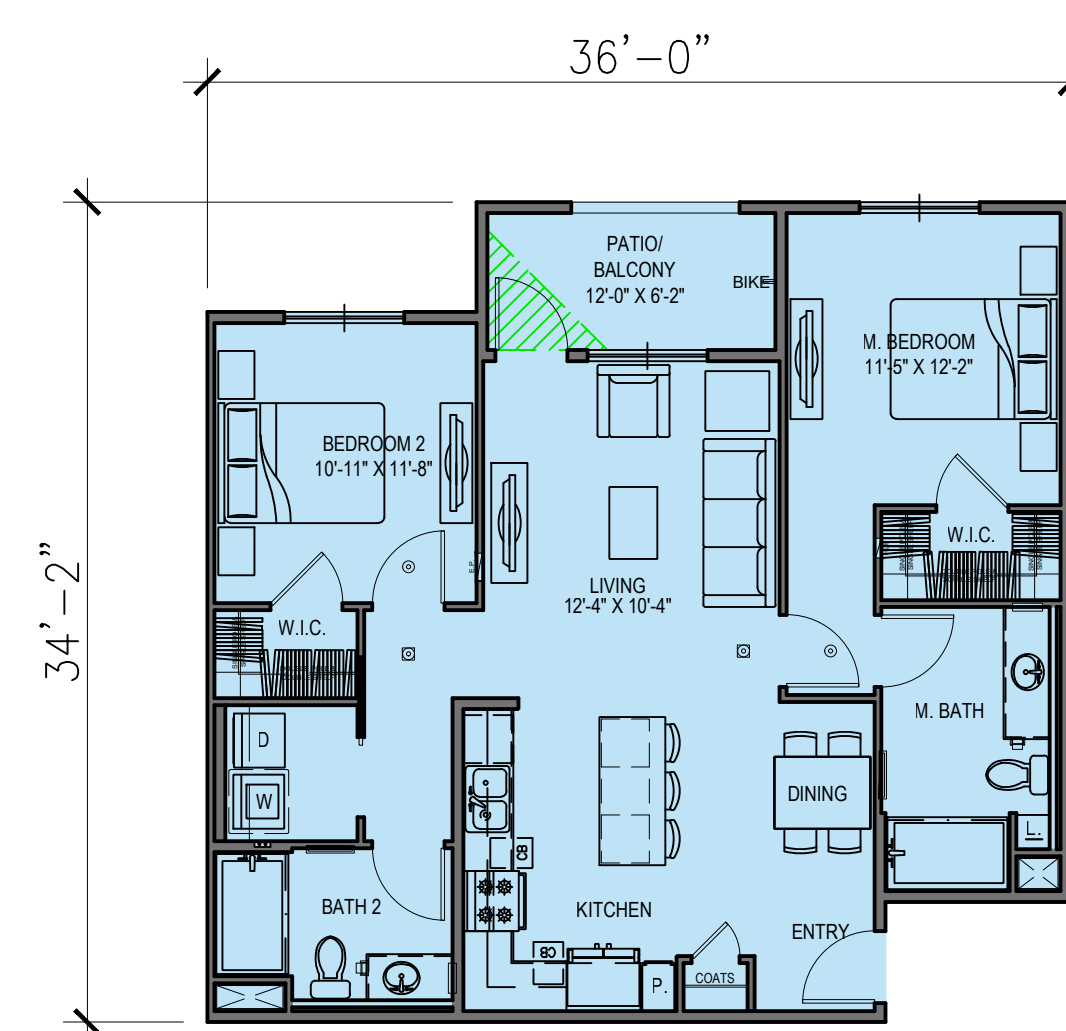

UNIT B2 - OPTION 1  
2 BED - 2 BATH  
NET LIVABLE: 1054 SQ. FT.  
PATIO/DECK: 69 SQ. FT.

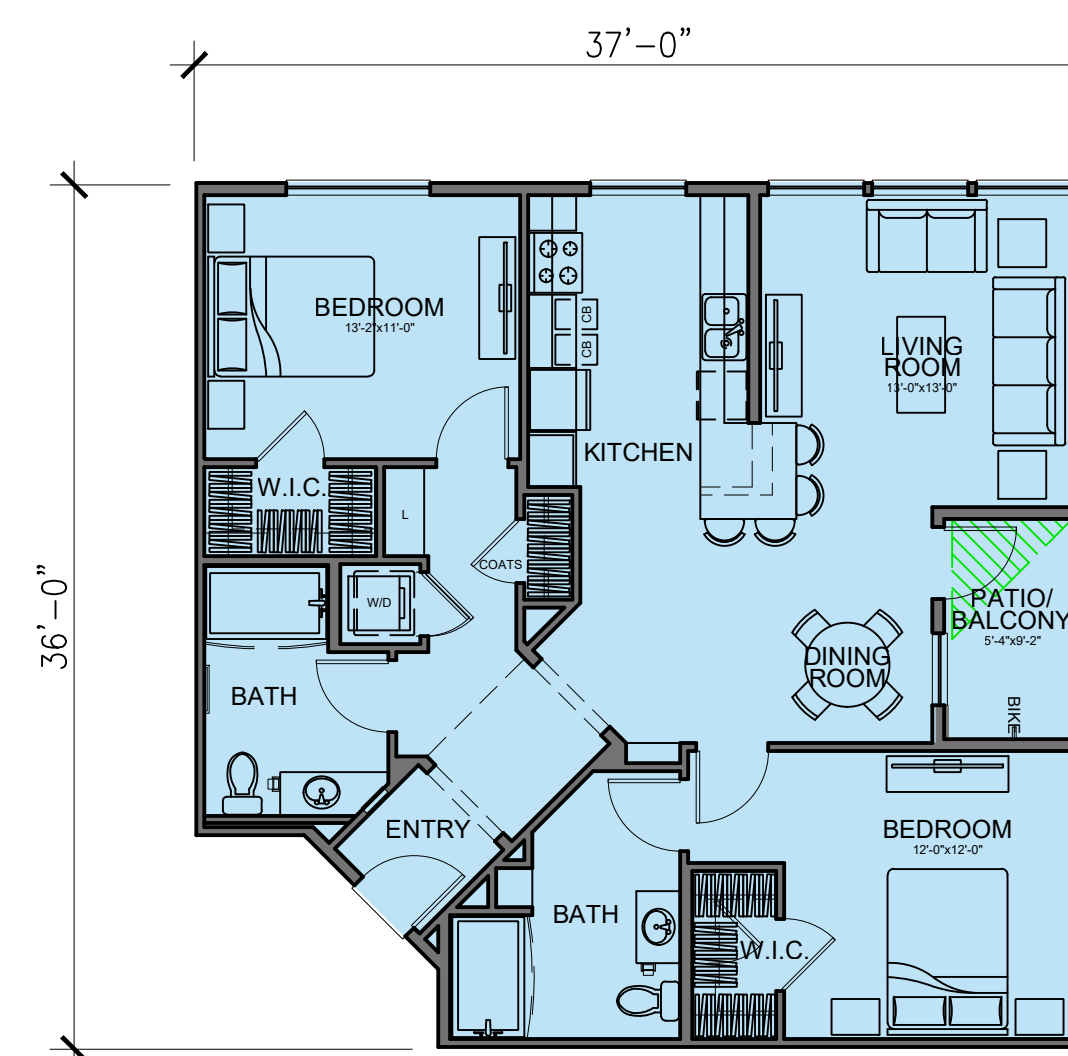

UNIT B4  
2 BEDROOM - 2 BATH  
UNIT AREA: 1205 SQ. FT.  
PATIO/ BALCONY: 50 SQ. FT.

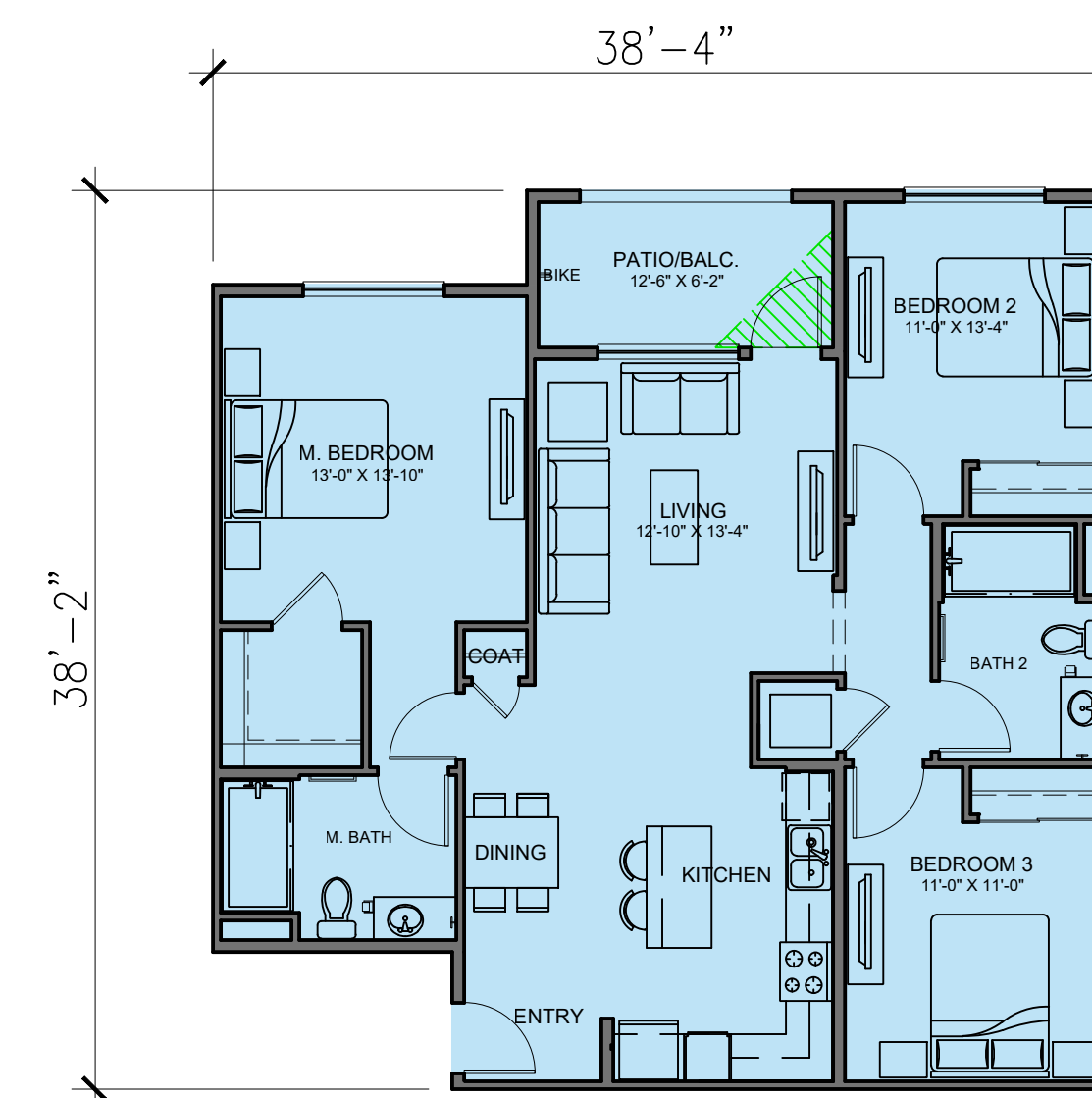

UNIT C1 - OPTION 1  
3 BED - 2 BATH  
NET LIVABLE: 1265 SQ. FT.  
PATIO/DECK: 77 SQ. FT.

LEGEND



5x5' MIN. OPEN SPACE DIMENSION

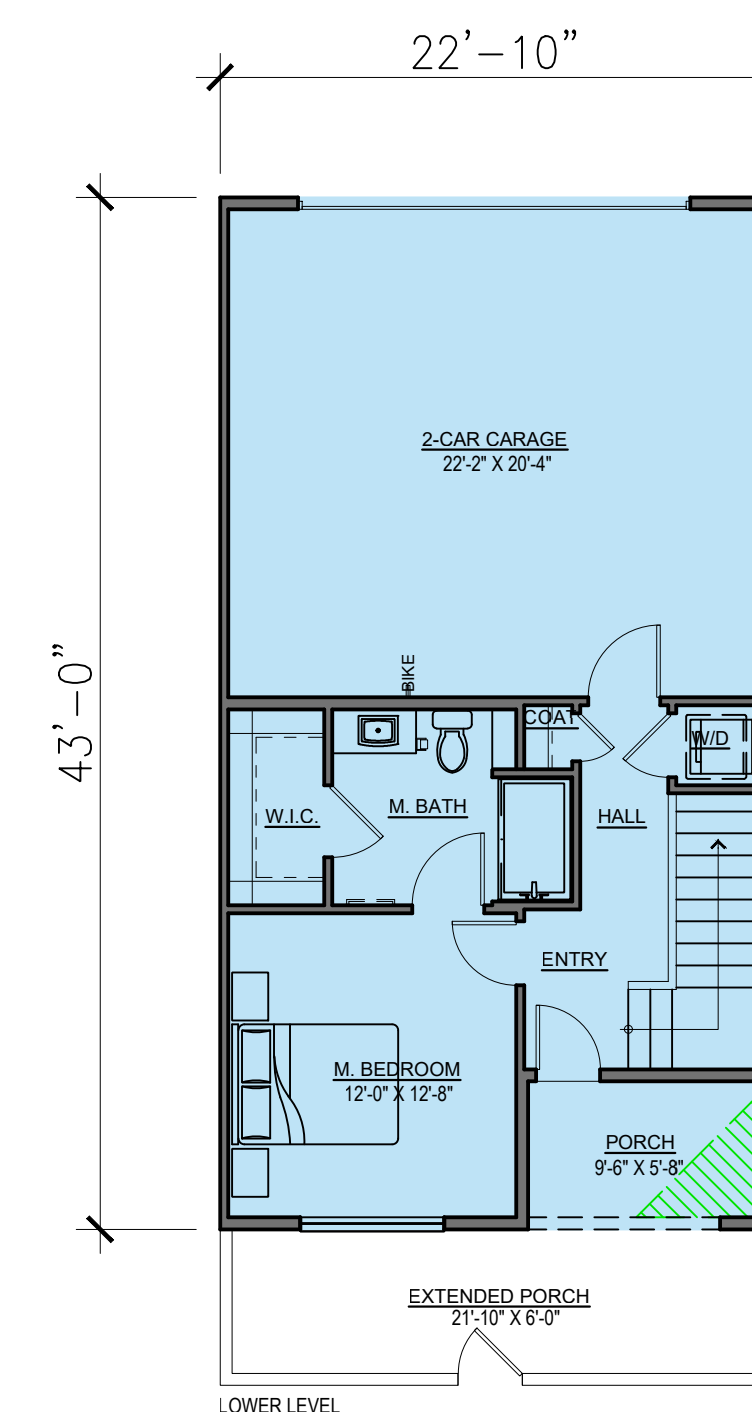
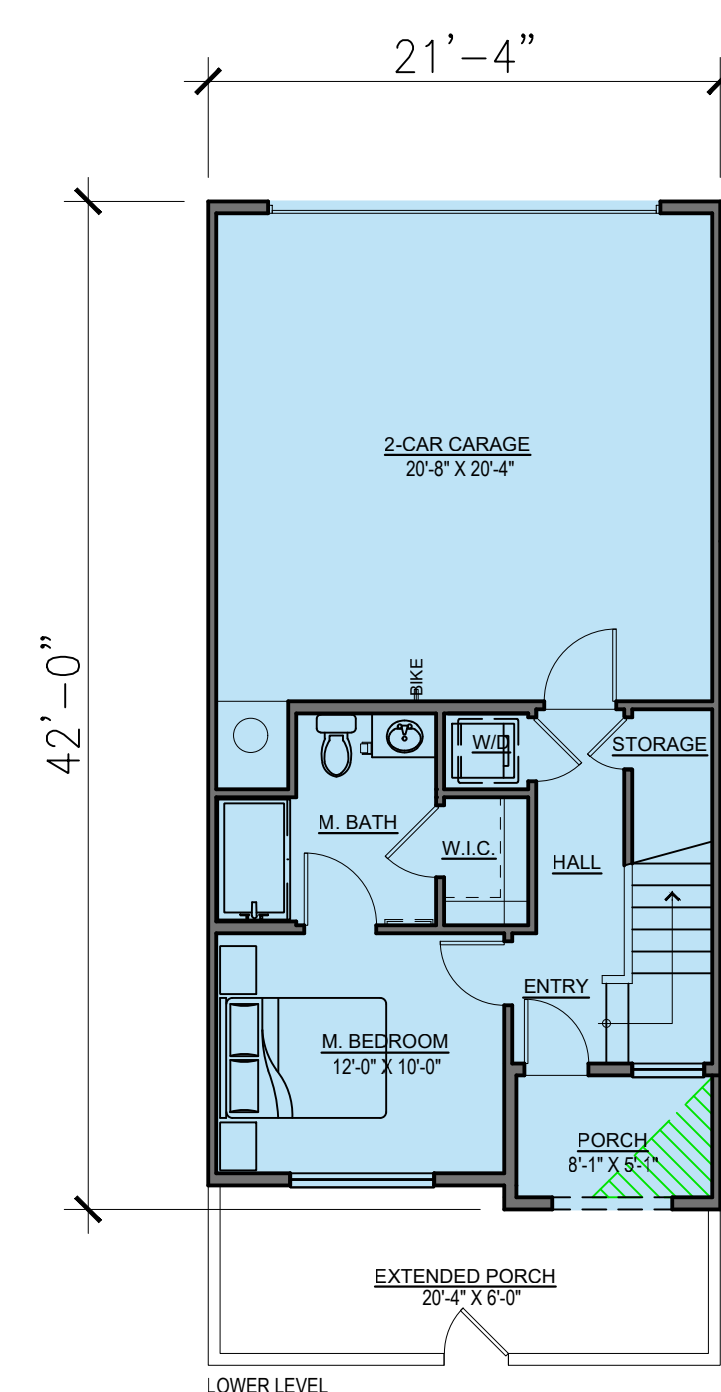
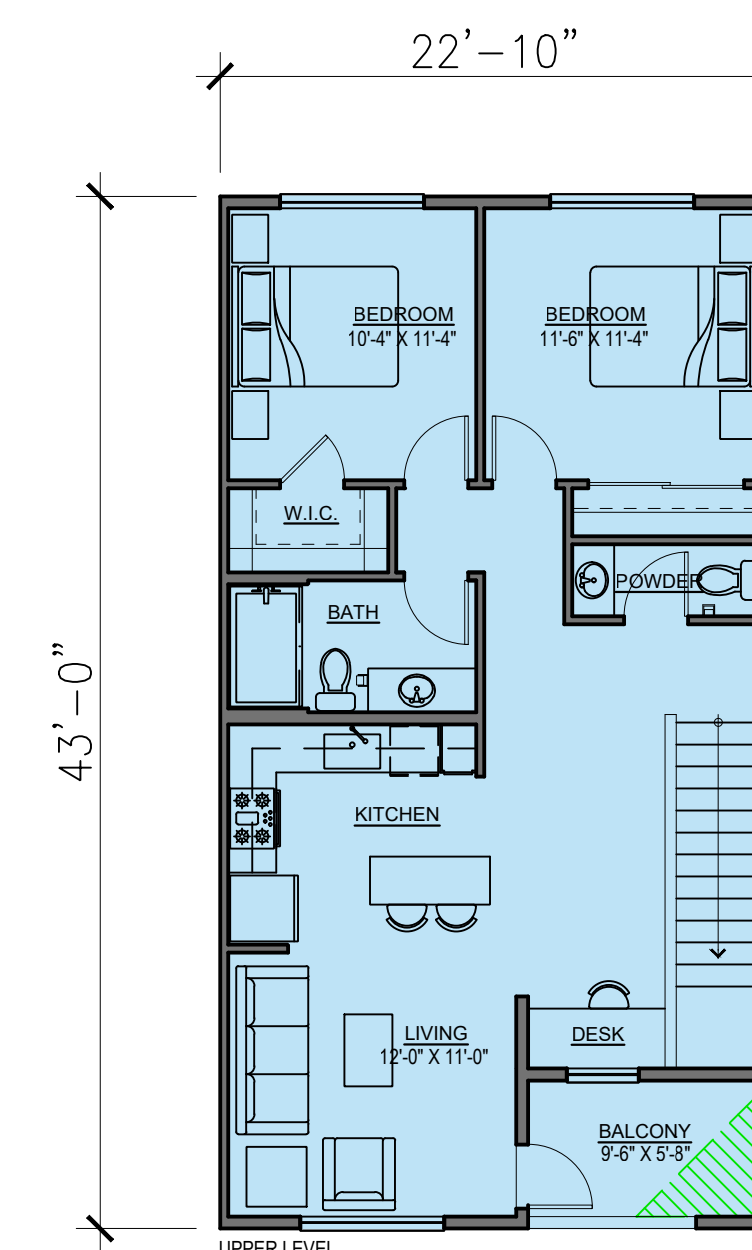
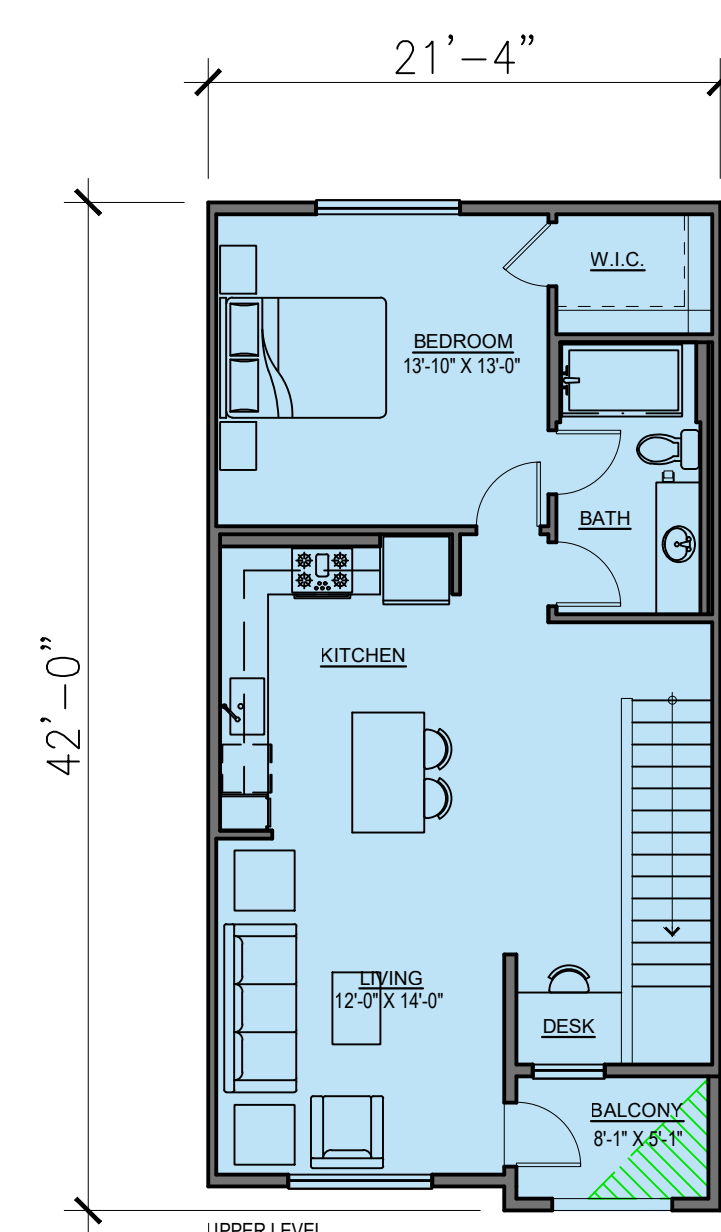

UNIT B3 - TOWNHOME  
2 BED - 2 BATH  
NET LIVABLE: 1162 SQ. FT.  
PATIO/DECK : 215 SQ. FT.

UNIT C2  
3 BED - 2.5 BATH  
NET LIVABLE: 1307 SQ. FT.  
PATIO/DECK : 243 SQ. FT.

**MATERIAL / COLOR LEGEND**

- 1 SPLIT FACE BLOCK W/ CAP
- 2 SLOPED METAL ROOF
- 3 METAL GATE
- A SW 6006 - BLACK BEAN

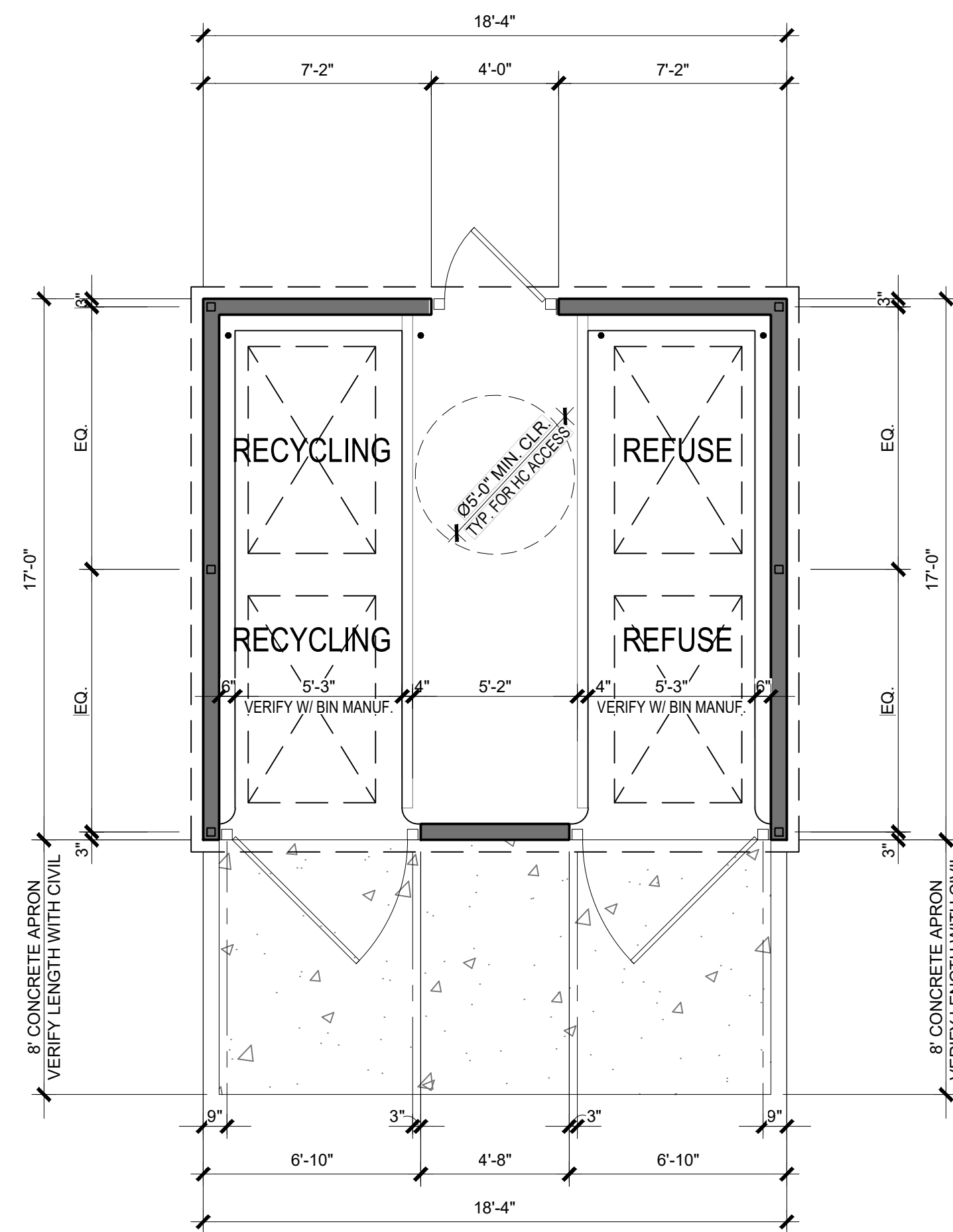

FLOOR PLAN 1

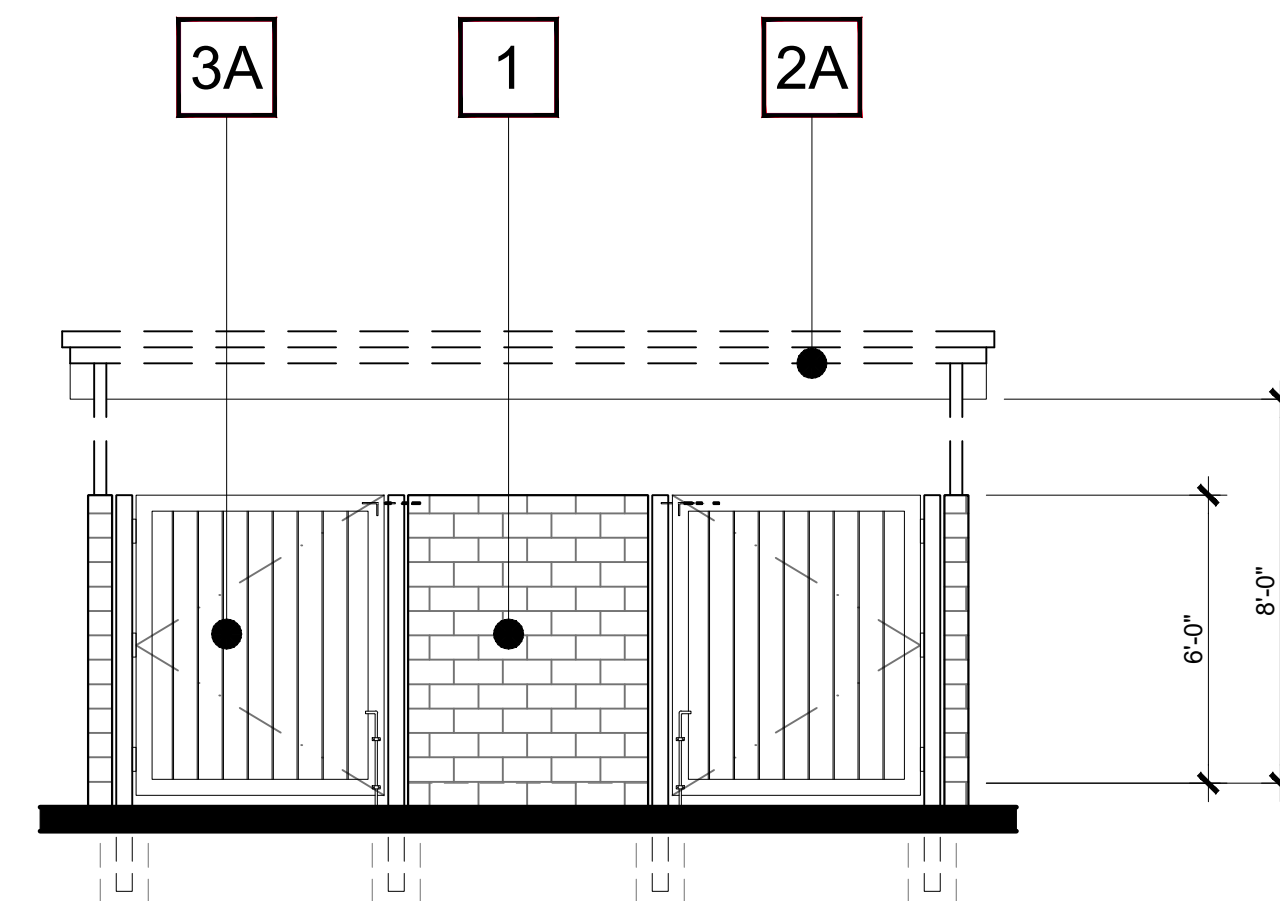

FRONT ELEVATION 2

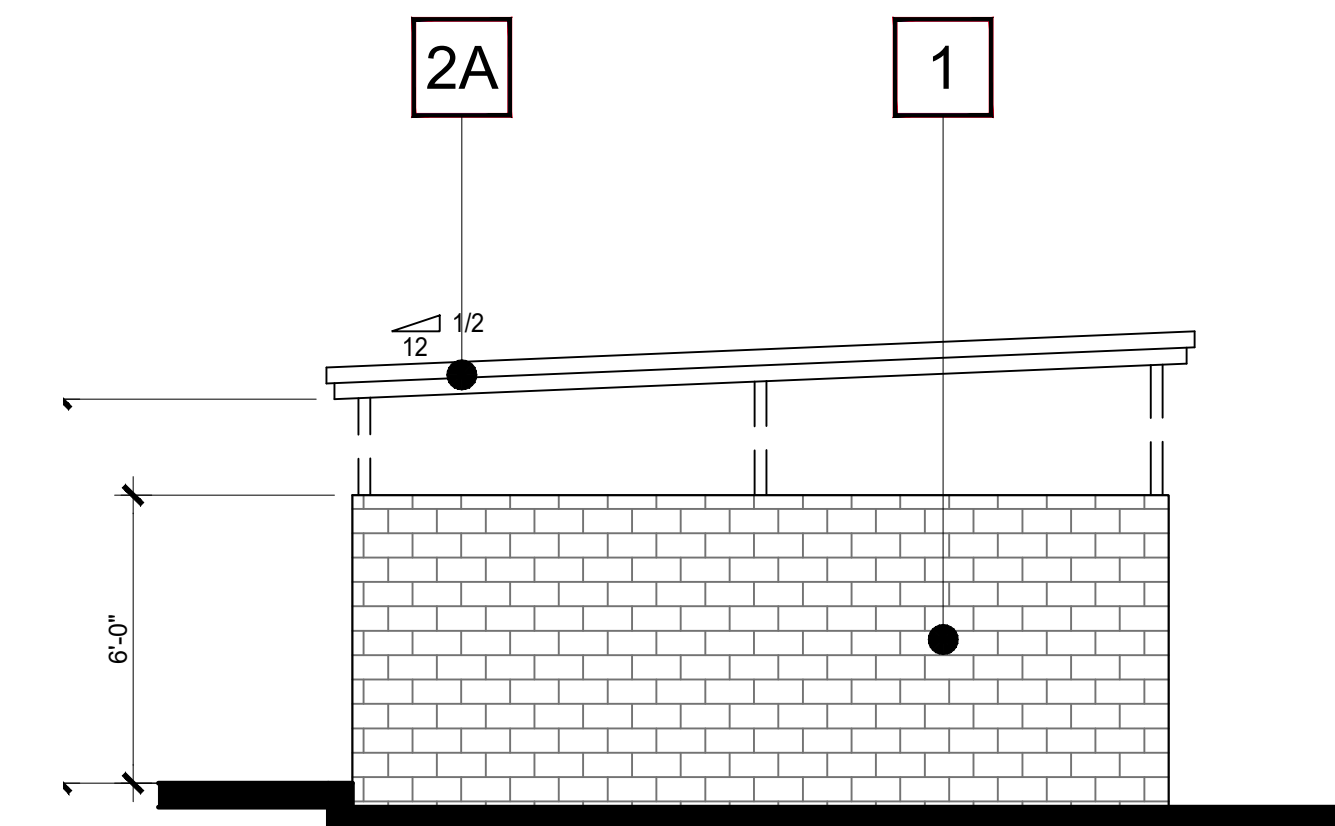

LEFT ELEVATION 3

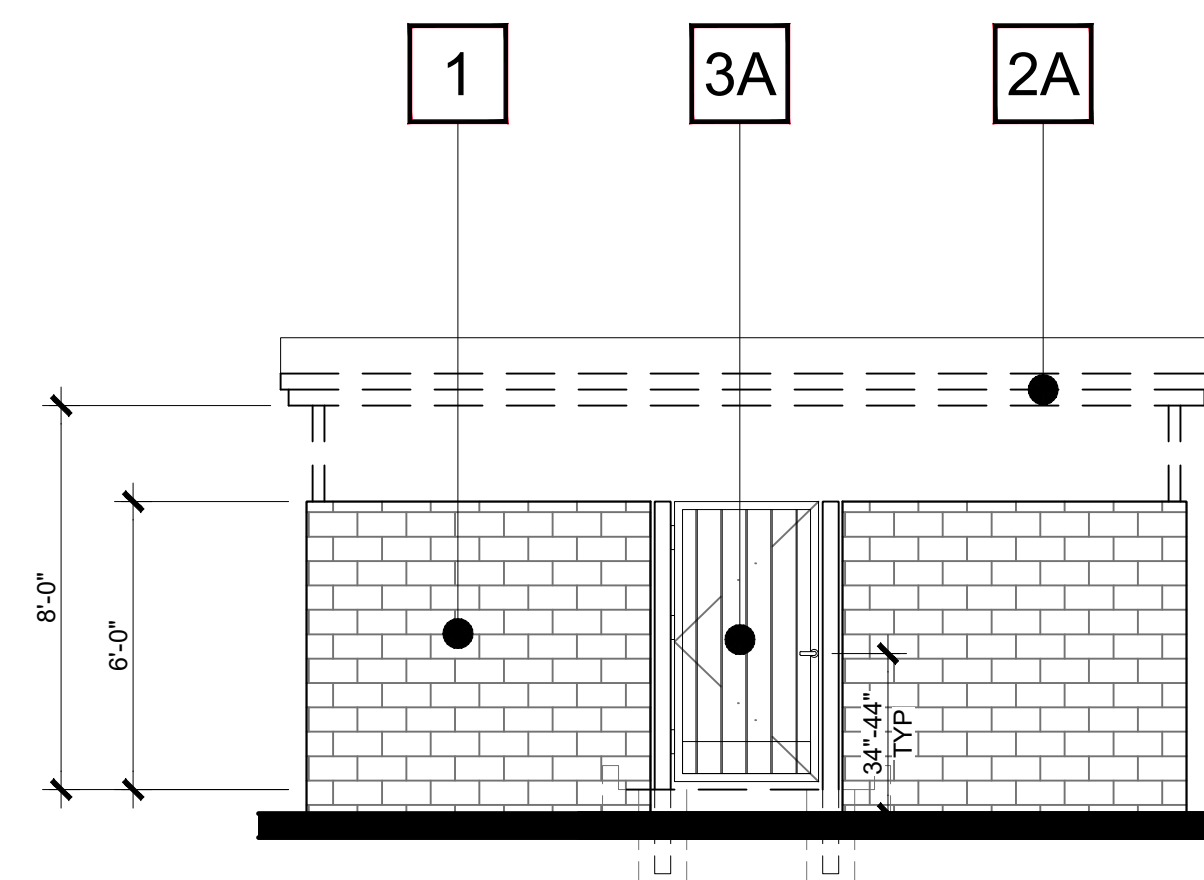

REAR ELEVATION 4

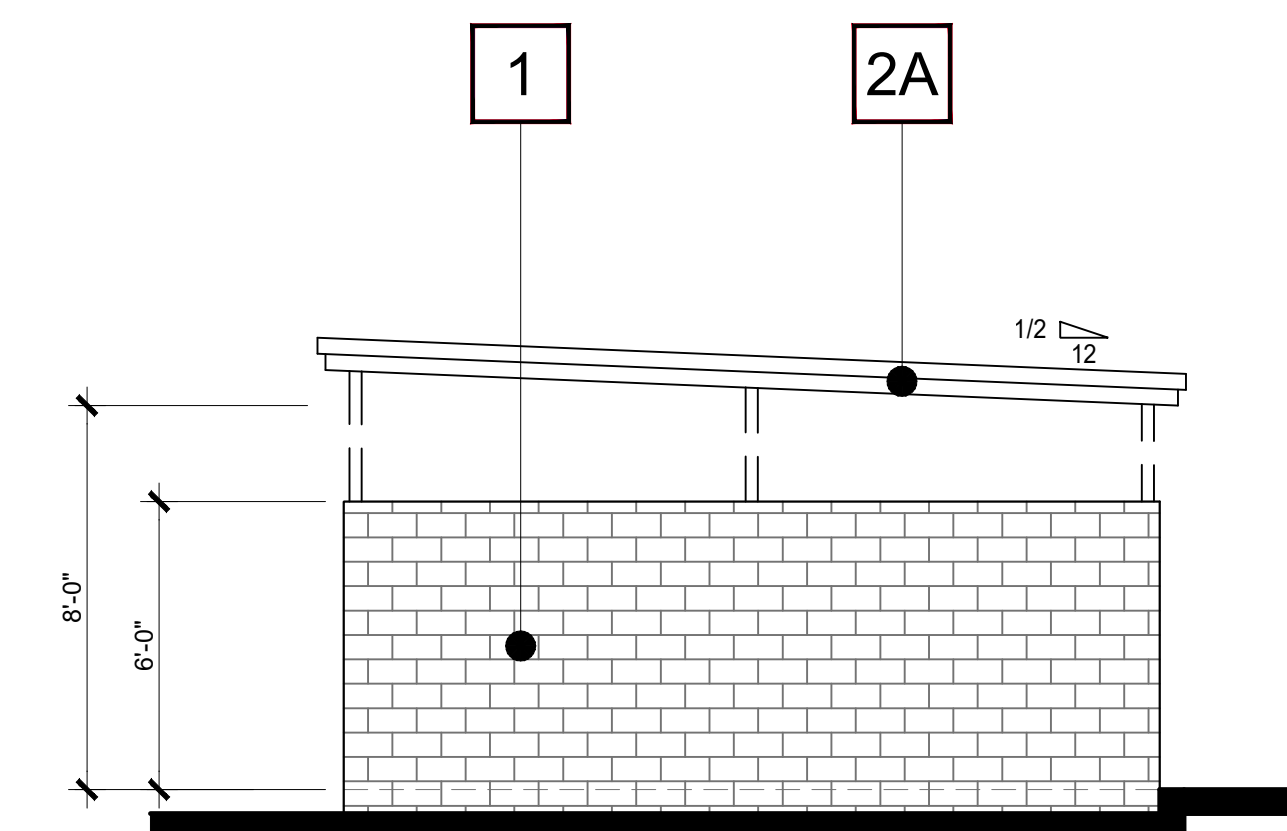

RIGHT ELEVATION 5



SAMPLE CARPORT IMAGES



SAMPLE SCREEN  
(DESIGN SUBJECT TO CHANGE)

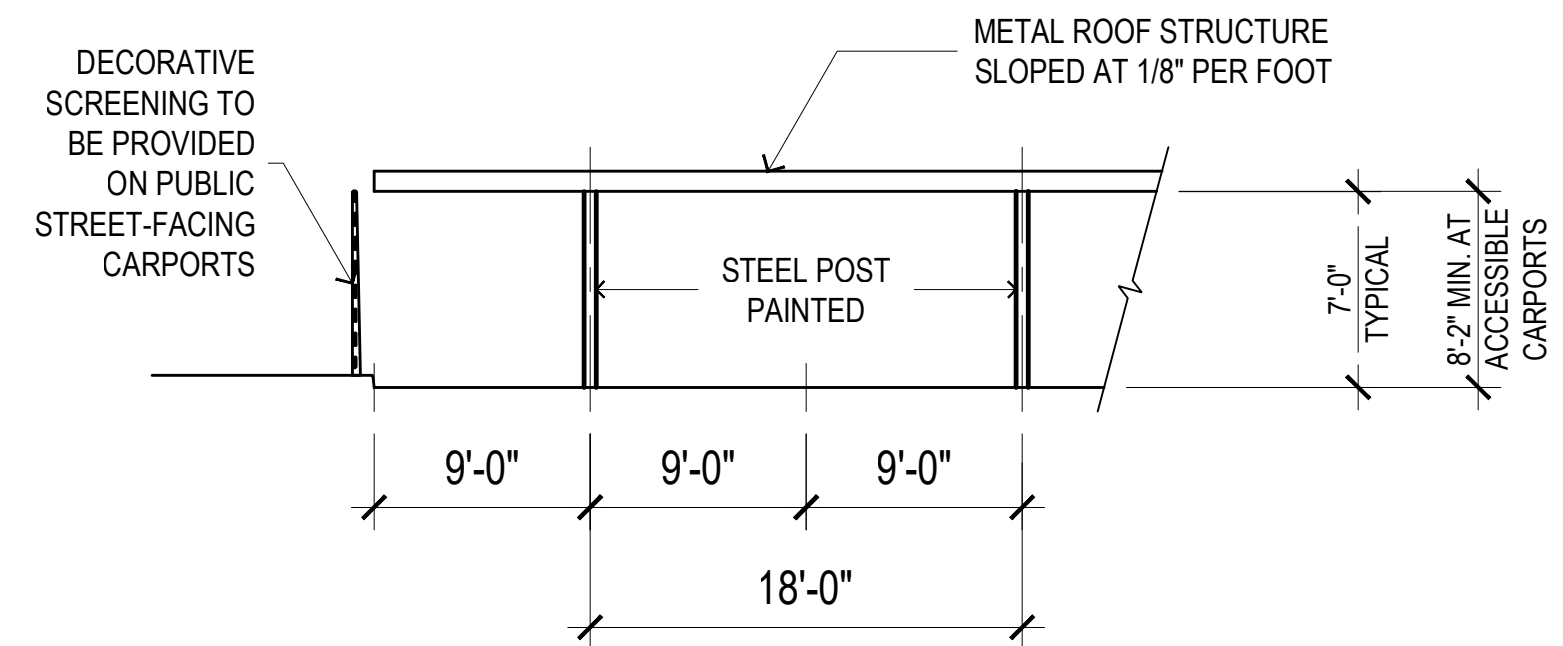

FRONT ELEVATION (TYP.) 1

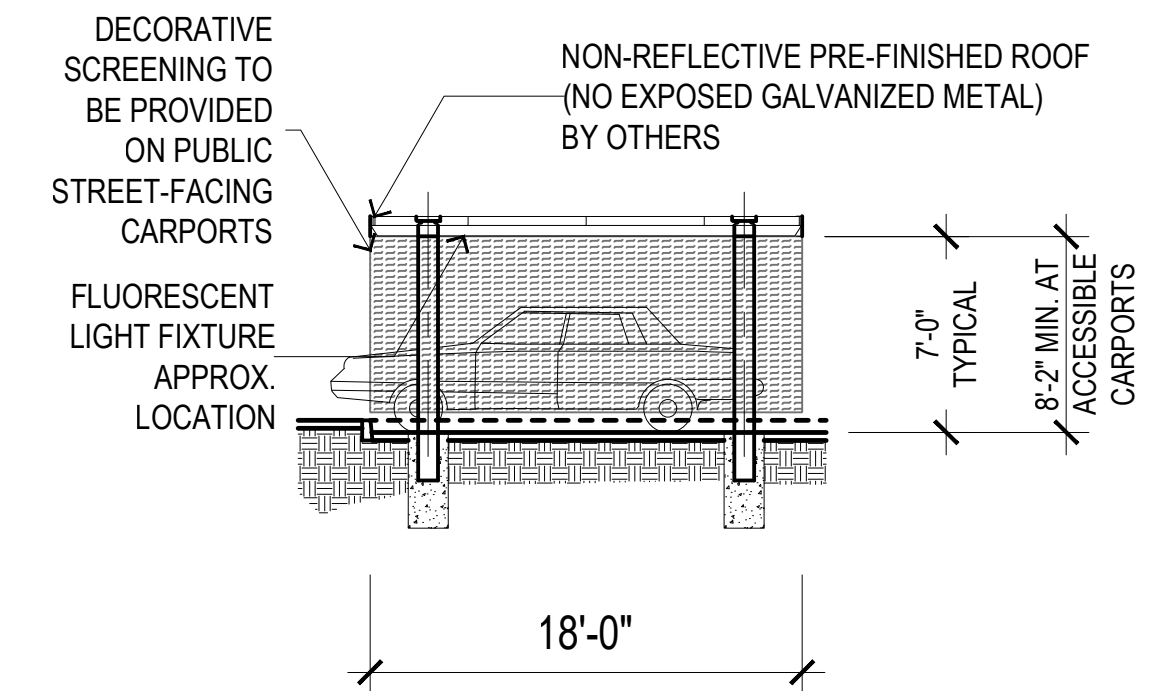

SIDE ELEVATION (TYP.) 2

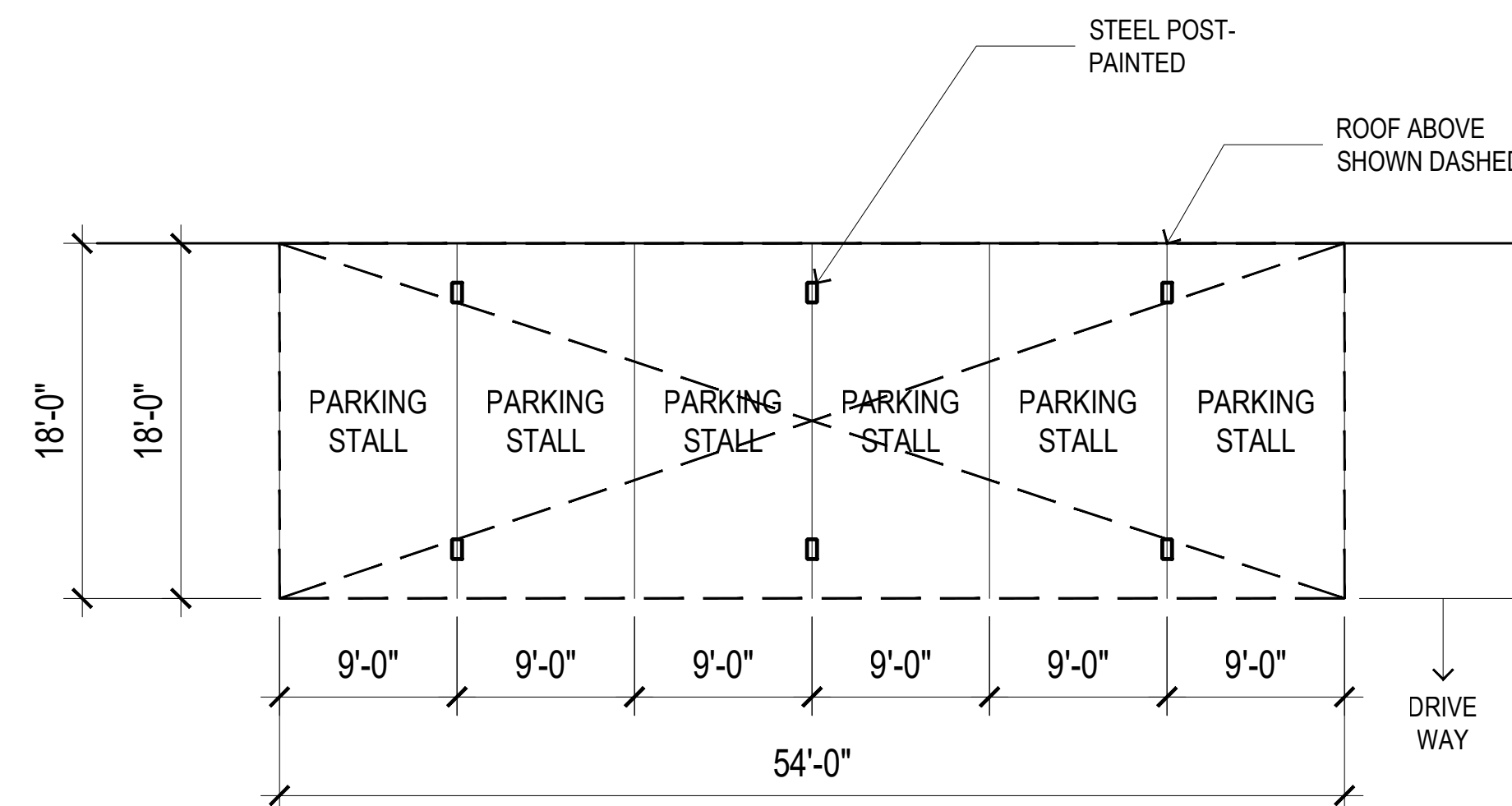

STANDARD CARPORT PLAN (TYP.) 3

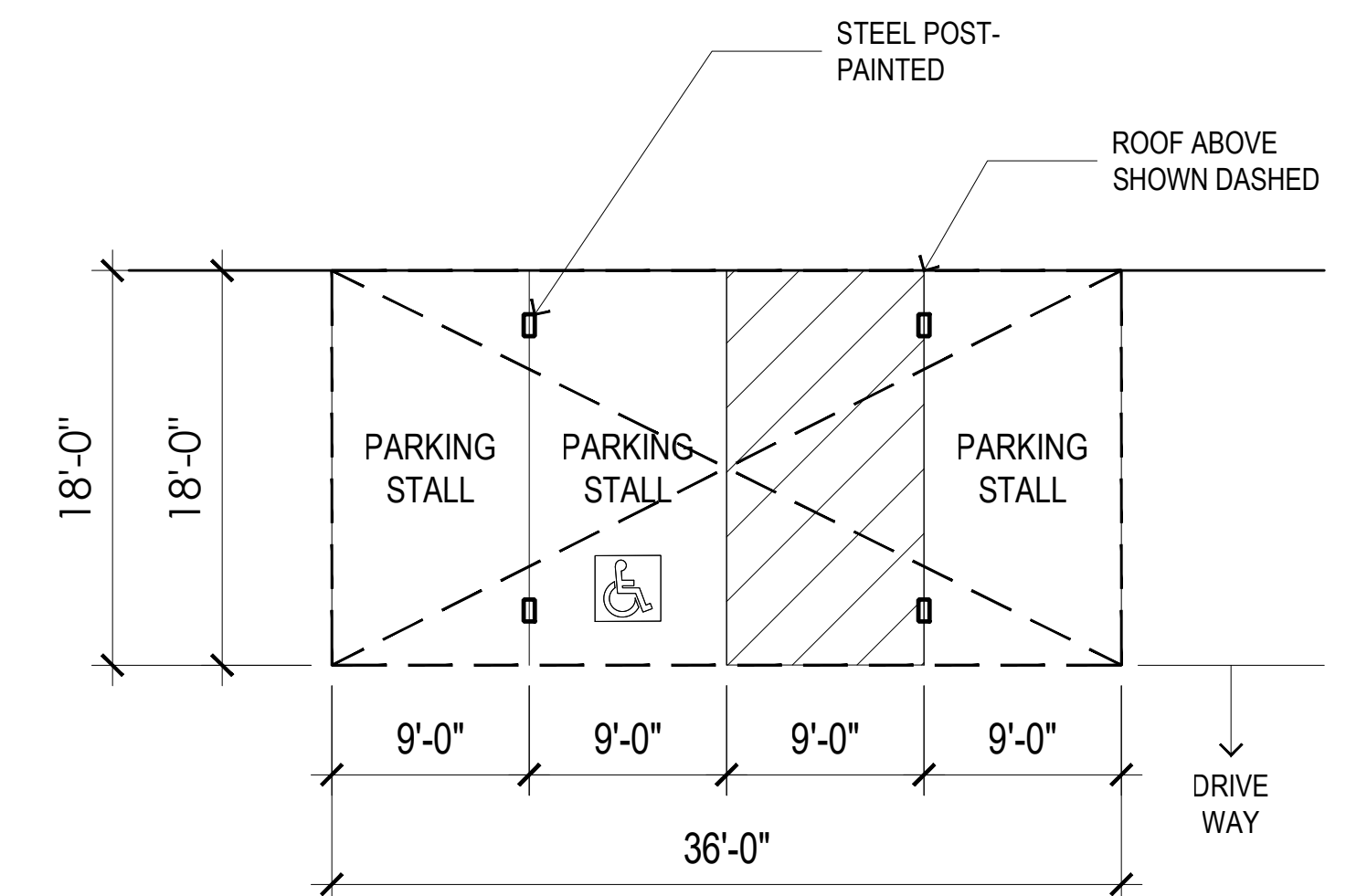

ADA CARPORT PLAN (TYP.) 4